

# Mecmesin

testing to perfection

## Digital Force & Torque Gauges



# Advanced Force Gauge

## Outstanding accuracy combined with extensive features

The Advanced Force Gauge (AFG) is the most versatile and fully-featured digital force gauge on the market. It can be used hand-held or fixed to a manual or motorised test stand to allow testing under controlled speed conditions. The AFG is fitted with a high-precision “internal” loadcell accurate to  $\pm 0.1\%$  of full scale. For added flexibility the AFG is able to recognise data from a range of external ‘Smart’ force and torque sensors, so you can use it as a universal display for remote applications (see pages 5 to 10).

### Key Features:

- Accuracy  $\pm 0.1\%$  of full-scale
- 10 capacities - from 2.5 N to 2500 N
- Peak capture - Ultimate max + 1st peak
- Data output - RS232, digimatic and analogue
- Pass/Fail Alarms - audible and visual
- Overload warning with trend bar
- Wide range of grips and fixtures

**RS232, Mitutoyo, Analogue data output** for easy data transmission. A calibrated analogue output can be supplied as an option

 RS232 to Bluetooth adaptor (optional extra)

**Recognises data from a range of external force & torque transducers** see pages 5-10

**View the 1st peak and ultimate peak readings**  
On-board memory stores up to 500 readings

**Highly Accurate to  $\pm 0.1\%$  full-scale**

**Internal loadcell stud for quick and easy change of accessories and fixtures.** Loadcell stud 10-32 UNF male (5/16 UNC male for AFG 1000 N & 2500 N)

**Audible & visual pass/fail alarms** set a threshold for immediate alert when limits are exceeded

**Measurements made in N, kN, mN, lbf, ozf, kgf and gf** with a sampling rate of 5000 Hz

**Reversible display** - view readings even when the gauge is positioned away from you

**Rugged metal housing** ideal for factory or outdoor use



## AFG Specification Table - Capacity & Resolution (eg 250 N x 0.05 N)

Model	Part No.	mN	N	kN	gf	kgf	ozf	lbf
AFG 2.5	850-412	2500 x 0.5	2.5 x 0.0005	-	250 x 0.05	-	9 x 0.002	0.55 x 0.0001
AFG 5	850-413	5000 x 1	5 x 0.001	-	500 x 0.1	0.5 x 0.0001	18 x 0.005	1.1 x 0.0002
AFG 10	850-414	10000 x 2	10 x 0.002	-	1000 x 0.2	1 x 0.0002	35 x 0.01	2.2 x 0.0005
AFG 25	850-415	25000 x 5	25 x 0.005	-	2500 x 0.5	2.5 x 0.0005	90 x 0.02	5.5 x 0.001
AFG 50	850-416	50000 x 10	50 x 0.01	-	5000 x 1	5 x 0.001	180 x 0.05	11 x 0.002
AFG 100	850-417	-	100 x 0.02	-	10000 x 2	10 x 0.002	350 x 0.1	22 x 0.005
AFG 250	850-418	-	250 x 0.05	-	25000 x 5	25 x 0.005	900 x 0.2	55 x 0.01
AFG 500	850-419	-	500 x 0.1	-	50000 x 10	50 x 0.01	1800 x 0.5	110 x 0.02
AFG 1000	850-420	-	1000 x 0.2	1 x 0.0002	-	100 x 0.02	3500 x 1	220 x 0.05
AFG 2500	850-421	-	2500 x 0.5	2.5 x 0.0005	-	250 x 0.05	9000 x 2	550 x 0.1

- Accuracy  $\pm 0.1\%$  of full scale
- Full scale deflection of loadcell typically 0.5 mm
- Operating temperature 10°C - 35°C

AFG shown mounted to the MultiTest-*d* motorised test stand



The dual level design of the keypad ensures that operation of this powerful gauge is simple, thereby making it ideal for use from production shop floor to R&D.

Housed in an ergonomically shaped, rugged aluminium case, the AFG is powered by either mains-adaptor or standard rechargeable AAA batteries.

All models carry CE marking and are supplied in a robust carrying case with standard accessories and a calibration certificate traceable to UK national standards.

See page 14 for details of accessories supplied.

versatile  
rugged  
accurate



Pull test on anchorage points

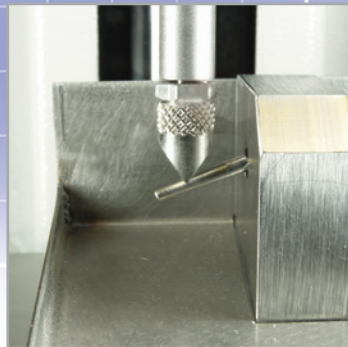

Compression test on medical device



AFG and accessories shown in carry case

# Advanced Force & Torque Indicator

All the functions of the AFG but without the “internal” loadcell

The Advanced Force & Torque Indicator (AFTI) is a high-specification display unit with all the features and benefits of the AFG, for use with Mecmesin ‘Smart’ force and torque sensors. These plug one-at-a-time into the AFTI enabling it to automatically register either force or torque sensors for a variety of test applications. ‘Smart’ sensors may also be used with Mecmesin’s Advanced Force Gauge (AFG).

**Force**

- Image of a force sensor
- Image of a force sensor
- Image of a force sensor

**Torque**

- Image of a torque sensor
- Image of a torque sensor
- Image of a torque sensor

**RS232, Mitutoyo, Analogue data output** for easy data transmission

Bluetooth RS232 to Bluetooth adaptor (optional extra)

Measurements made in **N, lbf, kgf, kN, N.m, kgf.cm, lbf.in, gf.cm and ozf.in** with a sampling rate of 5000 Hz

Overload warning with **trend bar** and on board memory of 500 readings

Fully interchangeable ‘Smart’ sensors - No need for additional calibration of display or sensor, just ‘Plug & Play’

Tension, compression and torque measurement with full unit conversion of displayed value

1st & ultimate peak capture

The AFTI device features a digital display showing 0.646 N.m, a trend bar, and buttons for MAX/ESC, UNITS/MENU, RESET/ENTER, TXD UP, and ZERO/DOWN. The device is labeled 'Mecmesin' and 'AFTI ADVANCED FORCE & TORQUE INDICATOR'.

These sensors are ideal for mounting onto your own test rigs and jigs to monitor load application. They can also be used for checking calibration of your machinery to assess whether it is applying the expected load.

## 'Smart' Force & Torque Sensors

All sensors are fitted with 1.5 m cable length, are fully interchangeable and are supplied with Calibration Certificates traceable to UK National Standards. As standard they are delivered in cardboard transit cases.

### Key Features:

- Sensors for torque, tension & compression
- Calibration Certificates traceable to UK National Standards
- Resolution - 1:5000
- Overload warning feature
- 1.5 m cable length as standard - longer cable available upon request

# force & torque plug-in sensors adaptable

All dimensions quoted for the force and torque sensors are for reference only. Please contact the Mecmesin Sales Department for tolerance information if your application is dimensionally critical.

Overload protection by software warning is typically 120% of full scale for all items (without accessories), with additional mechanical overload protection being up to a minimum of 150% of full scale.

All gauges and sensors are calibrated under controlled laboratory conditions at a temperature of  $20^{\circ}\text{C} \pm 2^{\circ}\text{C}$ . Resolution for all sensors is typically 1:5000 - e.g. a 5000 N loadcell resolves to 1 N.

## Bluetooth/USB Adaptor

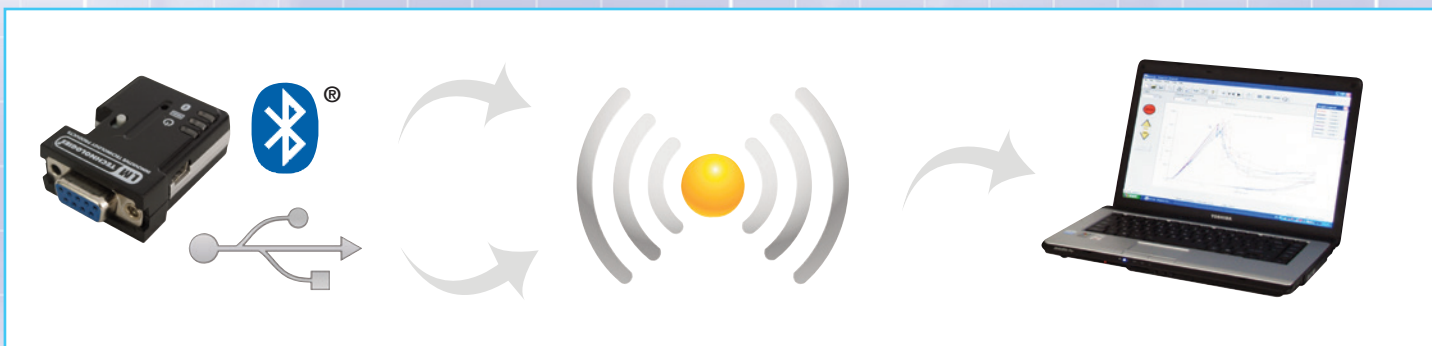

- Cableless Communication
- Range in excess of 30 metres
- Easy-to-use, just 'Plug & Play'
- Maximum flexibility for data transfer
- Connects to AFG & AFTI

# Tension & Compression Sensors

“Smart” Sensors for use with AFTI display or Advanced Force Gauge (AFG)

## Junior S-Beam - ‘Smart’

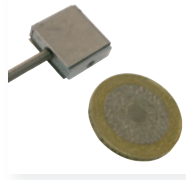

The Junior S-Beam is suitable for measuring tension and compression. Ideal for applications where available space is limited. Dedicated fixtures can be fitted via threaded holes.

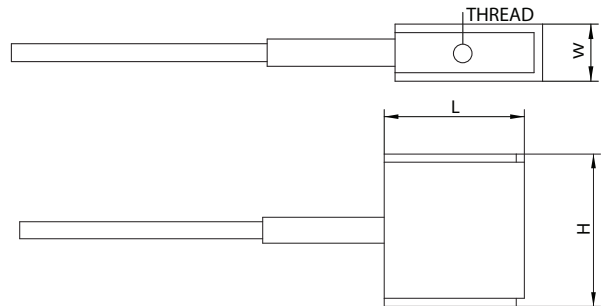

Model	Part No.	L (mm)	W (mm)	H (mm)	Thread
1 N 100 gf 3.5 ozf	870-101	17	7	19	M3 x 0.5
2.5 N 250 gf 9 ozf	870-102	17	7	19	M3 x 0.5
5 N 500 gf 18 ozf	870-103	17	7	19	M3 x 0.5
10 N 1 kgf 2.2 lbf	870-104	17	7	19	M3 x 0.5
25 N 2.5 kgf 5.5 lbf	870-105	17	7	19	M3 x 0.5
50 N 5 kgf 11 lbf	870-106	17	7	19	M3 x 0.5
100 N 10 kgf 22 lbf	870-107	17	7	19	M3 x 0.5
250 N 25 kgf 55 lbf	870-108	17	7	19	M3 x 0.5
500 N 50 kgf 110 lbf	870-109	17	7	19	M3 x 0.5

Accuracy  $\pm 0.25\%$  of full scale



## S-Beam - ‘Smart’

The S-Beam provides an economical solution to general force measurement applications where space is not restricted. Dedicated fixtures can be fitted via threaded holes.

Model	Part No.	L (mm)	W (mm)**	H (mm)	Thread
100 N 10 kgf 22 lbf	870 - 002	51	13	64	M6 x 1
200 N 20 kgf 44 lbf	870 - 004	51	13	64	M6 x 1
500 N 50 kgf 110 lbf	870 - 009	51	19	76	M6 x 1
1000 N 100 kgf 220 lbf	870 - 001	51	19	76	M10 x 1.5
2500 N 250 kgf 550 lbf	870 - 006	51	25	76	M12 x 1.75
5000 N 500 kgf 1100 lbf	870 - 008	51	25	76	M12 x 1.75
10 kN 1000 kgf 2200 lbf	870 - 003	51	25	76	M12 x 1.75
25 kN 2500 kgf 5500 lbf	870 - 007	76	25	108	M16 x 2

Cylindrical	Part No.	Ø (mm)	H (mm)	Thread
*50 kN 5000 kgf 11000 lbf	870 - 011	70	120	M36 x 3
*100 kN 10000 kgf 22000 lbf	870 - 010	70	120	M36 x 3

Accuracy  $\pm 0.25\%$  of full scale \* Uni-directional calibration (please specify tension or compression)

### S-Beam

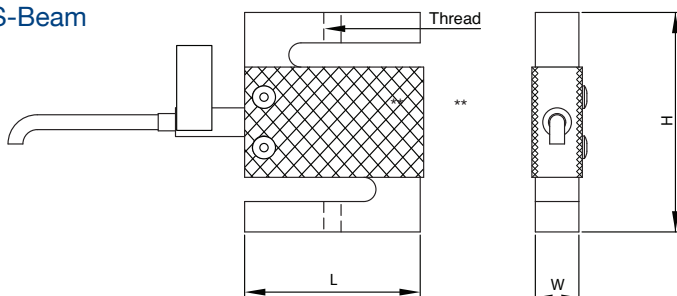

### Cylindrical

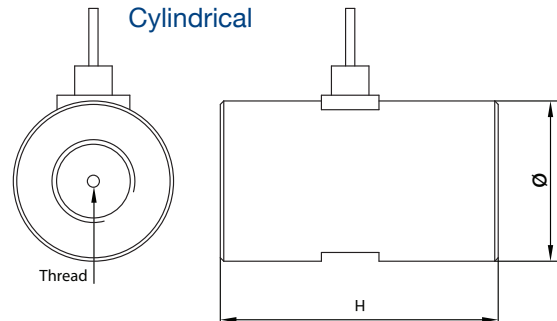

\*\* 6mm added to the overall width of the central portion due to the protective cover

# Compression Only Sensors



## Load Button Cell - 'Smart'

The Load Button Cell is a miniature sensor for compression measurement only, where available space is very limited. For optimum results apply compressive load to the top of the sensor's central dome.

### Miniature Series

Model	Part No.	Capacity					ØD1 (mm)	ØD2 (mm)	ØD3 (mm)	H1 (mm)	H2 (mm)	T	
L16010	878 - 008	100	N	10	kgf	22	lbf	25	5	19	8	1	4/40UNC
	878 - 009	250	N	25	kgf	55	lbf	25	5	19	8	1	4/40UNC
	878 - 010	500	N	50	kgf	110	lbf	25	5	19	8	1	4/40UNC
L16020	878 - 011	1000	N	100	kgf	220	lbf	31	8	25	10	1	6/32UNC
	878 - 012	2500	N	250	kgf	550	lbf	31	8	25	10	1	6/32UNC
	878 - 013	5000	N	500	kgf	1100	lbf	31	8	25	10	1	6/32UNC
	878 - 014	10	kN	1000	kgf	2200	lbf	31	8	25	10	1	6/32UNC
L16030	878 - 015	20	kN	2000	kgf	5500	lbf	38	11	32	16	2	6/32UNC
	878 - 016	50	kN	5000	kgf	11000	lbf	38	11	32	16	2	6/32UNC

Accuracy  $\pm 1\%$  of full scale

### Sub-miniature Series

Model	Part No.	Capacity					ØD1 (mm)	ØD2 (mm)	H1 (mm)	H2 (mm)	
L1630	878 - 002	100	N	10	kgf	22	lbf	19	4.5	7	0.5
	878 - 003	250	N	25	kgf	55	lbf	19	4.5	7	0.5
	878 - 004	500	N	50	kgf	110	lbf	19	4.5	7	0.5
	878 - 005	1000	N	100	kgf	220	lbf	19	4.5	7	0.5
	878 - 006	5000	N	500	kgf	1100	lbf	19	4.5	7	0.5

Accuracy  $\pm 1\%$  of full scale

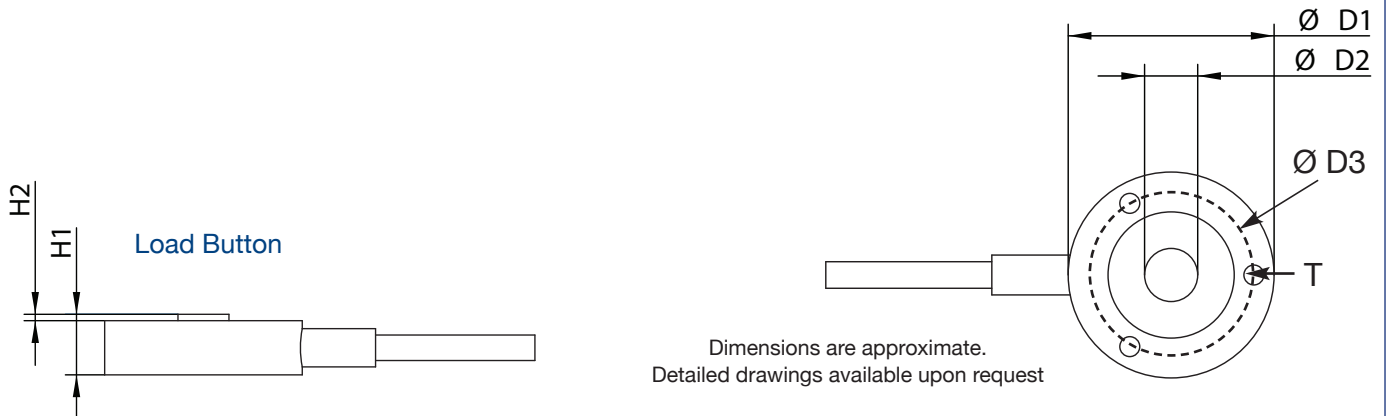

# Static Torque Sensors

“Smart” Sensors for use with AFTI display or Advanced Force Gauge (AFG)



## Static Torque Transducer – ‘Smart’ (low-torque)

For mounting to a bench or integrating into a complete test rig.  
Equipped with ¼” HEX Socket or 3mm bore for fitting of adaptors.

Model	Part No.	Capacity			Drive		H (mm)	W (mm)	D (mm)
TT-ST0.05	872 - 030	50 mN.m	500 gf.cm	7 ozf.in	Bore Ø3 H7		75	50	50
TT-ST0.20	872 - 032	200 mN.m	2000 gf.cm	28 ozf.in	Bore Ø3 H7		75	50	50
TT-ST0.50	872 - 033	500 mN.m	5 kgf.cm	4.5 lbf.in	¼” HEX Socket		91	50	50
TT-ST1	872 - 034	1 N.m	10 kgf.cm	9 lbf.in	¼” HEX Socket		91	50	50
TT-ST2	872 - 035	2 N.m	20 kgf.cm	18 lbf.in	¼” HEX Socket		91	50	50

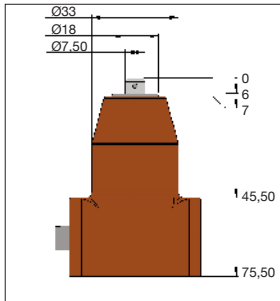

Side view of  
TT-ST0.05 and TTST0.20  
(Ø3 H7 bore)

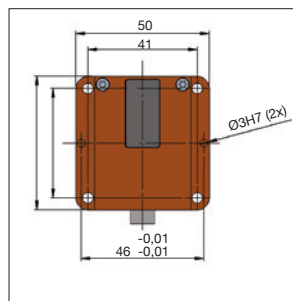

Top View of all TT models

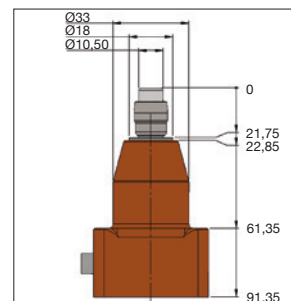

Side view of  
TT-ST0.50, TT1 and TT-ST2  
(¼” HEX Socket)

Accuracy ±0.5% of full scale



## Static Torque Transducer - ‘Smart’ (mid & high-torque)

For mounting to a bench or integrating into a complete test rig.  
Equipped with male square drive for easy fitting of adaptors.

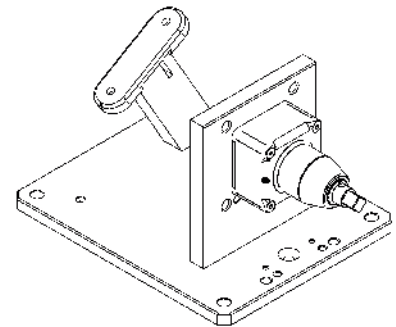
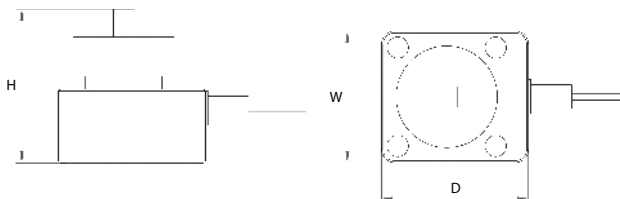

Bench Mounting Stand  
Part No 432-401 suitable for ‘mid & high-torque’  
ST Torque Sensors

Model	Part No.	Capacity			Sq Drive Male		H (mm)	W (mm)	D (mm)
ST1.5	872 - 001	1.5 N.m	15 kgf.cm	13 lbf.in	1/2”		87	80	90
ST6	872 - 009	6 N.m	60 kgf.cm	53 lbf.in	1/2”		87	80	90
ST10	872 - 004	10 N.m	100 kgf.cm	90 lbf.in	1/2”		87	80	90
ST15	872 - 006	15 N.m	150 kgf.cm	133 lbf.in	3/8”		87	80	90
ST60	872 - 008	60 N.m	600 kgf.cm	530 lbf.in	3/8”		87	80	90
ST100	872 - 003	100 N.m	1000 kgf.cm	870 lbf.in	1/2”		93	80	90
ST150	872 - 005	150 N.m	1500 kgf.cm	1300 lbf.in	1/2”		93	80	90
ST600	872 - 007	600 N.m	6000 kgf.cm	5200 lbf.in	3/4”		113.5	78.7	100
ST1000	872 - 002	1000 N.m	10000 kgf.cm	8850 lbf.in	1”		124	78.7	100

Accuracy ±0.5% of full scale





## Static 'Mini' Torque Screwdriver - 'Smart' (low-torque)

For hand-held applications requiring the measurement of miniature torque below 1 N.m.

Not suitable for applications, which require multiple rotations of the sensor - use Rotary Torque Transducers (see page 9).

Model	Part No.	Capacity			Drive	L1 (mm)	Ø (mm)
TTH0.01	871 - 100	10 mN.m	100 gf.cm	1 ozf.in	Bore Ø3 H7	135	22
TTH0.05	871 - 101	50 mN.m	500 gf.cm	7 ozf.in	Bore Ø3 H7	135	22
TTH0.10	871 - 102	100 mN.m	1000 gf.cm	14 ozf.in	Bore Ø3 H7	135	22
TTH0.20	871 - 105	200 mN.m	2000 gf.cm	28 ozf.in	Bore Ø3 H7	135	22
TTH0.50	871 - 103	500 mN.m	5 kgf.cm	4.5 lbf.in	¼" HEX Socket	151	22
TTH1	871 - 104	1 N.m	10 kgf.cm	9 lbf.in	¼" HEX Socket	151	22

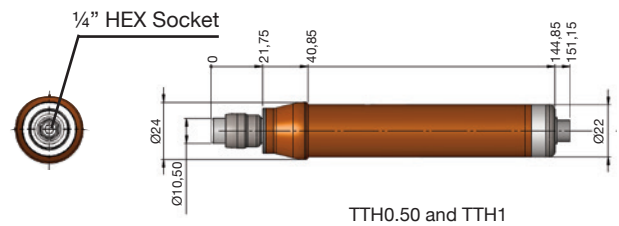
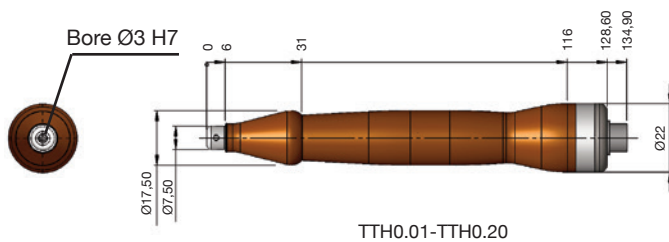

Accuracy ±0.5% of full scale

## Static Torque Screwdriver - 'Smart' (mid-torque)

For mid capacity applications. Used as hand-held devices or may be mounted in a bench stand for stationary use Part No 432-402. Not suitable for applications, which require multiple rotations of the sensor - use Rotary Torque Transducers (see page 9).

Model	Part No.	Capacity			Drive	L (mm)	Ø (mm)	Weight (g)
TS0.3	871-004	0.3 N.m	3 kgf.cm	2.6 lbf.in	3/8" sq male/3 jaw chuck	143	43	660
TS1.5	871-002	1.5 N.m	15 kgf.cm	13 lbf.in	3/8" sq male/3 jaw chuck	143	43	660
TS3	871-003	3 N.m	30 kgf.cm	26 lbf.in	3/8" sq male/3 jaw chuck	143	43	660
TS6	871-005	6 N.m	60 kgf.cm	53 lbf.in	3/8" sq male/3 jaw chuck	143	43	660
TS10	871-001	10 N.m	100 kgf.cm	90 lbf.in	3/8" sq male/3 jaw chuck	143	43	660

Supplied as standard with both 3/8" sq male drive & 3/8" opening 3 jaw chuck

Part No 432-113 1/2" opening Chuck Assembly for use with 'TS' Torque Screwdriver (optional extra)

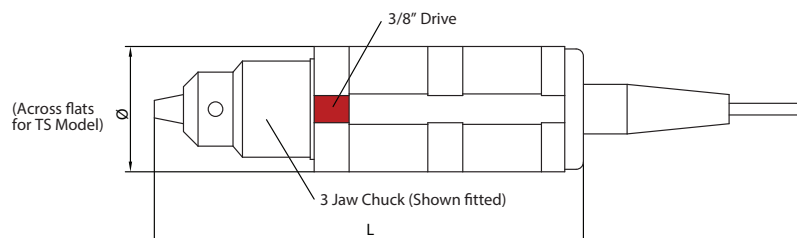
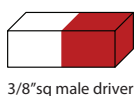

Accuracy ±0.5% of full scale

# Rotary Torque Sensors

“Smart” Sensors for use with AFTI display or Advanced Force Gauge (AFG)

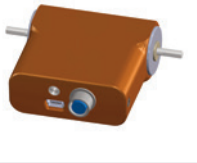

## Mini Rotary Torque Transducers- ‘Smart’ (low-torque)

A complete range of mini sensors for measuring rotary torque below 1 N.m.

### ‘Mini’ (low-torque) TTR range

Model	Part No.	Capacity			A Shaft Length (mm)	B Shaft Ø (mm)
TTR0.05	877 - 030	50 mN.m	500 gf.cm	7 ozf.in	11.2	Ø 3h8
TTR0.10	877 - 031	100 mN.m	1000 gf.cm	14 ozf.in	10.4	Ø 5h8
TTR0.20	877 - 032	200 mN.m	2000 gf.cm	28 ozf.in	10.4	Ø 5h8
TTR0.50	877 - 033	500 mN.m	5 kgf.cm	4.5 lbf.in	17.75	Ø 8h8
TTR1	877 - 034	1 N.m	10 kgf.cm	9 lbf.in	17.75	Ø 8h8

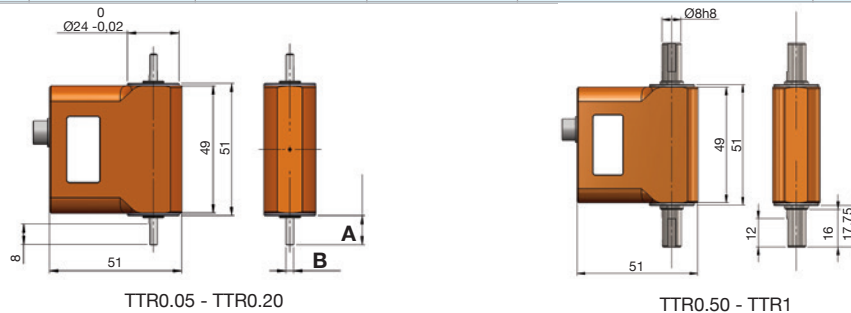

Accuracy ±0.5% of full scale

## Rotary Torque Transducers - ‘Smart’ (mid & high-torque)

A complete range of sensors for measuring rotary torque. Suitable for dynamic torque applications with multiple revolutions (e.g. window-winder mechanism).

### ‘FAST’ (mid and high torque) range

Model	Part No.	Capacity			Drive	L1 (mm)	L2 (mm)	L3 (mm)	Ø (mm)	Max rpm
FAST 2 N.m sq	877 - 020	2 N.m	20 kgf.cm	18 lbf.in	1/4" square	70	16	10	40	1000
FAST 2 N.m rd	877 - 021	2 N.m	20 kgf.cm	18 lbf.in	Ø 9mm round*	70	28	28	40	5000
FAST 6 N.m sq	877 - 022	6 N.m	60 kgf.cm	53 lbf.in	1/4" square	70	16	10	40	1000
FAST 6 N.m rd	877 - 023	6 N.m	60 kgf.cm	53 lbf.in	Ø 9mm round*	70	28	28	40	5000
FAST 15 N.m sq	877 - 024	15 N.m	150 kgf.cm	133 lbf.in	1/4" square	70	16	10	40	1000
FAST 15 N.m rd	877 - 025	15 N.m	150 kgf.cm	133 lbf.in	Ø 9mm round*	70	28	28	40	5000
FAST 60 N.m sq	877 - 026	60 N.m	600 kgf.cm	530 lbf.in	3/8" square*	70	24	13	50	1000
FAST 60 N.m rd	877 - 027	60 N.m	600 kgf.cm	530 lbf.in	Ø 14mm round*	70	28	28	50	5000
FAST 150 N.m sq	877 - 028	150 N.m	15.3 kgf.m	111 lbf.ft	1/2" square	70	35	19	50	1000
FAST 150 N.m rd	877 - 029	150 N.m	15.3 kgf.m	111 lbf.ft	Ø 19mm round*	70	55	55	50	5000

- Maximum axial force is 40 N • Maximum lateral radial force is 50 N
- Accuracy ±1% of full scale
- \* fitted with keyway

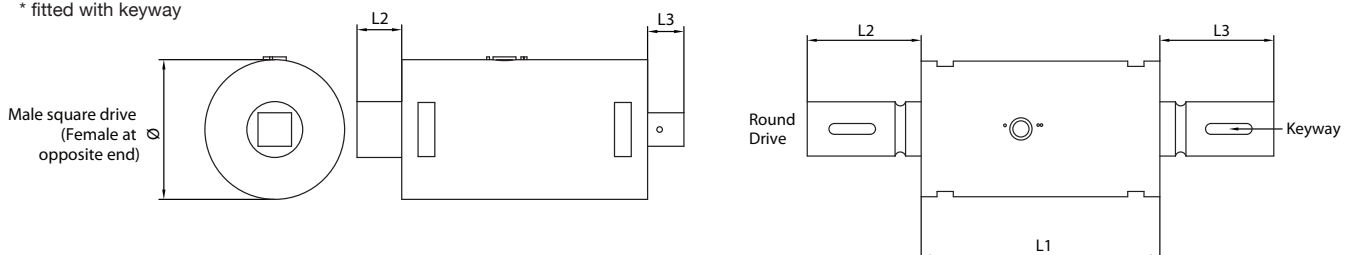

# Specialised Loadcells

## Specialised Loadcells - 'Smart'

In addition to the standard range of sensors, Mecmesin also offers specialised loadcells dedicated to specific applications. A few examples are shown below. Contact our sales department for further details.

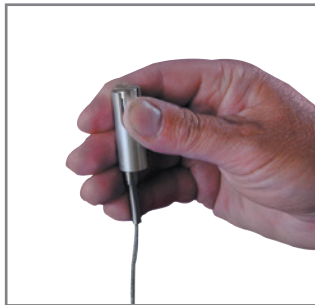

Pinch Sensor

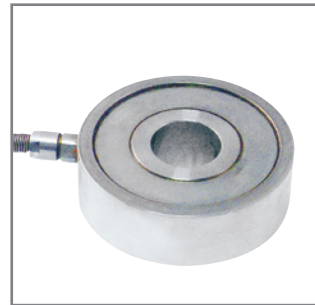

Donut Loadcell

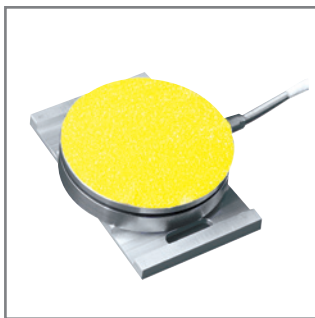

Pedal Force Accelerator

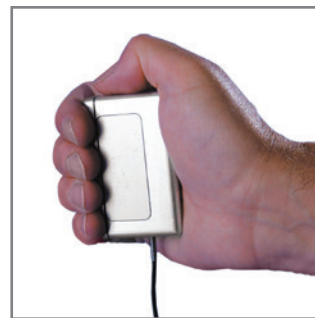

Hand Gripper



Pedal Force Accelerator in action

# Basic Force Gauge

## “Live” and “Peak Hold” display with data-output in metal housing

The Basic Force Gauge (BFG) is designed for easy operation and provides outstanding tension and compression measurement performance and reliability at an affordable price.

Supplied as standard with calibration certificate traceable to national standards.

Constructed in a rigid yet lightweight aluminium housing, with its ergonomically attractive shape, the BFG can be used as a hand-held instrument, or alternatively it can be mounted to manual or motorised test stands to allow testing under more controlled conditions.



## BFG Specification Table - Capacity & Resolution (e.g. 200 N x 0.05 N)

Model	Part No.	mN	N	kN	gf	kgf	ozf	lbf
BFG 10	853-410	10000 x 2	10 x 0.002	-	1000 x 0.2	1 x 0.0002	35 x 0.01	2.2 x 0.0005
BFG 50	853-411	50000 x 10	50 x 0.01	-	5000 x 1	5 x 0.001	180 x 0.05	11 x 0.002
BFG 200	853-412	-	200 x 0.05	-	20000 x 5	20 x 0.005	720 x 0.2	44 x 0.01
BFG 500	853-413	-	500 x 0.1	-	50000 x 10	50 x 0.01	1800 x 0.5	110 x 0.02
BFG 1000	853-414	-	1000 x 0.2	1 x 0.0002	-	100 x 0.02	3500 x 1	220 x 0.05
BFG 2500	853-417	-	2500 x 0.5	2.5 x 0.0005	-	250 x 0.05	9000 x 2	550 x 0.1

- Accuracy  $\pm 0.25\%$  of full scale
- Full scale deflection of loadcell typically 0.5 mm
- Operating temperature 10°C - 35°C

### Key Features

- Accuracy  $\pm 0.25\%$  of full range
- 6 capacities - from 10 N up to 2500 N
- Peak capture - in tension and compression
- Wide range of grips and fixtures

easy-to-use  
ergonomic  
robust



BFG shown mounted to the MDD manual test stand

All models carry CE marking and are supplied in a robust carrying case with standard accessories and a calibration certificate traceable to UK national standards.

See page 14 for details of accessories supplied.



BFG with accessories shown in carry case

# Compact Force Gauge<sup>+</sup>

## “Peak Hold” display in ABS plastic housing

The Compact Force Gauge<sup>+</sup> (CFG<sup>+</sup>) is a pocket-sized, lightweight force gauge designed for elementary tension and compression measurement. Powered by disposable AA batteries, the CFG<sup>+</sup> is delivered with a Declaration of Conformity as standard. A Calibration Certificate can be ordered separately.

Peak readings captured at 500 Hz with an accuracy of  $\pm 0.5\%$  of full scale

low cost  
peak hold  
portable

Measurements made in N, lbf, ozf, kgf and gf with a resolution of 1:1000

Housed in a lightweight plastic case

Loadcell stud 10-32 UNF male

RS232 output for easy data transmission

The CFG<sup>+</sup> provides a simple digital alternative to traditional analogue spring balances. It is ideal for users with a limited budget, who only measure on an occasional basis for non-critical applications.

## CFG<sup>+</sup> Specification Table

Model	Part No.	N	kgf	lbf
CFG <sup>+</sup> 50	860-021	50 x 0.05	5 x 0.005	11 x 0.01
CFG <sup>+</sup> 200	860-022	200 x 0.2	20 x 0.02	44 x 0.05
CFG <sup>+</sup> 500	860-023	500 x 0.5	50 x 0.05	110 x 0.1

• Accuracy  $\pm 0.5\%$  of full scale

Note: The following units are available on the majority of CFG<sup>+</sup> models.

Those that differ are marked by an asterisk with details given below:

kN\*, N, mN, kgf, gf\*\*, lbf, ozf

\* Not available on the CFG<sup>+</sup> 50 N

\*\* Not available on the CFG<sup>+</sup> 200 N or 500 N



Hand-held drawer testing

# Accessories

Each Mecmesin gauge comes with a set of standard accessories to help perform basic tension or compression tests.

A wide selection of accessories exclusive to Mecmesin are available. See our Accessory Catalogue for an extensive range of grips and fixtures, to enable you to complete thousands of different tests. Alternatively make use of our experienced team of engineers to provide a customised grip to solve your particular problem.

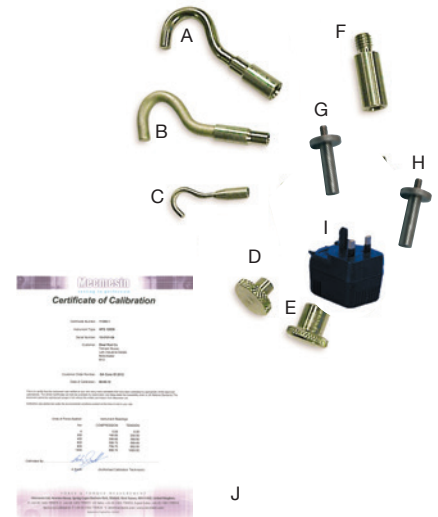

- A** 6 mm Ø - 5/16 UNC thread (432-122)
- B** 6 mm Ø - 10-32 UNF (F) (432-120)
- C** 3.2 mm Ø - 10-32 UNF (F) (432-118)
- D** 19 mm Ø - 10-32 UNF (F) (432-121)
- E** 19 mm Ø - 5/16 UNC (F) (432-125)

- F** 30 mm long - 5/16 UNC (F-M) (432-008)
- G** 30 mm - 10-32 UNF (F) to 10-32 UNF (M) (432-006)
- H** 30 mm - 10-32 UNF (F) to M6 (M) (432-007)
- I** Mains adaptor/charger (304-004) - 220V 2-pin round (304-005) - 220V 3-pin square (304-006) - 110V 2-pin flat
- J** Calibration certificate traceable to national standards

\* Part numbers shown in brackets

Table of standard accessories delivered with each gauge:

Model	Capacity	A	B	C	D	E	F	G	H	I	J
AFG	2.5, 5, 10, 25, 50 N			•	•			•	•	•	•
AFG	100, 250, 500 N		•		•			•	•	•	•
AFG	1000, 2500 N	•				•	•			•	•
BFG	10, 50 N			•	•			•	•	•	•
BFG	200, 500 N		•		•			•	•	•	•
BFG	1000, 2500 N	•				•	•			•	•
CFG+	50 N			•	•			•	•		
CFG+	200 N		•		•			•	•		
CFG+	500 N		•		•			•	•		

## Service & Calibration

Mecmesin ensures all customers receive a high level of on-going service and support. This includes offering a prompt and cost-effective calibration service. Though calibrations can be completed in our comprehensive in-house facility, customers also have the option of our on-site calibration service.

