

# Rotary Limit Switch RLS4C



The rotary limit switch is used to control the movement of industrial machinery. It operates as an auxiliary controller of electrical motors through a power interface, such as a contactor or PLC. Suitable for heavy duty, its shaft is connected to the motor and, after a set number of revolutions, the cams operate the switches, thus starting the predetermined movement. A worm gear and a helical toothed gear combined with one or more pairs of straight toothed gears are used for the transmission of the movement from the input shaft to the output shaft.

Revolution ratios, ranging from 1:1 to 1:969, result from the use of different combinations of gear wheels between the input shaft and the output shaft, which is connected to the cams operating the switches.

Transmission and gear driving shafts are made of stainless steel to prevent oxidation and wear. The gear wheels and the driving bushes are made of self-lubricating thermoplastic material, suitably chosen to reduce the wear to a minimum and to maintain the accuracy of the couplings over time. Sintered bronze bushes are moulded into the base of the limit switch to optimise the shaft rotation and to prevent rubbing with plastic material.

Each cam can be set with great accuracy thanks to the cam adjusting screws. The auxiliary switches are of a positive opening type, thus suitable for safety functions. It is available with direct control switches for operating directly on the motor.

The cam-switch sets can be substituted for potentiometers suitable for the connection to electronic equipment. Each output of the limit switch can be set with a different revolution ratio to allow for a diversified control of the machinery to meet special requirements.

Materials and components are wear resistant and protect the equipment against water and dust. The limit switch is available with a flange for direct coupling to the motor and it can be customised with labels and colours according to the customer's requirements.

## Technical Specifications

|                                    |  |
|------------------------------------|--|
| Conformity to Community Directives | 73/23/CEE 93/68/CEE  |
| Conformity to Standards            | EN 60204-1 EN 60947-1 EN60947-5-1<br>EN 60529 EN 50013 IEC 536 |
| Ambient temperature                | Storage -40°C/+70°C<br>Operational -25°C/+70°C                 |
| Protection degree                  | IP 65  |
| Insulation category                | Class II   |
| Cable entry                        | Cable clamp M20  |

## Technical Specifications of the Switches

|                           |   |
|---------------------------|---|
| Utilisation category      | AC 15                                       |
| Rated operational current | 3 A   |
| Rated operational voltage | 250 V                                       |
| Rated thermal current     | 10 A  |
| Rated insulation voltage  | 300 V~                                      |
| Mechanical life           | 1x10 <sup>6</sup> operations                |
| Terminal referencing      | According to EN 50013                       |
| Connections               | Screw-type terminals with self-lifting pads |

## Standard Limit Switch Codes

| Revolution ratio | Type of contact | 2 switches | 3 switches | 4 switches |
|------------------|-----------------|------------|------------|------------|
| 1:1              | Snap            | MY00010003 | MY00010002 | MY00010001 |
|                  | Slow            | MY00010004 | MY00010005 | MY00010006 |
| 1:5              | Snap            | MY00050002 | MY00050003 | MY00050001 |
|                  | Slow            | MY00050004 | MY00050005 | MY00050006 |
| 1:10             | Snap            | MY00100003 | MY00100004 | MY00100002 |
|                  | Slow            | MY00100005 | MY00100006 | MY00100007 |
| 1:15             | Snap            | MY00150004 | MY00150003 | MY00150002 |
|                  | Slow            | MY00150007 | MY00150008 | MY00150001 |
| 1:20             | Snap            | MY00200002 | MY00200003 | MY00200001 |
|                  | Slow            | MY00200004 | MY00200005 | MY00200006 |
| 1:25             | Snap            | MY00250006 | MY00250003 | MY00250001 |
|                  | Slow            | MY00250007 | MY00250008 | MY00250002 |
| 1:50             | Snap            | MY00500002 | MY00500003 | MY00500006 |
|                  | Slow            | MY00500028 | MY00500017 | MY00500007 |
| 1:75             | Snap            | MY00750007 | MY00750008 | MY00750004 |
|                  | Slow            | MY00750009 | MY00750010 | MY00750006 |
| 1:100            | Snap            | MY01000002 | MY01000006 | MY01000003 |
|                  | Slow            | MY01000001 | MY01000013 | MY01000004 |
| 1:150            | Snap            | MY01500002 | MY01500011 | MY01500008 |
|                  | Slow            | MY01500001 | MY01500009 | MY01500003 |
| 1:200            | Snap            | MY02000006 | MY02000002 | MY02000003 |
|                  | Slow            | MY02000007 | MY02000004 | MY02000008 |
| 1:250            | Snap            | MY02500003 | MY02500007 | MY02500008 |
|                  | Slow            | MY02500009 | MY02500010 | MY02500011 |
| 1:300            | Snap            | MY03000004 | MY03000006 | MY03000007 |
|                  | Slow            | MY03000008 | MY03000009 | MY03000010 |

Standard limit switches are equipped with 2,3 or 4 snap or slow action switches and with pointed cams MY140PI. Other assemblies and revolution ratios are available on request. It is possible to assemble up to 6 switches. Maximum revolution ratio 1:969.

## Overall Dimensions

### Standard Limit Switch

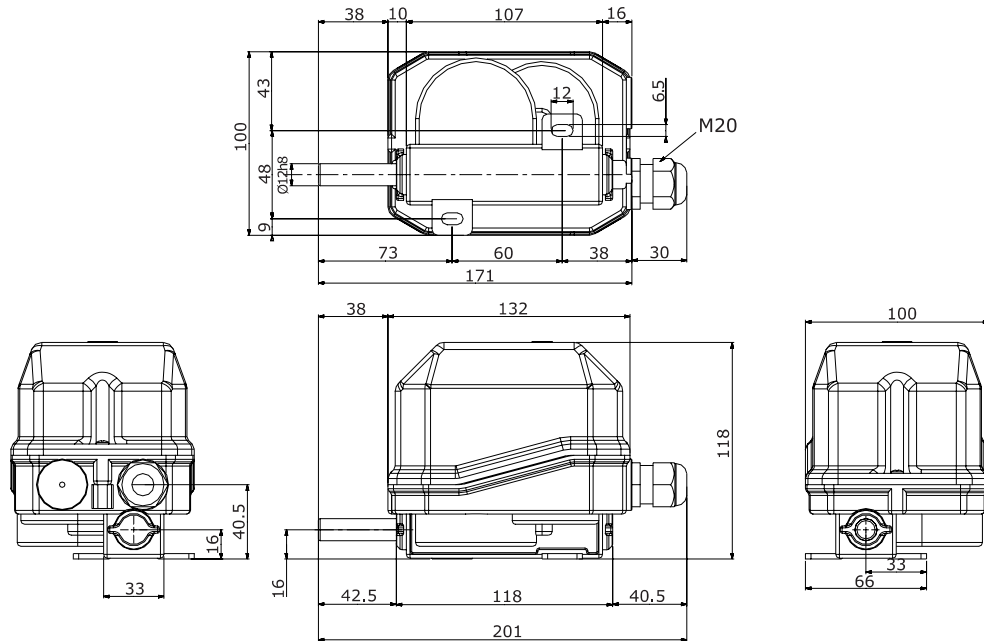



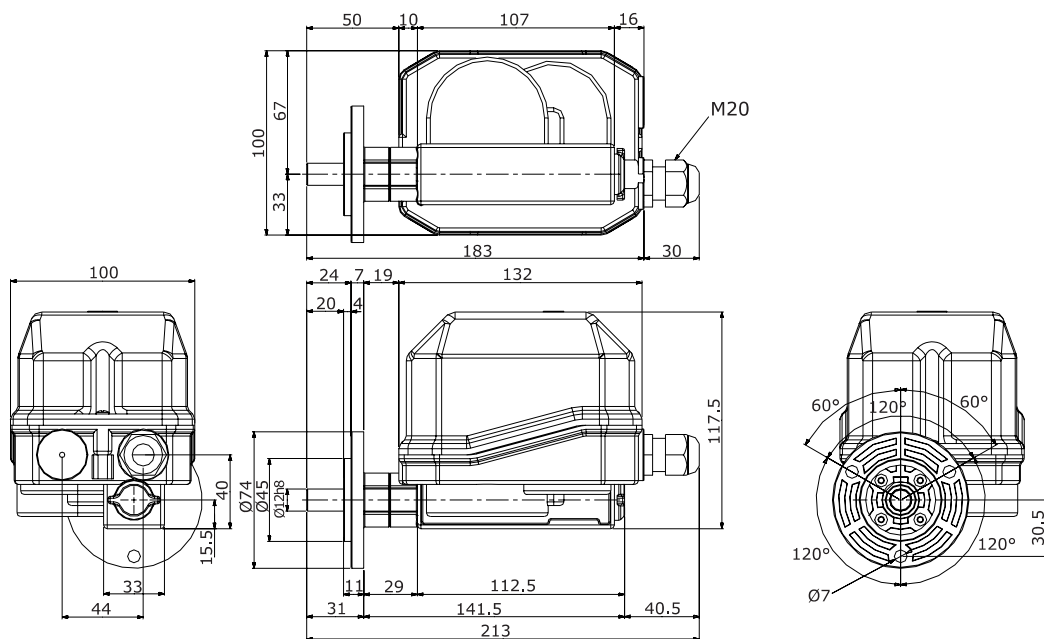



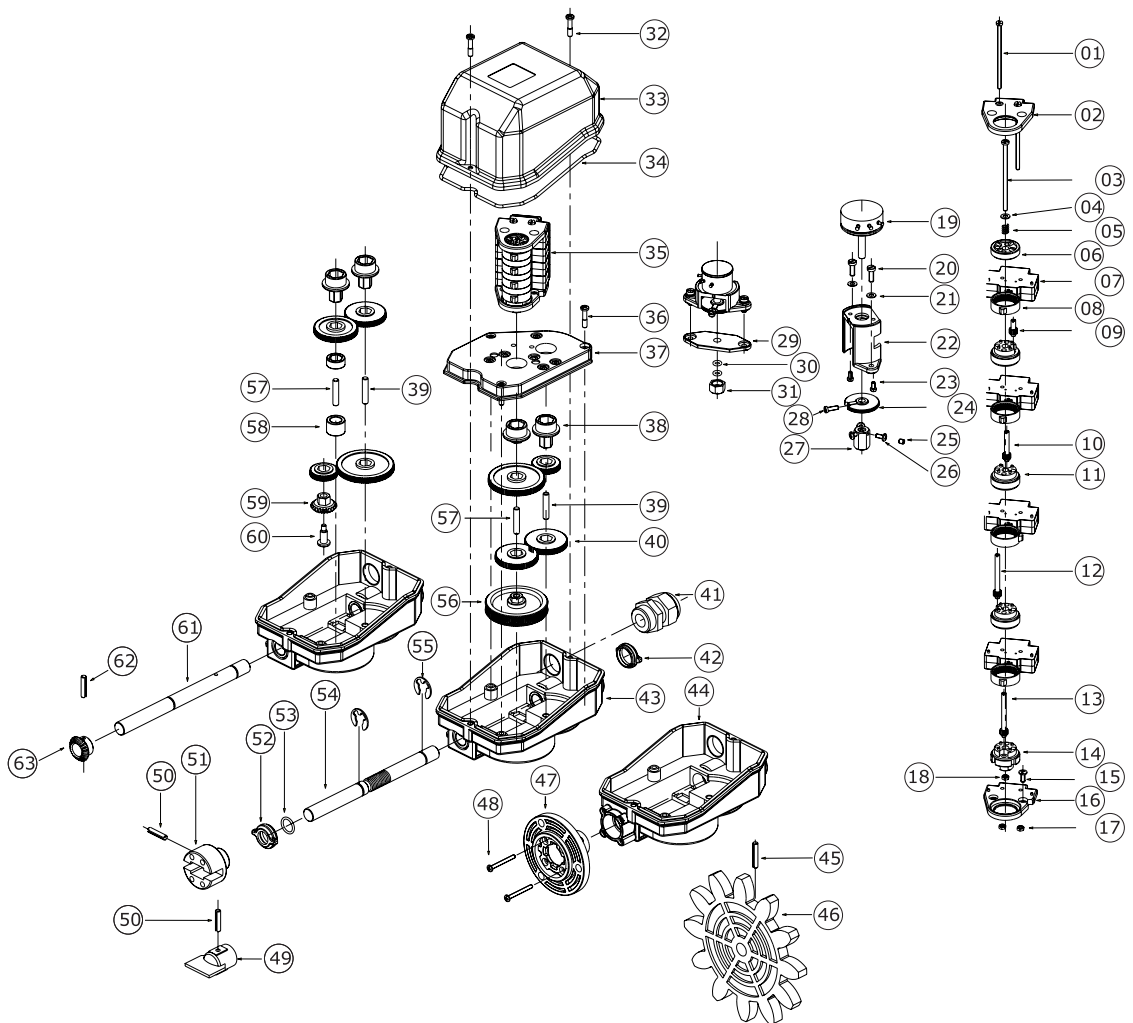





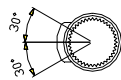
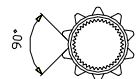
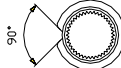

### Limit Switch with Flange







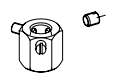
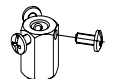
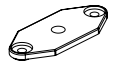

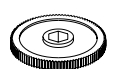
## Detailed Drawing

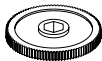
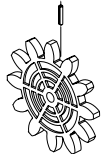
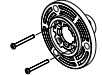

## Parts List

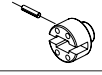
| Reference    | Drawing   | Description  |
|--------------|---|--|
| 07           |    | Snap action switch<br>Slow action switch   |
| 08           |    | Pointed cam  |
| 08           |    | Sector cam   |
| 08           |    | 10 point cam   |
| 08           |    | Circular cam   |
| 08           |    | 180° cam   |
| 19           |    | Potentiometer 4.7 kW with continuous rotation<br>Potentiometer 10 kW with continuous rotation<br>Potentiometer 2.2 kW with continuous rotation |
| 19           |   | Potentiometer MCB 10 kΩ<br>Potentiometer MCB 10 kΩ with continuous rotation  |
| 22<br>+20+21 |  | Small support for potentiometer with O-ring  |
| 22<br>+20+21 |  | Large support for potentiometer  |
| 22<br>+20+21 |  | Medium support for potentiometer   |
| 22<br>+20+21 |  | Medium support for potentiometer   |
| 24<br>+28    |  | Adjusting gear   |
| 27<br>+26    |  | Fixed coupling for potentiometer 33mm  |
| 27<br>+25    |  | Fixed coupling for potentiometer 13mm  |
| 27<br>+26    |  | Fixed coupling for potentiometer 17mm  |
| 29           |  | Support plate for potentiometer with O-ring  |
| 31<br>+30    |  | Bush for potentiometer   |
| 40           |  | Lateral gear wheel Z 35<br>Lateral gear wheel Z 37<br>Lateral gear wheel Z 36<br>Lateral gear wheel Z 38<br>Lateral gear wheel Z 40            |

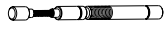
## Parts List

| Reference                | Drawing   | Description              |
|--------------------------|---|--------------------------|
| 40                       |    | Lateral gear wheel Z 42  |
|                          |   | Lateral gear wheel Z 44  |
|                          |   | Lateral gear wheel Z 46  |
|                          |   | Lateral gear wheel Z 48  |
|                          |   | Lateral gear wheel Z 50  |
|                          |   | Lateral gear wheel Z 52  |
|                          |   | Lateral gear wheel Z 54  |
|                          |   | Lateral gear wheel Z 56  |
|                          |   | Lateral gear wheel Z 58  |
|                          |   | Lateral gear wheel Z 60  |
|                          |   | Lateral gear wheel Z 62  |
|                          |   | Lateral gear wheel Z 64  |
|                          |   | Lateral gear wheel Z 66  |
|                          |   | Lateral gear wheel Z 68  |
|                          |   | Lateral gear wheel Z 70  |
|                          |   | Lateral gear wheel Z 72  |
|                          |   | Lateral gear wheel Z 74  |
|                          |   | Lateral gear wheel Z 76  |
|                          |   | Lateral gear wheel Z 78  |
|                          |   | Lateral gear wheel Z 80  |
|                          |   | Lateral gear wheel Z 82  |
|                          |   | Lateral gear wheel Z 84  |
|                          |   | Lateral gear wheel Z 86  |
|                          |   | Lateral gear wheel Z 88  |
|                          |   | Lateral gear wheel Z 90  |
|                          |   | Lateral gear wheel Z 92  |
|                          |   | Lateral gear wheel Z 94  |
| Lateral gear wheel Z 96  |   |                          |
| Lateral gear wheel Z 98  |   |                          |
| Lateral gear wheel Z 100 |   |                          |
| Lateral gear wheel Z 102 |   |                          |
| Lateral gear wheel Z 104 |   |                          |
| Lateral gear wheel Z 106 |   |                          |
| Lateral gear wheel Z 108 |   |                          |
| Lateral gear wheel Z 107 |   |                          |
| Lateral gear wheel Z 109 |   |                          |
| 46<br>+45                |  | Pinion gear M10 Z12      |
|                          |   | Pinion gear M12 Z10      |
|                          |   | Pinion gear M14 Z10      |
|                          |   | Pinion gear M16 Z10      |
|                          |   | Pinion gear M20 Z8       |
|                          |   | Pinion gear M5 Z12       |
|                          |   | Pinion gear M6 Z11       |
|                          |   | Pinion gear M8 Z12       |
| Pinion gear M12 Z12      |   |                          |
| 47<br>+48                |  | Flange                   |
| 49<br>+50                |  | Male coupling            |
| 51<br>+50                |  | Female coupling          |
| 54                       |  | Single-thread worm shaft |
|                          |   | Double-thread worm shaft |
| 54                       |  | Flexible shaft           |
| 56                       |  | Central gear wheel Z 100 |

## Request Form for Non Standard Limit Switches

### Cams

- 1 MY140PI
- 2 MY141PI
- 3 MY142PI
- 4 MY143PI
- 5 MY144PI

### Switches

- 1 MY036XX Snap action
- 2 MY037XX Slow action

### Potentiometers / Encoders

- 1 MY020PE 4.7 kΩ continuous rotation
- 2 MY025PE 10 kΩ continuous rotation
- 3 MY035PE 2.2 kΩ continuous rotation
- 4 MY030PE MCB 10 kΩ
- 5 MY031PE MCB 10 kΩ continuous rotation

### Male coupling



### Female coupling



### Flange

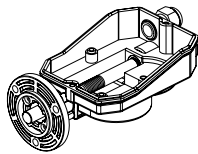

### Potentiometer / Encoder

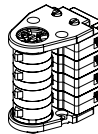
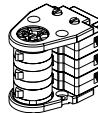
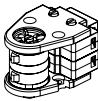

Revolution ratio

|  |                          |                          |                          |                          |  |  |  |  |
|--|--------------------------|--------------------------|--------------------------|--------------------------|--|--|--|--|
|  | <input type="checkbox"/> | <input type="checkbox"/> | <input type="checkbox"/> | <input type="checkbox"/> |  |  |  |  |
|  | <input type="checkbox"/> | <input type="checkbox"/> | <input type="checkbox"/> | <input type="checkbox"/> |  |  |  |  |
|  | <input type="checkbox"/> | <input type="checkbox"/> | <input type="checkbox"/> | <input type="checkbox"/> |  |  |  |  |
|  | <input type="checkbox"/> | <input type="checkbox"/> | <input type="checkbox"/> | <input type="checkbox"/> |  |  |  |  |
|  | <input type="checkbox"/> | <input type="checkbox"/> | <input type="checkbox"/> | <input type="checkbox"/> |  |  |  |  |
|  | <input type="checkbox"/> | <input type="checkbox"/> | <input type="checkbox"/> | <input type="checkbox"/> |  |  |  |  |
|  | <input type="checkbox"/> | <input type="checkbox"/> | <input type="checkbox"/> | <input type="checkbox"/> |  |  |  |  |
|  | <input type="checkbox"/> | <input type="checkbox"/> | <input type="checkbox"/> | <input type="checkbox"/> |  |  |  |  |
|  | <input type="checkbox"/> | <input type="checkbox"/> | <input type="checkbox"/> | <input type="checkbox"/> |  |  |  |  |

### Cover

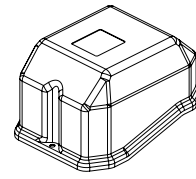

### Standard shaft

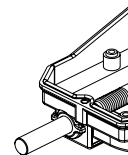

### Flexible shaft

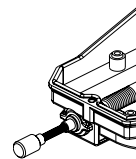

### Pinion gears

- 1 MY911PI M10 Z12
- 2 MY912PI M12 Z10
- 3 MY913PI M14 Z10
- 4 MY914PI M16 Z10
- 5 MY915PI M20 Z8
- 6 MY916PI M5 Z12
- 7 MY917PI M6 Z11
- 8 MY918PI M8 Z12
- 9 MY944PI M12 Z12

### Pinion gear

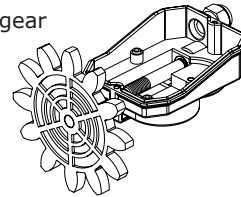

### Instructions

- Mark the boxes corresponding to the components required.
- Write the numbers corresponding to the **cams**, the **switches**, the **pinion gear** and the **potentiometers** required.
- When a potentiometer is required, mark the box corresponding to the type of **coupling** needed.
- Write the **revolution ratio** required for each output.

### Remarks

---

---

---

---

---

---

---

---

---

---

## Use and Maintenance Instructions

*The RLS4C rotary limit switch is an electromechanical device for low voltage control circuits (EN 60947-1, EN 60947-5-1) to be used as electrical equipment on machines (EN 60204-1) in compliance with the fundamental requirements of the Low Voltage Directive 73/23/CEE and of the Machine Directive 89/392/CEE.*

The limit switch is designed for industrial use and also for use under particularly severe climatic conditions (operational temperature from  $-25^{\circ}\text{C}$  to  $+70^{\circ}\text{C}$ , suitable for use in tropical environment). The equipment is not suitable for use in environments with potentially explosive atmosphere, corrosive agents or a high percentage of sodium chloride (saline fog). Oils, acids or solvents may damage the equipment. Use the fixing holes on the base or the flange (47) to mount the limit switch. The use of special couplings (49, 51), flexible shafts or special driving systems (not supplied) are recommended for eliminating any misalignment between the limit switch shaft (54, 61) and the reduction gear shaft to which it is connected. After loosening the central screw (03) use the screws (09, 10, 12, 13) to adjust the operating point of the cams (08); once the cams are adjusted, tighten the central screw (03).

The switches (07) are designed for auxiliary control of contactors or electromagnetic loads (utilisation category AC-15 according to EN 60947-5-1). The switches (07) have positive opening operation contacts (EN 60947-5-1). Do not connect more than one phase to each switch (07). Do not oil or grease the control elements (08) or the switches (07). For easy wiring, the set of cams/switches (35) may be removed by loosening the screws (15) on the lower fixing plate; do not loosen the screws (01) on the upper part of the set of cams/switches in order not to take apart the switches; after wiring is completed, the set of cams/switches (35) must be properly fixed and screwed, paying attention to the coupling of the hexagonal plastic bushes (14, 38).

The installation of the limit switch shall be carried out by an expert and trained personnel. Wiring shall be properly done according to the current instructions.

Prior to the installation and the maintenance of the limit switch, the main power of the machinery shall be turned off.

### Steps for the proper installation of the limit switch

- loosen the fixing screw (32) and remove the cover (33)
- connect the limit switch shaft (54, 61) to the reduction gear shaft; to avoid any misalignment between the two shafts the use of couplings (49, 51), flexible shafts or special driving systems is recommended
- fix the limit switch firmly in place to prevent abnormal vibrations of the equipment during operation; use only the fixing holes on the base or the flange (47) to fix the equipment
- insert the cable into the limit switch through the cable clamp (41)
- strip the cable to a length suitable for wiring the switches (07)
- tape the stripped part of the cable
- clamp the wire into the cable clamp (41)
- connect all the switches (07) according to the contact scheme printed on the switches (tighten the wires into the terminals with a torque equal to 0.8 Nm; insertability of wires into the switch terminals equal to  $2 \times 1.5 \text{ mm}^2 - 1 \times 2.5 \text{ mm}^2$ )
- adjust the operating point of the cams (08); for proper adjustment, loosen the central screw (03) of the cam set, adjust the operating point of each single cam (08) by turning its screw (09, 10, 12, 13) (the numbers on the screws refer to the cams counting from bottom to top), then tighten the central screw (03)
- close the limit switch checking the proper positioning of the rubber (34) in the cover (33)

### Periodic maintenance steps

- check the proper tightening of the screws (32) and cover (33)
- check the proper tightening of the switch (07) terminal screws
- check the proper tightening of the central screw (03) holding the cams (08)
- check the wiring conditions (in particular where wires clamp into the switch)
- check the proper positioning of the front (52) and rear (42) bush covers
- check the conditions of the rubber (34) fit into the cover (33) and check the tightening of the cable clamp (41) around the cable
- check that the limit switch enclosure (33, 43, 44) is not broken
- check the alignment between the limit switch shaft (54, 61) and the reduction gear shaft
- check that the limit switch is properly fixed

In case any component of the limit switch is modified, the validity of the markings and the guarantee on the equipment are annulled. Should any component need replacement, use original spare parts only.

MEYLE declines all responsibility for damages caused by the improper use or installation of the equipment.