

**SEMIPACK® 3**

## Rectifier Diode Modules

### SKKE 380

#### Features

- Heat transfer through aluminium nitride ceramic isolated metal baseplate
- Precise metal pressure contacts for high reliability
- UL recognized, file no. E 63 53

#### Typical Applications\*

- Line rectifiers for transistorized AC motor controllers
- Field supply for DC motors

1) The screws must be lubricated

$V_{RSM}$ V	$V_{RRM}$ V	$I_{FRMS} = 600$ A (maximum value for continuous operation) $I_{FAV} = 380$ A (sin. 180; $T_c = 100$ °C)	
1300	1200	SKKE 380/12	
1700	1600	SKKE 380/16	

Symbol	Conditions	Values	Units
$I_{FAV}$	sin. 180; $T_c = 100$ °C	380	A
$I_{FSM}$	$T_{vj} = 25$ °C; 10 ms	11000	A
	$T_{vj} = 150$ °C; 10 ms	10000	A
$i^2t$	$T_{vj} = 25$ °C; 8,3 ... 10 ms	605000	A <sup>2</sup> s
	$T_{vj} = 150$ °C; 8,3 ... 10 ms	500000	A <sup>2</sup> s
$V_F$	$T_{vj} = 25$ °C; $I_F = 1000$ A	max. 1,25	V
$V_{(TO)}$	$T_{vj} = 150$ °C	max. 0,8	V
$r_T$	$T_{vj} = 150$ °C	max. 0,35	mΩ
$I_{RD}$	$T_{vj} = 150$ °C; $V_{RD} = V_{RRM}$	max. 10	mA
$R_{th(j-c)}$	cont.; per diode = per module	0,11	K/W
	sin. 180; per diode = per module	0,116	K/W
$R_{th(c-s)}$	per diode = per module	0,04	K/W
$T_{vj}$		- 40 ... + 150	°C
$T_{stg}$		- 40 ... + 130	°C
$V_{isol}$	a. c. 50 Hz; r.m.s.; 1 s / 1 min.	3600 / 3000	V~
$M_s$	to heatsink	$5 \pm 15$ %	Nm
$M_t$	to terminals	$9 \pm 15$ % <sup>1)</sup>	Nm
$a$		$5 * 9,81$	m/s <sup>2</sup>
$m$	approx.	550	g
Case		A 77b	

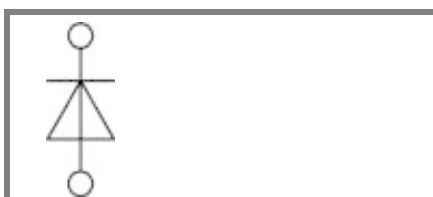

**SKKE**

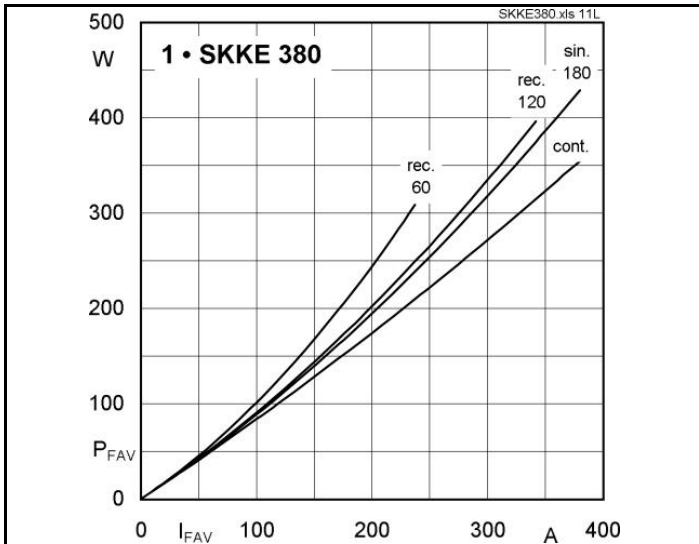

Fig. 11L Power dissipation per diode vs. forward current

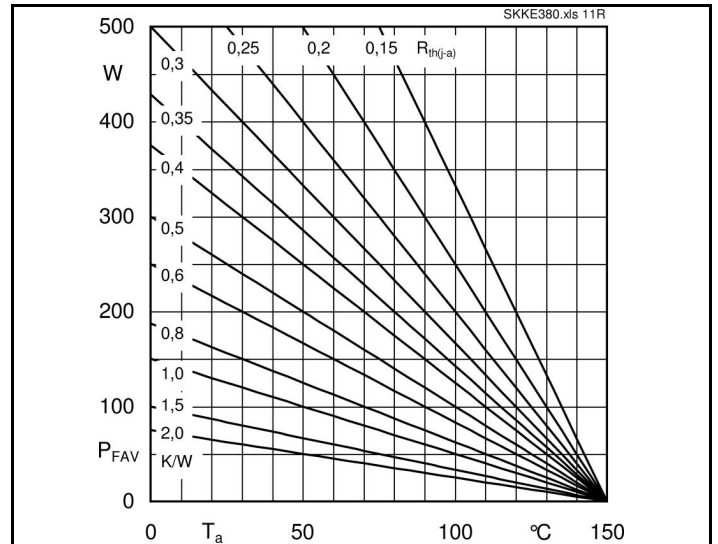

Fig. 11R Power dissipation per diode vs. ambient temperature

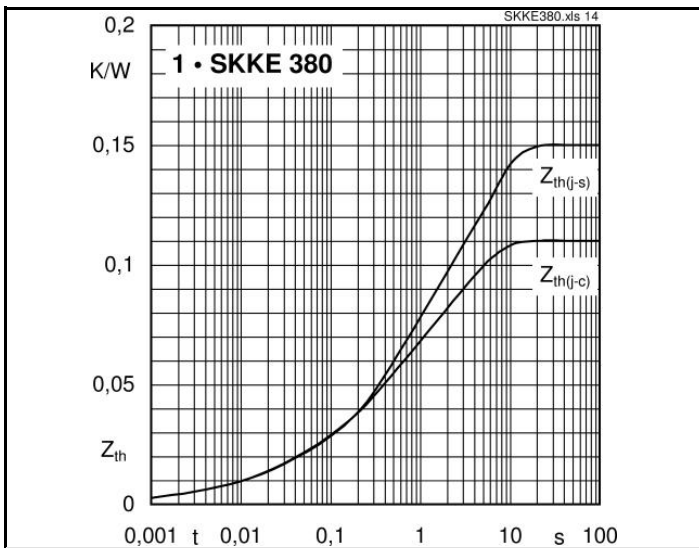

Fig. 14 Transient thermal impedance vs. time

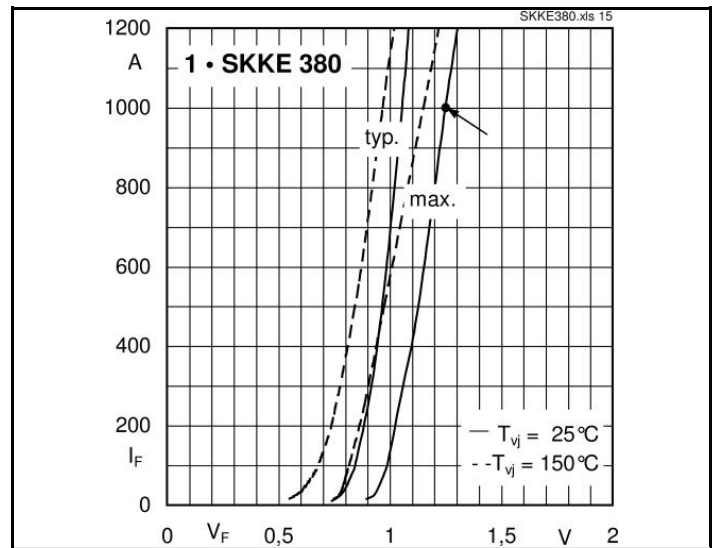

Fig. 15 Forward characteristics

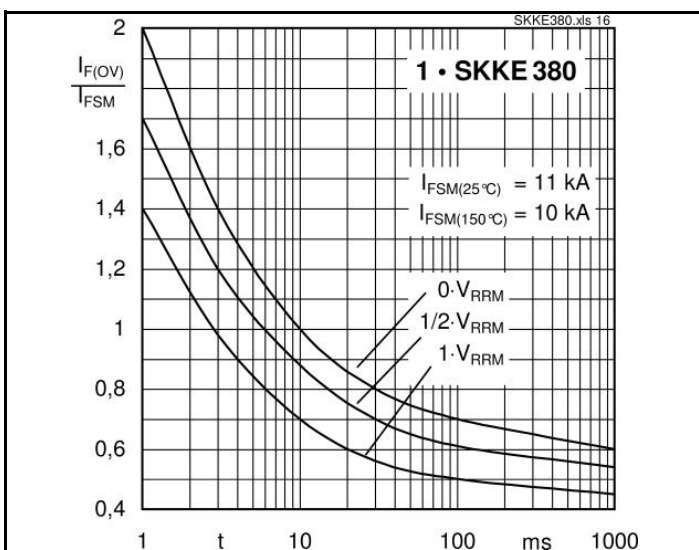
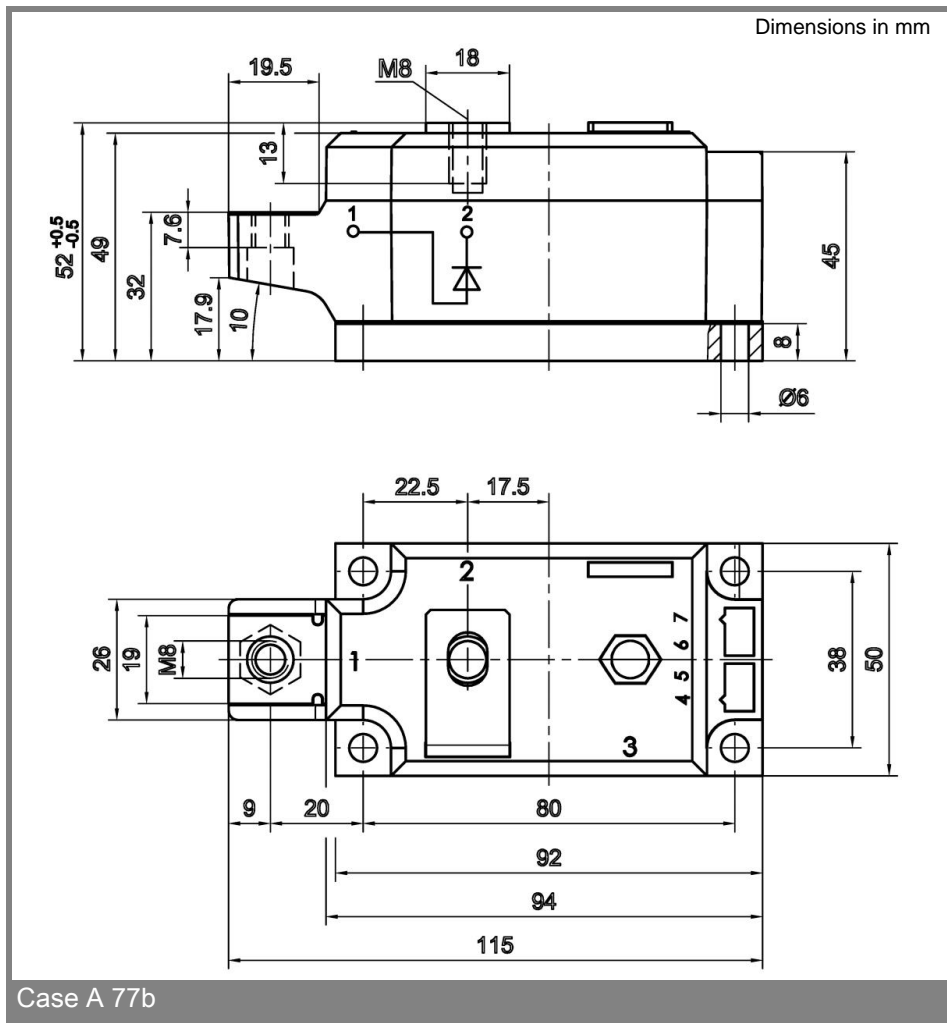

Fig. 16 Surge overload current vs. time



\* The specifications of our components may not be considered as an assurance of component characteristics. Components have to be tested for the respective application. Adjustments may be necessary. The use of SEMIKRON products in life support appliances and systems is subject to prior specification and written approval by SEMIKRON. We therefore strongly recommend prior consultation of our personal.