

**WILDEN**<sup>®</sup>  
Part of Pump Solutions Group  
A **DOVER** COMPANY

**EOM**  
Engineering  
Operation &  
Maintenance

**PS8**  
Original™ Series  
Metal Pump

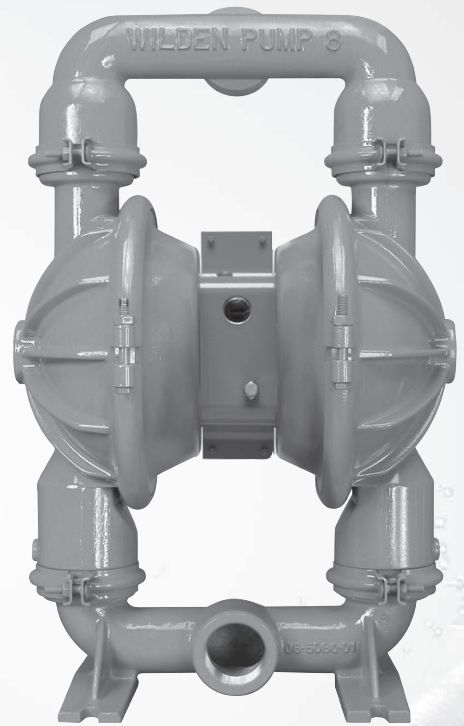

*Where Innovation Flows*

[www.wildenpump.com](http://www.wildenpump.com)

**PRO-FLO**  
//SHIFT  
PROGRESSIVE PUMP TECHNOLOGY



WIL-10410-E-02  
TO REPLACE WIL-10410-E-01

**TABLE OF CONTENTS**

**SECTION 1 CAUTIONS—READ FIRST! ..... 1**

**SECTION 2 WILDEN PUMP DESIGNATION SYSTEM ..... 2**

**SECTION 3 HOW IT WORKS—PUMP & AIR DISTRIBUTION SYSTEM ..... 3**

**SECTION 4 DIMENSIONAL DRAWINGS ..... 4**

**SECTION 5 PERFORMANCE**

    PS8 Rubber-Fitted ..... 5

    PS8 EZ-Install TPE-Fitted ..... 5

    PS8 Full-Stroke PTFE-Fitted ..... 6

    Suction-Lift Curves ..... 7

**SECTION 6 SUGGESTED INSTALLATION, OPERATION & TROUBLESHOOTING ..... 8**

**SECTION 7 ASSEMBLY / DISASSEMBLY ..... 11**

    Air Valve / Center Section Disassembly ..... 14

    Reassembly Hints & Tips ..... 18







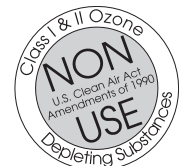







**SECTION 8 EXPLODED VIEW & PARTS LISTING**

    PS8 Metal ..... 20

**SECTION 9 ELASTOMER OPTIONS ..... 22**



## CAUTIONS—READ FIRST!

-  **CAUTION:** Do not apply compressed air to the exhaust port — pump will not function.
-  **CAUTION:** Do not over-lubricate air supply — excess lubrication will reduce pump performance. Pump is pre-lubed.
-  **TEMPERATURE LIMITS:**
- |   |                |                |
|---|----------------|----------------|
| Polypropylene                               | 0°C to 79°C    | 32°F to 175°F  |
| PVDF  | -12°C to 107°C | 10°F to 225°F  |
| PFA   | 7°C to 107°C   | 20°F to 225°F  |
| Neoprene                                    | -18°C to 93°C  | 0°F to 200°F   |
| Buna-N                                      | -12°C to 82°C  | 10°F to 180°F  |
| EPDM  | -51°C to 138°C | -60°F to 280°F |
| Viton® FKM                                  | -40°C to 177°C | -40°F to 350°F |
| Wil-Flex™                                   | -40°C to 107°C | -40°F to 225°F |
| Saniflex™                                   | -29°C to 104°C | -20°F to 220°F |
| Polyurethane                                | -12°C to 66°C  | 10°F to 150°F  |
| Polytetrafluoroethylene (PTFE) <sup>1</sup> | 4°C to 104°C   | 40°F to 220°F  |
| Nylon                                       | -18°C to 93°C  | 0°F to 200°F   |
| Acetal                                      | -29°C to 82°C  | -20°F to 180°F |
| SIPD PTFE with Neoprene-backed              | 4°C to 104°C   | 40°F to 220°F  |
| SIPD PTFE with EPDM-backed                  | -10°C to 137°C | 14°F to 280°F  |
| Polyethylene                                | 0°C to 70°C    | 32°F to 158°F  |
| Geolast®                                    | -40°C to 82°C  | -40°F to 180°F |
- <sup>1</sup>4°C to 149°C (40°F to 300°F) - 13 mm (1/2") and 25 mm (1") models only.
-  **CAUTION:** When choosing pump materials, be sure to check the temperature limits for all wetted components. Example: Viton® has a maximum limit of 177°C (350°F) but polypropylene has a maximum limit of only 79°C (175°F).
-  **CAUTION:** Maximum temperature limits are based upon mechanical stress only. Certain chemicals will significantly reduce maximum safe operating temperatures. Consult Chemical Resistance Guide (E4) for chemical compatibility and temperature limits.
-  **WARNING:** Prevent static sparking — If static sparking occurs, fire or explosion could result. Pump, valves and containers must be grounded to a proper grounding point when handling flammable fluids and whenever discharge of static electricity is a hazard.
-  **CAUTION:** Do not exceed 8.6 bar (125 psig) air supply pressure.
-  **CAUTION:** The process fluid and cleaning fluids must be chemically compatible with all wetted pump components (see E4).
-  **CAUTION:** Do not exceed 82°C (180°F) air inlet temperature for Pro-Flo® SHIFT models.
-  **CAUTION:** Pumps should be thoroughly flushed before installing into process lines. FDA- and USDA-approved pumps should be cleaned and/or sanitized before being used.
-  **CAUTION:** Always wear safety glasses when operating pump. If diaphragm rupture occurs, material being pumped may be forced out air exhaust.
-  **CAUTION:** Before any maintenance or repair is attempted, the compressed air line to the pump should be disconnected and all air pressure allowed to bleed from pump. Disconnect all intake, discharge and air lines. Drain the pump by turning it upside down and allowing any fluid to flow into a suitable container.
-  **CAUTION:** Blow out air line for 10 to 20 seconds before attaching to pump to make sure all pipeline debris is clear. Use an in-line air filter. A 5µ (micron) air filter is recommended.
-  **NOTE:** When installing PTFE diaphragms, it is important to tighten outer pistons simultaneously (turning in opposite directions) to ensure tight fit. (See torque specifications in Section 7.)
-  **NOTE:** Cast Iron PTFE-fitted pumps come standard from the factory with expanded PTFE gaskets installed in the diaphragm bead of the liquid chamber. PTFE gaskets cannot be reused. Consult PS-TG for installation instructions during reassembly.
-  **NOTE:** Before starting disassembly, mark a line from each liquid chamber to its corresponding air chamber. This line will assist in proper alignment during reassembly.
-  **CAUTION:** Pro-Flo® pumps cannot be used in submersible applications. Pro-Flo® SHIFT pumps do have a single-point exhaust option for submersible applications. Do not use standard Pro-Flo® SHIFT models in submersible applications. Pro-Flo X™ and Turbo-Flo® pumps are also available in a single-point exhaust (submersible) configuration.
-  **CAUTION:** Tighten all hardware prior to installation.



**WILDEN PUMP DESIGNATION SYSTEM**

**PS8 METAL**

**51 mm (2") Pump  
Maximum Flow Rate:  
723 lpm (191 gpm)**

**LEGEND**

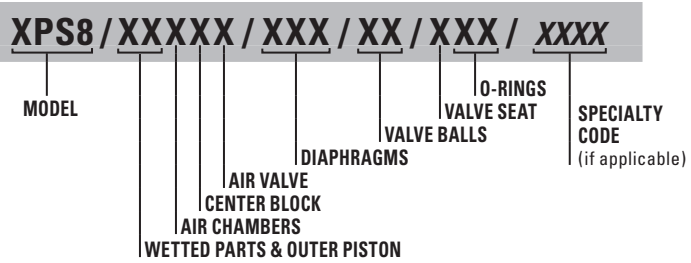

**MATERIAL CODES**

**MODEL**

XPS8 = PRO-FLO® SHIFT ATEX

**WETTED PARTS/OUTER PISTON**

AA = ALUMINUM / ALUMINUM  
SS = STAINLESS STEEL / STAINLESS STEEL  
WW = CAST IRON / CAST IRON

**AIR CHAMBERS**

A = ALUMINUM  
N = NICKEL-PLATED  
S = STAINLESS STEEL

**CENTER BLOCK**

A = ALUMINUM  
N = NICKEL-PLATED

**AIR VALVE**

A = ALUMINUM  
N = NICKEL-PLATED  
R = ANODIZED ALUMINUM

**DIAPHRAGMS**

BNS = BUNA-N (Red Dot)  
EPS = EPDM (Blue Dot)  
FWS = SANITARY WIL-FLEX™, EZ-INSTALL [SANTOPRENE® (Two Colored Dots)]  
NES = NEOPRENE (Green Dot)  
TSS = FULL STROKE PTFE W/SANIFLEX™ BACK-UP  
TWS = FULL STROKE PTFE W/WIL-FLEX™ BACK-UP  
XBS = CONDUCTIVE BUNA-N (Two Red Dots)  
ZGS = GEOLAST®, EZ-INSTALL  
ZPS = POLYURETHANE, EZ-INSTALL  
ZSS = SANIFLEX™, EZ-INSTALL  
ZWS = WIL-FLEX™, EZ-INSTALL  
VTS = VITON®

**VALVE BALLS**

BN = BUNA-N (Red Dot)  
FS = SANIFLEX™ [Hytre® (Cream)]  
FW = SANITARY WIL-FLEX™ [Santoprene® (Two Orange Dots)]  
EP = EPDM (Blue Dot)  
NE = NEOPRENE (Green Dot)  
PU = POLYURETHANE (Brown)  
TF = PTFE (White)  
VT = VITON® (Silver or White Dot)

**VALVE SEAT**

A = ALUMINUM  
BN = BUNA-N (Red Dot)  
EP = EPDM (Blue Dot)  
FS = SANIFLEX™ [Hytre® (Cream)]  
FW = SANITARY WIL-FLEX™ [Santoprene® (Two Orange Dots)]  
M = MILD STEEL  
NE = NEOPRENE (Green Dot)  
PU = POLYURETHANE (Brown)  
S = STAINLESS STEEL  
VT = VITON® (White Dot)

**VALVE SEAT O-RING**

TF = PTFE

**SPECIALTY CODES**

- |  |  |   |
|--|--|---|
| 0014 BSP                                 | 0070 Saniflo™ FDA                                | 0108 Wil-Gard 220V, BSP   |
| 0023 Wing nuts                           | 0075 Saniflo™ FDA, Stallion balls and seats ONLY | 0118 Stallion balls and seats ONLY, BSP                                   |
| 0030 Screen based                        | 0079 Tri-clamp fittings, wing nuts               | 0120 Saniflo™ FDA, Wil-Gard 110V  |
| 0036 Screen based, BSP                   | 0080 Tri-clamp fittings ONLY                     | 0320 Single-Point Exhaust center block                                    |
| 0039 Screen based, polyurethane screen   | 0100 Wil-Gard 110V                               | 0324 Single-Point Exhaust center block, screen base                       |
| 0044 Stallion, balls & seats ONLY        | 0102 Wil-Gard, sensor wires ONLY                 | 0327 Single-Point Exhaust center block, Stallion externals, balls & seats |
| 0047 Stallion externals, balls and seats | 0103 Wil-Gard 220V                               | 0330 Wing nuts, BSP   |
|  |  | 0480 Pump Cycle Monitor (Sensor & Wires)                                  |

NOTE: Most elastomeric materials use colored dots for identification.  
NOTE: Not all models are available with all material options.

Viton® is a registered trademark of DuPont Dow Elastomers.



**HOW IT WORKS—PUMP**

The Wilden diaphragm pump is an air-operated, positive displacement, self-priming pump. These drawings show flow pattern through the pump upon its initial stroke. It is assumed the pump has no fluid in it prior to its initial stroke.

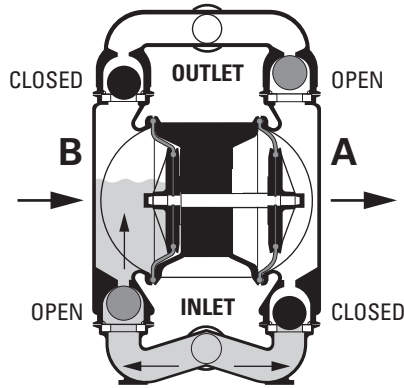

**FIGURE 1** The air valve directs pressurized air to the back side of diaphragm A. The compressed air is applied directly to the liquid column separated by elastomeric diaphragms. The diaphragm acts as a separation membrane between the compressed air and liquid, balancing the load and removing mechanical stress from the diaphragm. The compressed air moves the diaphragm away from the center of the pump. The opposite diaphragm is pulled in by the shaft connected to the pressurized diaphragm. Diaphragm B is on its suction stroke; air behind the diaphragm has been forced out to atmosphere through the exhaust port of the pump. The movement of diaphragm B toward the center of the pump creates a vacuum within chamber B. Atmospheric pressure forces fluid into the inlet manifold forcing the inlet valve ball off its seat. Liquid is free to move past the inlet valve ball and fill the liquid chamber (see shaded area).

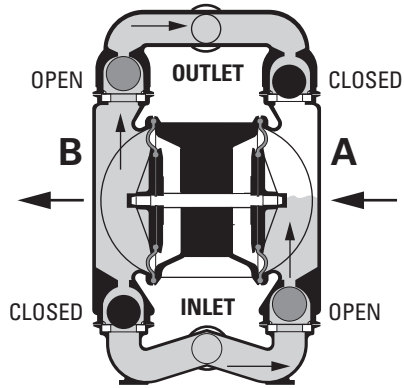

**FIGURE 2** When the pressurized diaphragm, diaphragm A, reaches the limit of its discharge stroke, the air valve redirects pressurized air to the back side of diaphragm B. The pressurized air forces diaphragm B away from the center while pulling diaphragm A to the center. Diaphragm B is now on its suction stroke. Diaphragm B forces the inlet valve ball onto its seat due to the hydraulic forces developed in the liquid chamber and manifold of the pump. These same hydraulic forces lift the discharge valve ball off its seat, while the opposite discharge valve ball is forced onto its seat, forcing fluid to flow through the pump discharge. The movement of diaphragm A toward the center of the pump creates a vacuum within liquid chamber A. Atmospheric pressure forces fluid into the inlet manifold of the pump. The inlet valve ball is forced off its seat allowing the fluid being pumped to fill the liquid chamber.

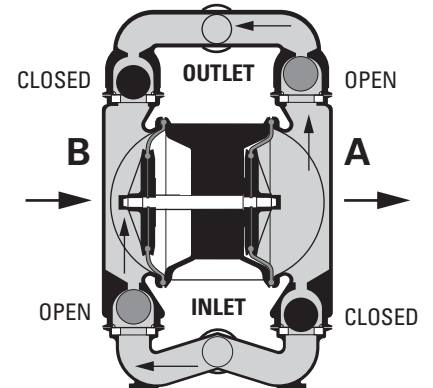

**FIGURE 3** At completion of the stroke, the air valve again redirects air to the back side of diaphragm A, which starts diaphragm B on its exhaust stroke. As the pump reaches its original starting point, each diaphragm has gone through one exhaust and one discharge stroke. This constitutes one complete pumping cycle. The pump may take several cycles to completely prime depending on the conditions of the application.



**HOW IT WORKS—AIR DISTRIBUTION SYSTEM**

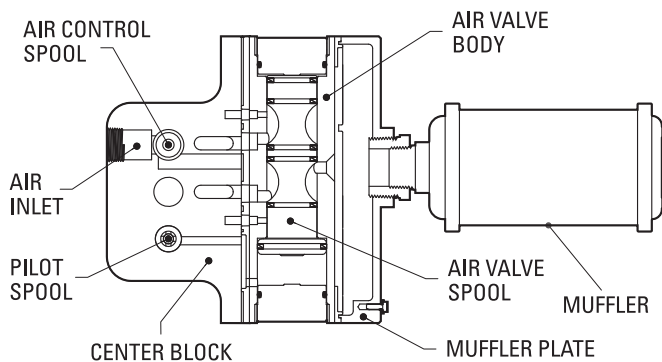

The heart of the patented Pro-Flo® SHIFT Air Distribution System (ADS) is the air valve assembly. The air valve design incorporates an unbalanced spool with the small end of the spool being pressurized continuously while the large end of the spool is alternately pressurized, then exhausted to move the spool. The air valve spool directs pressurized air to one chamber while exhausting the other. The air forces the main shaft/diaphragm assembly to move to one side – discharging liquid on that side and pulling liquid in on the other side. When the shaft reaches the end of the stroke, the inner piston actuates the pilot spool, which controls the air to the large end of the air valve spool. The repositioning of the air valve spool routes the air to the other air chamber. The air control spool allows air to flow freely into the air chamber for the majority of each pump stroke, but it significantly restricts the flow of air into the air chamber when activated by the inner piston near the end of the each stroke.



**DIMENSIONAL DRAWINGS**

**PS8 Metal**

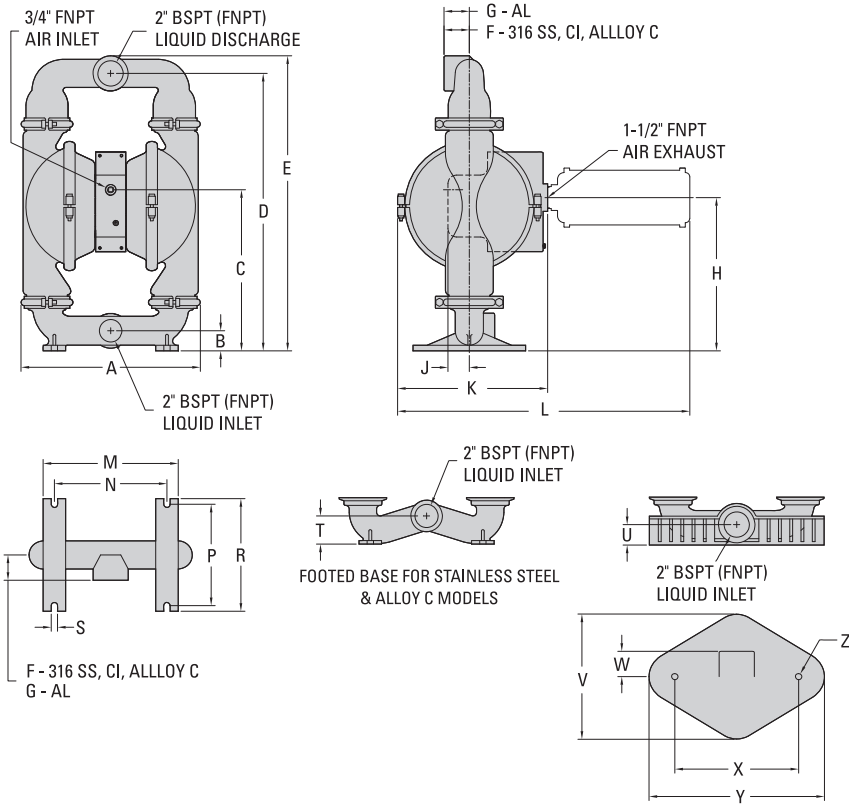

**DIMENSIONS**

ITEM	METRIC (mm)	STANDARD (inch)
A	404	15.9
B	45	1.8
C	363	14.3
D	630	24.8
E	668	26.3
F	58	2.3
G	64	2.5
H	346	13.6
J	48	1.9
K	339	13.3
L	659	26
M	315	12.4
N	257	10.1
P	231	9.1
R	257	10.1
S	15	0.6
T	64	2.5
U	51	2.0
V	284	11.2
W	58	2.3
X	279	11
Y	396	15.6
Z	15 DIA.	0.6 DIA.

LW0022 REV. A

**PS8 Metal Saniflo™**

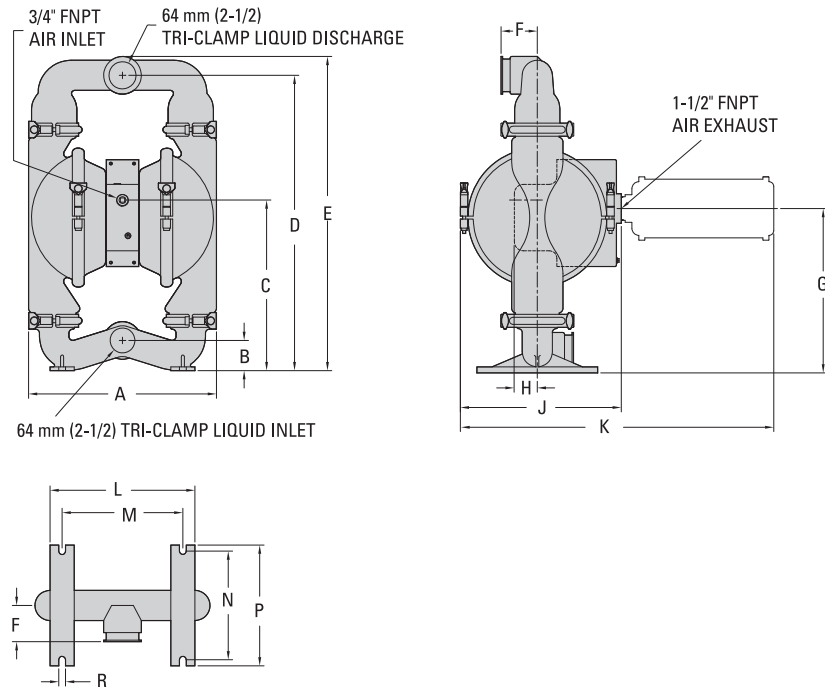

**DIMENSIONS**

ITEM	METRIC (mm)	STANDARD (inch)
A	409	16.1
B	64	2.5
C	359	14.1
D	625	24.6
E	665	26.2
F	76	3.0
G	346	13.6
H	48	1.9
J	339	13.3
K	659	26
L	305	12
M	254	10
N	229	9.0
P	254	10
R	15 DIA.	0.6 DIA.

LW0023 REV. A



**PERFORMANCE**

**PS8 METAL RUBBER-FITTED**

Height ..... 668 mm (26.3")  
 Width ..... 404 mm (15.9")  
 Depth ..... 338 mm (13.3")  
 Ship Weight ..... Aluminum 35 kg (78 lbs)  
                           316 Stainless Steel 53 kg (117 lbs)  
                           Cast Iron 49 kg (109 lbs)  
                           Alloy C 54 kg (119 lbs)  
 Air Inlet ..... 19 mm (3/4")  
 Inlet ..... 51 mm (2")  
 Outlet ..... 51 mm (2")  
 Suction Lift ..... 7.2 m Dry (23.8')  
                           9.0 m Wet (29.5')  
 Disp. per Stroke ..... 2.6 L (0.69 gal)<sup>1</sup>  
 Max. Flow Rate ..... 700 lpm (185 gpm)  
 Max. Size Solids ..... 6.4 mm (1/4")

<sup>1</sup>Displacement per stroke was calculated at 4.8 bar (70 psig) air inlet pressure against a 2.1 bar (30 psig) head pressure.

**Example:** To pump 329 lpm (87 gpm) against a discharge head of 2.1 bar (30 psig) requires 4.1 bar (60 psig) and 75 Nm<sup>3</sup>/h (44 scfm) air consumption.

**Caution:** Do not exceed 8.6 bar (125 psig) air supply pressure.

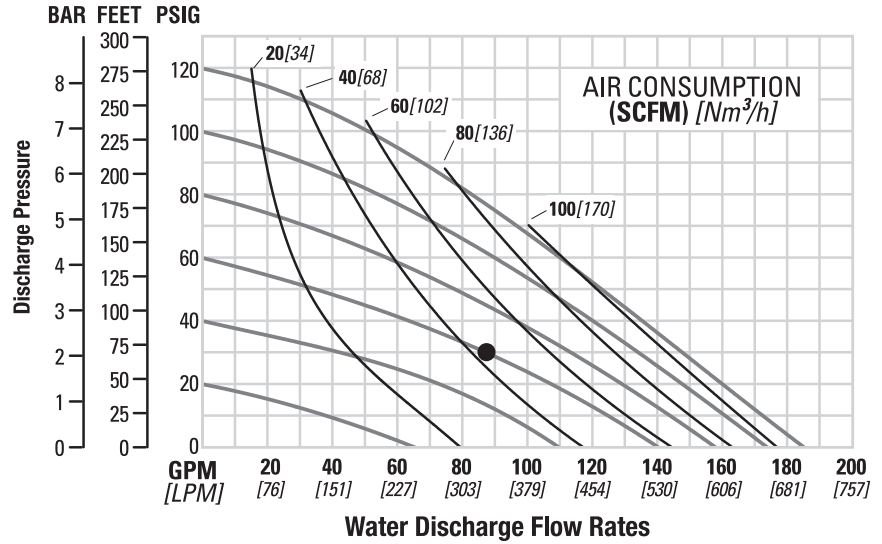

Flow rates indicated on chart were determined by pumping water.

For optimum life and performance, pumps should be specified so that daily operation parameters will fall in the center of the pump's performance curve.

**PS8 METAL EZ-INSTALL TPE-FITTED**

Height ..... 668 mm (26.3")  
 Width ..... 404 mm (15.9")  
 Depth ..... 338 mm (13.3")  
 Ship Weight ..... Aluminum 35 kg (78 lbs)  
                           316 Stainless Steel 53 kg (117 lbs)  
                           Cast Iron 49 kg (109 lbs)  
                           Alloy C 54 kg (119 lbs)  
 Air Inlet ..... 19 mm (3/4")  
 Inlet ..... 51 mm (2")  
 Outlet ..... 51 mm (2")  
 Suction Lift ..... 6.9 m Dry (22.7')  
                           9.0 m Wet (29.5')  
 Disp. per Stroke ..... 2.6 L (0.69 gal)<sup>1</sup>  
 Max. Flow Rate ..... 719 lpm (190 gpm)  
 Max. Size Solids ..... 6.4 mm (1/4")

<sup>1</sup>Displacement per stroke was calculated at 4.8 bar (70 psig) air inlet pressure against a 2.1 bar (30 psig) head pressure.

**Example:** To pump 363 lpm (96 gpm) against a discharge head of 2.8 bar (40 psig) requires 5.5 bar (80 psig) and 102 Nm<sup>3</sup>/h (60 scfm) air consumption.

**Caution:** Do not exceed 8.6 bar (125 psig) air supply pressure.

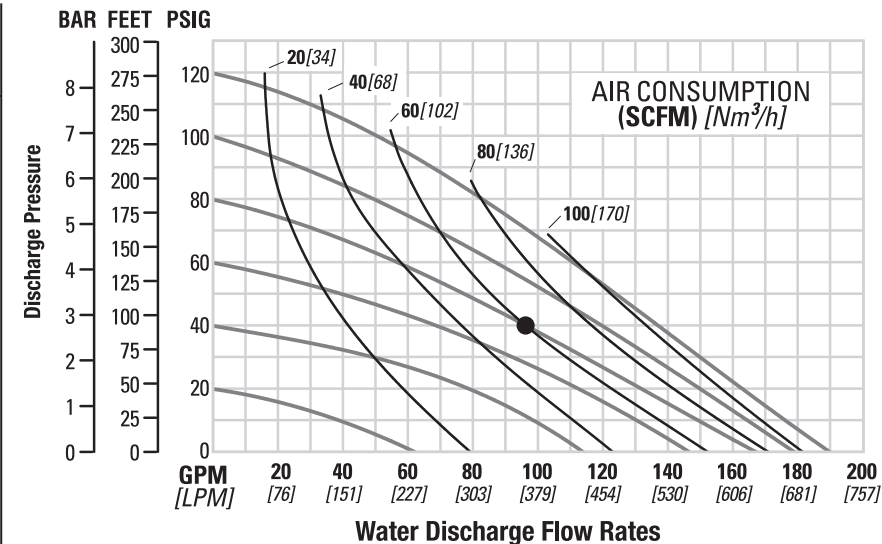

Flow rates indicated on chart were determined by pumping water.

For optimum life and performance, pumps should be specified so that daily operation parameters will fall in the center of the pump's performance curve.

**PS8 METAL  
FULL-STROKE PTFE-FITTED**

Height .....668 mm (26.3")  
 Width .....404 mm (15.9")  
 Depth .....338 mm (13.3")  
 Ship Weight.....Aluminum 35 kg (78 lbs)  
                           316 Stainless Steel 53 kg (117 lbs)  
                           Cast Iron 49 kg (109 lbs)  
                           Alloy C 54 kg (119 lbs)  
 Air Inlet .....19 mm (3/4")  
 Inlet .....51 mm (2")  
 Outlet .....51 mm (2")  
 Suction Lift .....6.3 m Dry (20.7")  
                           8.6 m Wet (28.4')  
 Disp. per Stroke .....2.4 L (0.64 gal)<sup>1</sup>  
 Max. Flow Rate .....723 lpm (191 gpm)  
 Max. Size Solids.....6.4 mm (1/4")

<sup>1</sup>Displacement per stroke was calculated at 4.8 bar (70 psig) air inlet pressure against a 2.1 bar (30 psig) head pressure.

**Example:** To pump 341 lpm (90 gpm) against a discharge head of 2.8 bar (40 psig) requires 5.5 bar (80 psig) and 104 Nm<sup>3</sup>/h (61 scfm) air consumption.

**Caution: Do not exceed 8.6 bar (125 psig) air supply pressure.**

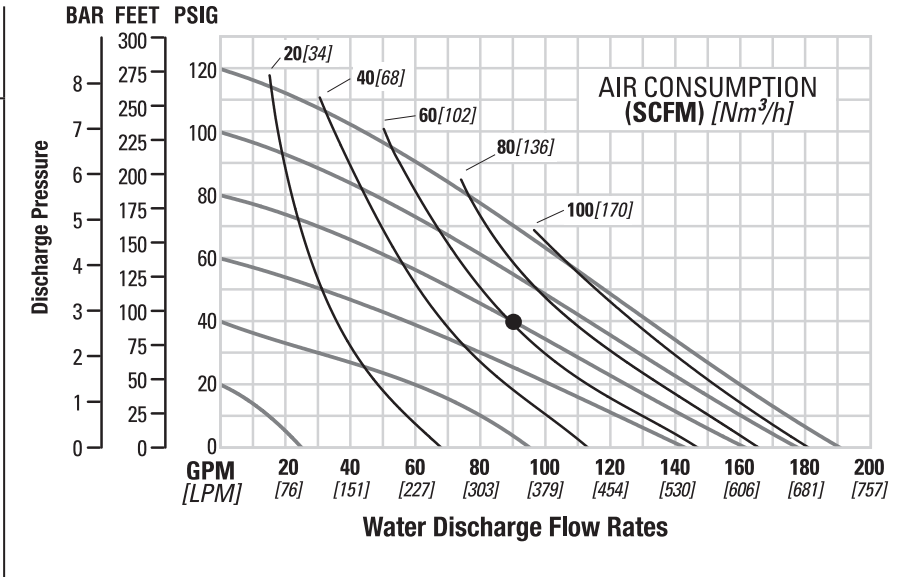

*Flow rates indicated on chart were determined by pumping water.*

*For optimum life and performance, pumps should be specified so that daily operation parameters will fall in the center of the pump's performance curve.*



## SUCTION-LIFT CURVES

### PS8 METAL SUCTION-LIFT CAPABILITY

Suction-lift curves are calibrated for pumps operating at 305 m (1,000') above sea level. This chart is meant to be a guide only. There are many variables that can affect your pump's operating characteristics. The number of intake and discharge elbows, viscosity of pumping fluid, elevation (atmospheric pressure) and pipe friction loss all affect the amount of suction lift your pump will attain.

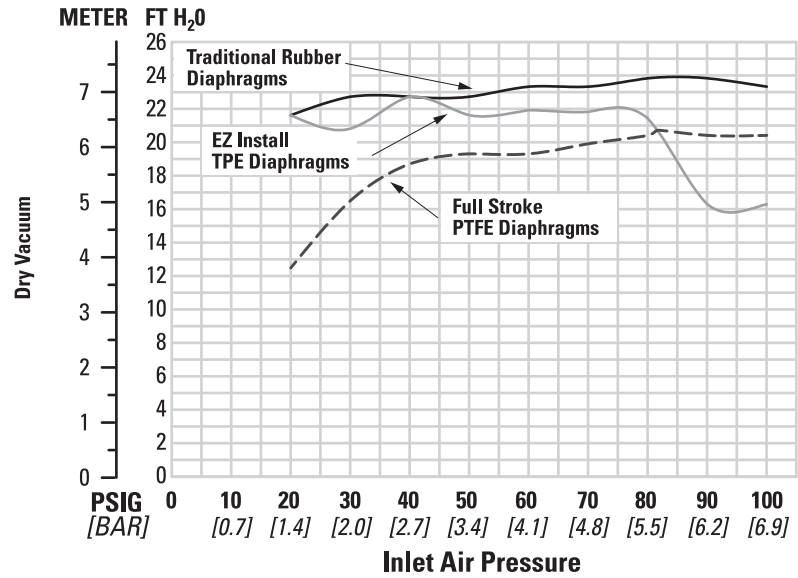



## SUGGESTED INSTALLATION

Wilden pumps are designed to meet the performance requirements of even the most demanding pumping applications. They have been designed and manufactured to the highest standards and are available in a variety of liquid path materials to meet your chemical resistance needs. Refer to the performance section of this manual for an in-depth analysis of the performance characteristics of your pump. Wilden offers the widest variety of elastomer options in the industry to satisfy temperature, chemical compatibility, abrasion resistance and flex concerns.

The suction pipe size should be at least the equivalent or larger than the diameter size of the suction inlet on your Wilden pump. The suction hose must be non-collapsible, reinforced type as these pumps are capable of pulling a high vacuum. Discharge piping should also be the equivalent or larger than the diameter of the pump discharge which will help reduce friction losses. It is critical that all fittings and connections are airtight or a reduction or loss of pump suction capability will result.

**INSTALLATION:** Months of careful planning, study and selection efforts can result in unsatisfactory pump performance if installation details are left to chance.

Premature failure and long-term dissatisfaction can be avoided if reasonable care is exercised throughout the installation process.

**LOCATION:** Noise, safety and other logistical factors usually dictate where equipment will be situated on the production floor. Multiple installations with conflicting requirements can result in congestion of utility areas, leaving few choices for additional pumps.

Within the framework of these and other existing conditions, every pump should be located in such a way that six key factors are balanced against each other to maximum advantage.

**ACCESS:** First of all, the location should be accessible. If it's easy to reach the pump, maintenance personnel will have an easier time carrying out routine inspections and adjustments. Should major repairs become necessary, ease of access can play a key role in speeding the repair process and reducing total downtime.

**AIR SUPPLY:** Every pump location should have an air line large enough to supply the volume of air necessary to achieve the desired pumping rate. Use air pressure up to a maximum of 8.6 bar (125 psig) depending on pumping requirements.

For best results, the pumps should use a 5 $\mu$  (micron) air filter, needle valve and regulator. The use of an air filter before the pump will ensure that the majority of any pipeline contaminants will be eliminated.

**SOLENOID OPERATION:** When operation is controlled by a solenoid valve in the air line, three-way valves should be used. This valve allows trapped air between the valve and the pump to bleed off which improves pump performance. Pumping volume can be estimated by counting the number of strokes per minute and then multiplying the figure by the displacement per stroke.

**MUFFLER:** Sound levels are reduced below OSHA

specifications using the standard Wilden muffler. Other mufflers can be used to further reduce sound levels, but they usually reduce pump performance.

**ELEVATION:** Selecting a site that is well within the pump's dynamic lift capability will assure that loss-of-prime issues will be eliminated. In addition, pump efficiency can be adversely affected if proper attention is not given to site location.

**PIPING:** Final determination of the pump site should not be made until the piping challenges of each possible location have been evaluated. The impact of current and future installations should be considered ahead of time to make sure that inadvertent restrictions are not created for any remaining sites.

The best choice possible will be a site involving the shortest and straightest hook-up of suction and discharge piping. Unnecessary elbows, bends and fittings should be avoided. Pipe sizes should be selected to keep friction losses within practical limits. All piping should be supported independently of the pump. In addition, the piping should be aligned to avoid placing stress on the pump fittings.

Flexible hose can be installed to aid in absorbing the forces created by the natural reciprocating action of the pump. If the pump is to be bolted down to a solid location, a mounting pad placed between the pump and the foundation will assist in minimizing pump vibration. Flexible connections between the pump and rigid piping will also assist in minimizing pump vibration. If quick-closing valves are installed at any point in the discharge system, or if pulsation within a system becomes a problem, a surge suppressor (SD Equalizer<sup>®</sup>) should be installed to protect the pump, piping and gauges from surges and water hammer.

If the pump is to be used in a self-priming application, make sure that all connections are airtight and that the suction lift is within the model's ability. **NOTE:** Materials of construction and elastomer material have an effect on suction lift parameters. Please refer to the performance section for specifics.

When pumps are installed in applications involving flooded suction or suction head pressures, a gate valve should be installed in the suction line to permit closing of the line for pump service.

Pumps in service with a positive suction head are most efficient when inlet pressure is limited to 0.5–0.7 bar (7–10 psig). Premature diaphragm failure may occur if positive suction is 0.7 bar (10 psig) and higher.

**SUBMERSIBLE APPLICATIONS:** Pro-Flo<sup>®</sup> SHIFT pumps can be used for submersible applications, when using the Pro-Flo<sup>®</sup> SHIFT's single-point exhaust option. Pro-Flo X<sup>™</sup> and Turbo-Flo<sup>®</sup> Pumps are also available in a single-point exhaust (submersible) configuration.

**NOTE:** Pro-Flo<sup>®</sup> and Accu-Flo<sup>™</sup> pumps do not have a single-point exhaust option and are not submersible.

**ALL WILDEN PUMPS ARE CAPABLE OF PASSING SOLIDS. A STRAINER SHOULD BE USED ON THE PUMP INTAKE TO ENSURE THAT THE PUMP'S RATED SOLIDS CAPACITY IS NOT EXCEEDED.**

**CAUTION: DO NOT EXCEED 8.6 BAR (125 PSIG) AIR SUPPLY PRESSURE.**

## SUGGESTED INSTALLATION

*This illustration is a generic representation of an air-operated double-diaphragm pump.*

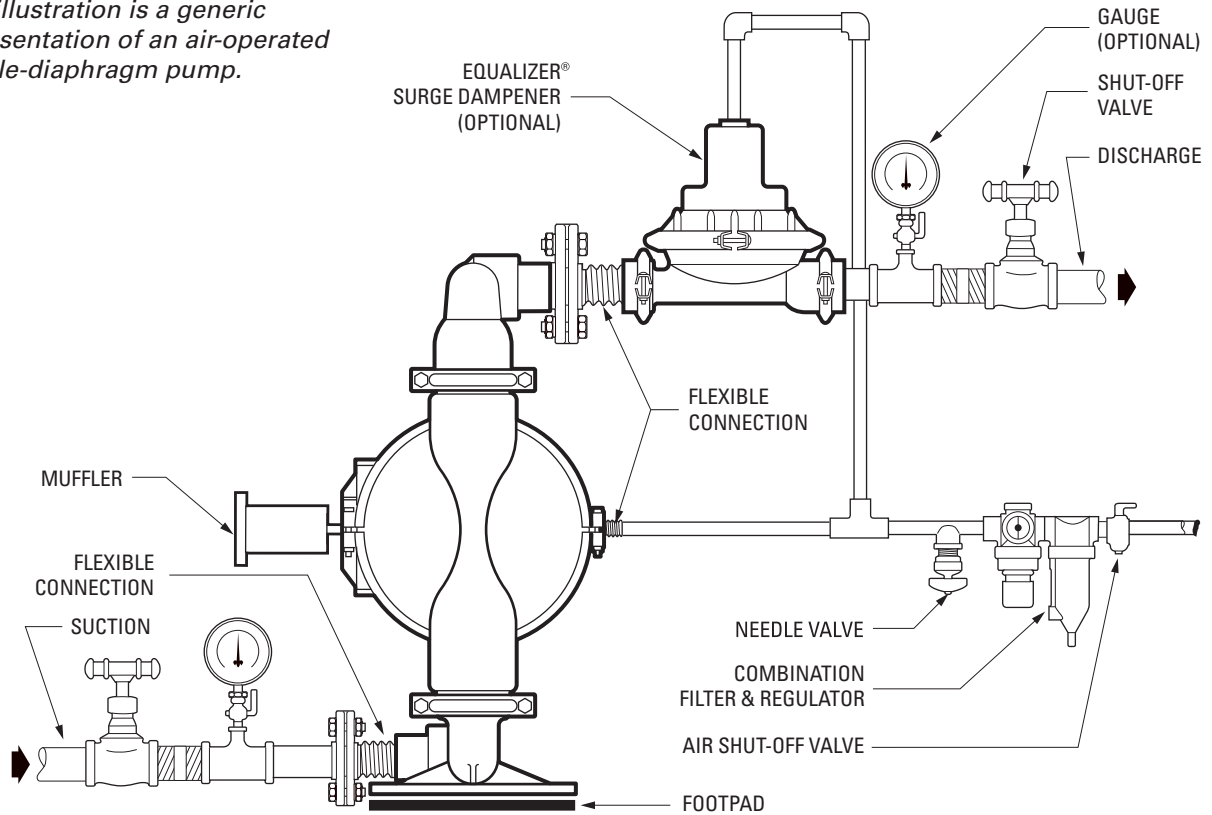

**NOTE:** In the event of a power failure, the shut-off valve should be closed, if the restarting of the pump is not desirable once power is regained.

**AIR-OPERATED PUMPS:** To stop the pump from operating in an emergency situation, simply close the

shut-off valve (user supplied) installed in the air supply line. A properly functioning valve will stop the air supply to the pump, therefore stopping output. This shut-off valve should be located far enough away from the pumping equipment such that it can be reached safely in an emergency situation.

## SUGGESTED OPERATION & MAINTENANCE

**OPERATION:** The Pro-Flo® SHIFT pumps are pre-lubricated and do not require in-line lubrication. Additional lubrication will not damage the pump; however if the pump is heavily lubricated by an external source, the pump's internal lubrication may be washed away. If the pump is then moved to a non-lubricated location, it may need to be disassembled and re-lubricated as described in the ASSEMBLY/DISASSEMBLY INSTRUCTIONS.

Pump discharge rate can be controlled by limiting the volume and/or pressure of the air supply to the pump. An air regulator is used to regulate air pressure. A needle valve is used to regulate volume. Pump discharge rate can also be controlled by throttling the pump discharge by partially closing a valve in the discharge line of the pump. This action increases friction loss which reduces flow rate. (See Section 5.) This is useful when the need exists to control the pump from a remote location. When the pump discharge pressure equals or exceeds the air supply pressure, the pump will stop; no bypass or pressure relief valve is needed, and pump damage will not occur. The pump has reached a "deadhead" situation

and can be restarted by reducing the fluid discharge pressure or increasing the air inlet pressure. Wilden Pro-Flo® SHIFT pumps run solely on compressed air and do not generate heat; therefore, your process fluid temperature will not be affected.

**MAINTENANCE AND INSPECTIONS:** Since each application is unique, maintenance schedules may be different for every pump. Frequency of use, line pressure, viscosity and abrasiveness of process fluid all affect the parts life of a Wilden pump. Periodic inspections have been found to offer the best means for preventing unscheduled pump downtime. Personnel familiar with the pump's construction and service should be informed of any abnormalities that are detected during operation.

**RECORDS:** When service is required, a record should be made of all necessary repairs and replacements. Over a period of time, such records can become a valuable tool for predicting and preventing future maintenance problems and unscheduled downtime. In addition, accurate records make it possible to identify pumps that are poorly suited to their applications.

## TROUBLESHOOTING

### ***Pump will not run or runs slowly.***

1. Ensure that the air inlet pressure is at least 0.4 bar (5 psig) above startup pressure and that the differential pressure (the difference between air inlet and liquid discharge pressures) is not less than 0.7 bar (10 psig).
2. Check air inlet filter for debris (see SUGGESTED INSTALLATION).
3. Check for extreme air leakage (blow by) which would indicate worn seals/bores in the air valve, pilot spool and main shaft.
4. Disassemble pump and check for obstructions in the air passageways or objects which would obstruct the movement of internal parts.
5. Check for sticking ball check valves. If material being pumped is not compatible with pump elastomers, swelling may occur. Replace ball check valves and seals with proper elastomers. Also, as the check valve balls wear out, they become smaller and can become stuck in the seats. In this case, replace balls and seats.
6. Check for broken inner piston which will cause the air valve spool to be unable to shift.
7. Remove plug from pilot spool exhaust.

### ***Pump runs but little or no product flows.***

1. Check for pump cavitation; slow pump speed down to allow thick material to flow into liquid chambers.

2. Verify that vacuum required to lift liquid is not greater than the vapor pressure of the material being pumped (cavitation).
3. Check for sticking ball check valves. If material being pumped is not compatible with pump elastomers, swelling may occur. Replace ball check valves and seats with proper elastomers. Also, as the check valve balls wear out, they become smaller and can become stuck in the seats. In this case, replace balls and seats.

### ***Pump air valve freezes.***

1. Check for excessive moisture in compressed air. Either install a dryer or hot air generator for compressed air. Alternatively, a coalescing filter may be used to remove the water from the compressed air in some applications.

### ***Air bubbles in pump discharge.***

1. Check for ruptured diaphragm.
2. Check tightness of outer pistons (refer to Section 7).
3. Check tightness of fasteners and integrity of O-rings and seals, especially at intake manifold.
4. Ensure pipe connections are airtight.

### ***Product comes out air exhaust.***

1. Check for diaphragm rupture.
2. Check tightness of outer pistons to shaft.

## PUMP DISASSEMBLY

### Tools Required:

- Appropriate-sized Wrench
- Adjustable Wrench
- Vise equipped w/ soft jaws (such as plywood, plastic or other suitable material)

**CAUTION:** Before any maintenance or repair is attempted, the compressed air line to the pump should be disconnected and all air pressure allowed to bleed from the pump. Disconnect all intake, discharge and air lines. Drain the pump by turning it upside down and allowing any fluid to flow into a suitable container. Be aware of any hazardous effects of contact with your process fluid.

**NOTE:** The model photographed is an aluminum PS4 38 mm (1-1/2") pump. Your specific pump model may vary from configuration shown.

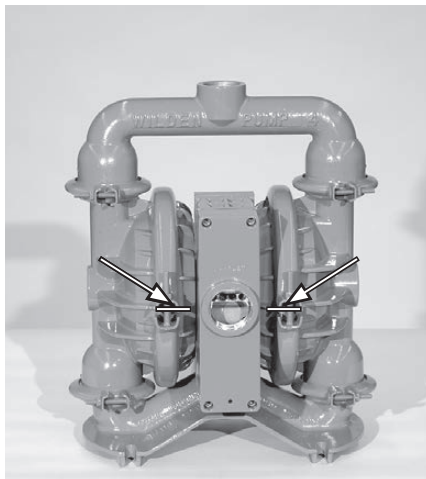

### Step 1

Before starting disassembly, mark a line from each liquid chamber to its corresponding air chamber. This line will assist in proper alignment during reassembly.

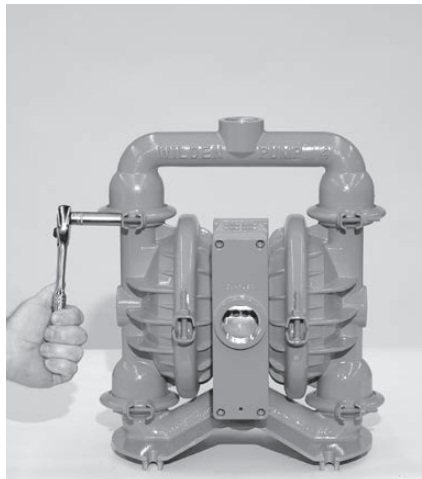

### Step 2

Using an appropriate-sized wrench, remove the two (2) small clamp bands that fasten the discharge manifold to the liquid chambers.

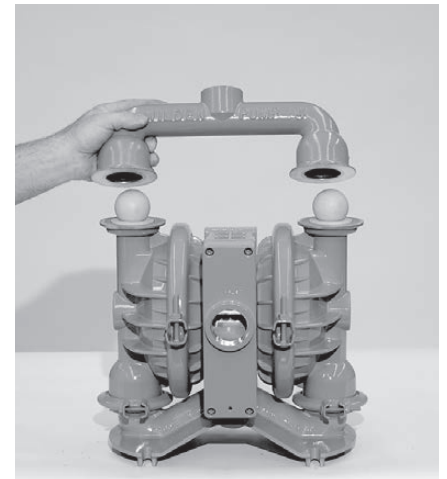

### Step 3

Lift the discharge manifold to expose discharge valve balls and valve seats. Inspect ball cage area of manifold for excessive wear or damage.

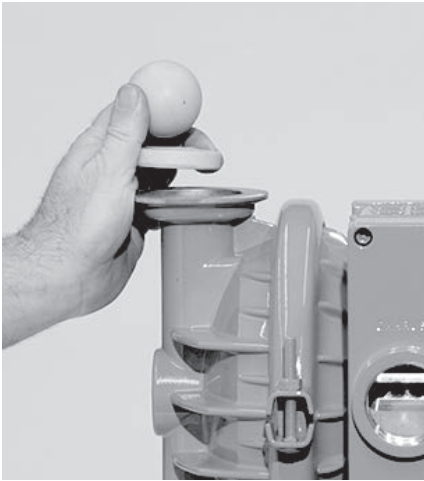

**Step 4**

Remove the discharge valve balls and valve seats from the liquid chambers and inspect for nicks, chemical attack or abrasive wear. Replace worn parts with genuine Wilden parts for reliable performance.

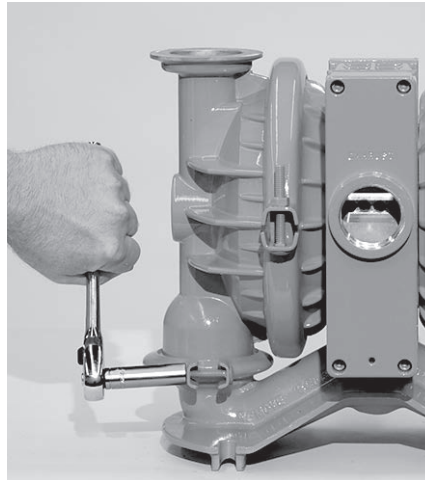

**Step 5**

Using an appropriate-sized wrench, remove the two (2) small clamp bands that fasten the inlet manifold to the liquid chambers.

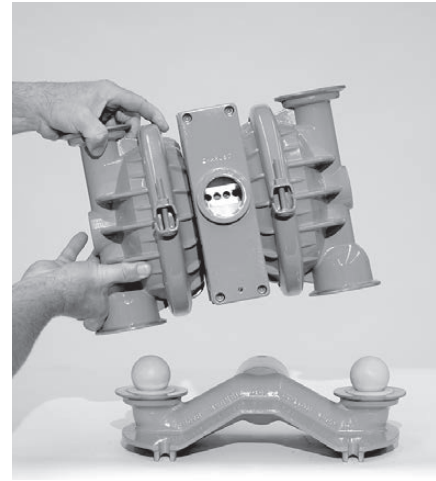

**Step 6**

Lift the liquid chambers and center section assembly from the inlet manifold to expose the inlet valve balls and valve seats. Inspect ball cage area of inlet manifold for excessive wear or damage.



**Step 7**

Remove the inlet valve balls and valve seats from the inlet manifold and inspect for nicks, chemical attack or abrasive wear. Replace worn parts with genuine Wilden parts for reliable performance.

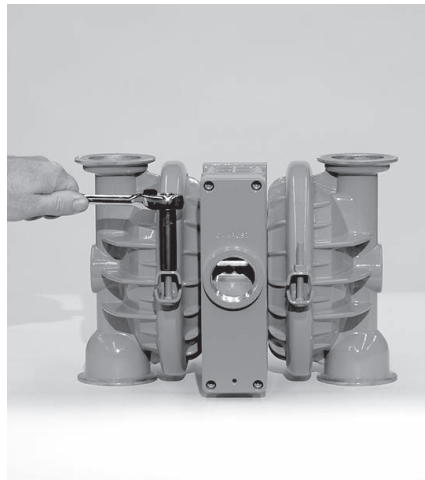

**Step 8**

Using an appropriate-sized wrench, remove one set of large clamp bands that secure one liquid chamber to the center section.



**Step 9**

Pull liquid chamber away from the center section to expose diaphragm and outer piston. Remove other side of the liquid chamber from center section.



**Step 10**

Using two adjustable wrenches, turn the outer diaphragm pistons in a counter-clockwise direction to remove the diaphragm assembly from center block. Inspect diaphragm assembly and shaft for signs of wear or chemical attack. Replace all worn parts with genuine Wilden parts for reliable performance.



**Step 11**

Inspect the diaphragm assembly for wear, damage or chemical attack. Replace any damaged components with genuine Wilden parts for reliable performance.

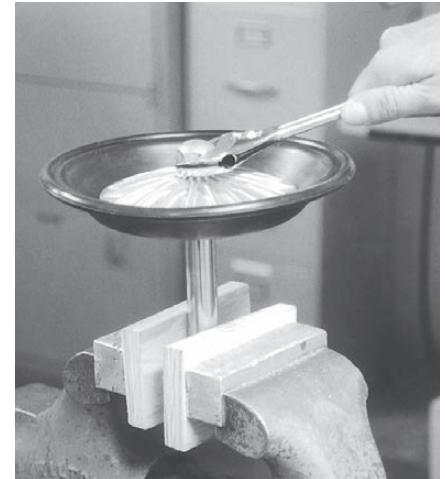

**Step 12**

To remove diaphragm assembly from shaft, secure shaft with soft jaws (aluminum, plastic or plywood) to ensure the shaft is not damaged. Using an adjustable wrench, remove the diaphragm assembly from the shaft.

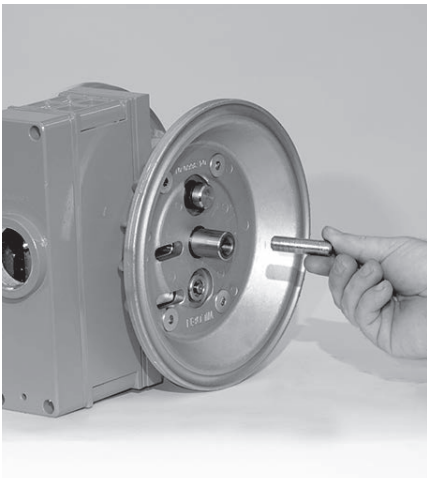

**Step 13**

Remove outer piston and stud if equipped. Inspect for wear and replace if necessary.

## AIR VALVE / CENTER SECTION DISASSEMBLY

### Tools Required:

- Appropriate-sized Wrench
- Snap Ring Pliers
- O-Ring Pick

**CAUTION:** Before any maintenance or repair is attempted, the compressed air line to the pump should be disconnected and all air pressure allowed to bleed from the pump. Disconnect all intake, discharge and air lines. Drain the pump by turning it upside down and allowing any fluid to flow into a suitable container. Be aware of hazardous effects of contact with your process fluid.

The Wilden Pro-Flo® SHIFT metal pumps utilize a revolutionary Pro-Flo® SHIFT air distribution system. Proprietary composite seals reduce the coefficient of friction and allow the Pro-Flo® SHIFT to run lube-free. Constructed of aluminum, the Pro-Flo® SHIFT air distribution system is designed to perform in on/off, non-freezing, non-stalling, tough duty applications.



**Step 1**

Using a pair of snap ring pliers, remove the snap ring from pilot sleeve.



**Step 2**

Using an O-ring pick, remove O-ring from modulator spool.



**Step 3**

Using the appropriate-sized wrench, loosen and remove the fasteners that attach the air chamber to center section.



## AIR VALVE / CENTER SECTION DISASSEMBLY

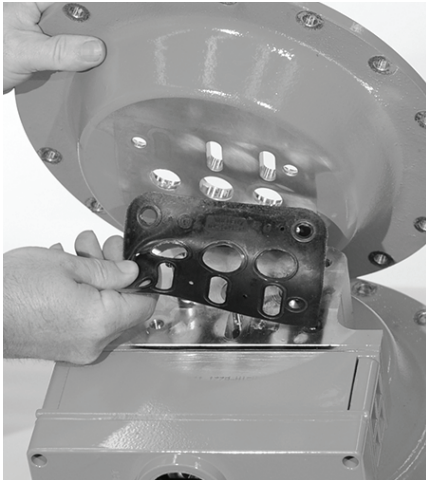

### Step 4

Lift away air chamber from center section and remove center block gasket. Replace gasket if necessary.



### Step 5

Turn assembly over and remove the pilot spool sleeve from the center section.



### Step 6

Using an O-ring pick, gently remove the O-ring from the opposite side of the dimpled end of the pilot spool.



### Step 7

Gently remove the pilot spool from the sleeve and inspect for nicks, wear or damage. Replace the pilot spool assembly or sleeve O-rings if necessary. During reassembly, never insert the dimpled end of the pilot spool first, this will damage the single urethane O-ring by passing it over the ports in the pilot sleeve.

**NOTE:** Seals should not be removed from the assembly. Seals are not sold separately.



### Step 8

Remove modulator spool from center section. Check for wear to spool or O-rings and replace if necessary.



### Step 9

Using the appropriate-sized wrench, loosen the fasteners to remove remaining air chamber and center block gasket from center section. Replace gasket if necessary.

## AIR VALVE / CENTER SECTION DISASSEMBLY

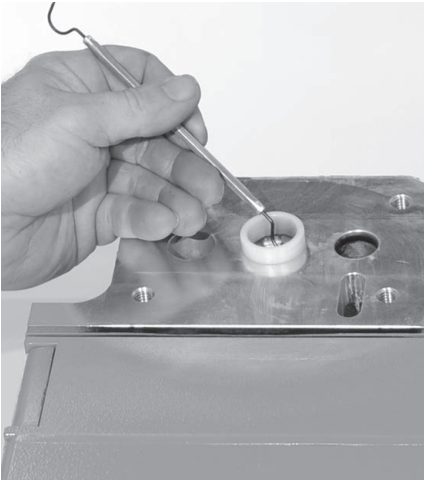

### Step 10

Using an O-ring pick, remove the two (2) shaft bushings from center block. Inspect and replace if necessary. Using an O-ring pick, gently remove the two (2) Glyd™ rings from the center block. Inspect and replace if necessary.

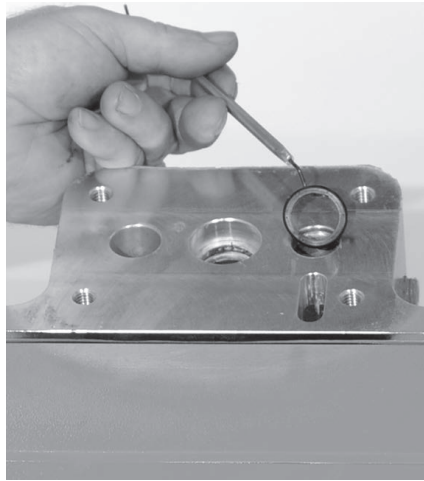

### Step 11

Using an O-ring pick, remove the two (2) Glyd™ rings from modulator spool bore. Inspect and replace if necessary.



### Step 12

Using an appropriate-sized wrench, remove the pilot exhaust muffer. Inspect for damage or contamination and replace if necessary.



### Step 13

Using an appropriate-sized hex wrench, loosen and remove the four (4) air valve bolts from center section assembly.

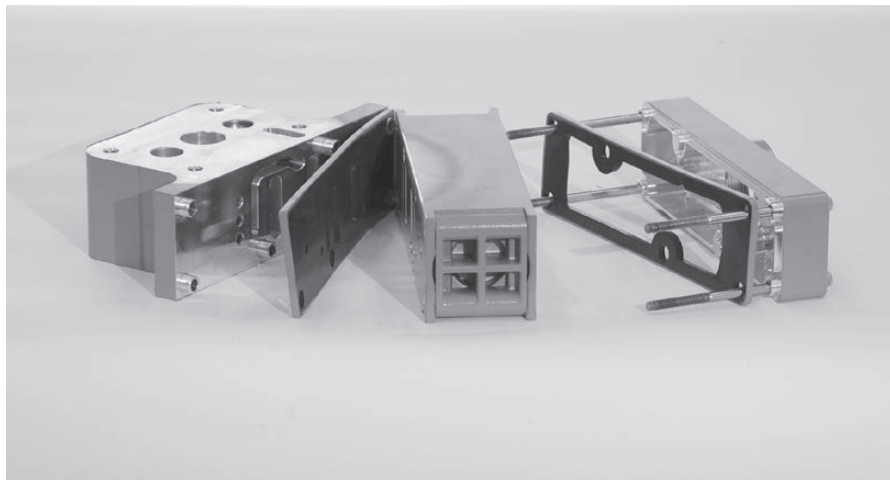

### Step 14

Lift away muffer plate and muffer plate gasket from center block. Inspect for wear and replace if necessary. Lift away the air valve assembly and remove air valve gasket. Inspect the gasket and replace if necessary.

## AIR VALVE / CENTER SECTION DISASSEMBLY

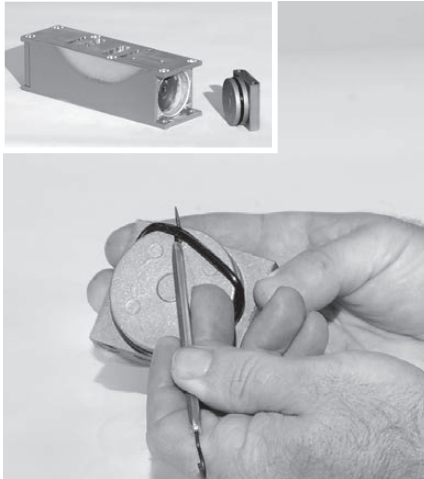

### Step 15

Remove air valve end cap to expose air valve spool by lifting up on end cap. Inspect O-ring on end cap using an O-ring pick. Replace O-ring(s) if necessary. NOTE: The Pro-Flo® SHIFT air valve incorporates an end cap at both ends of the air valve.

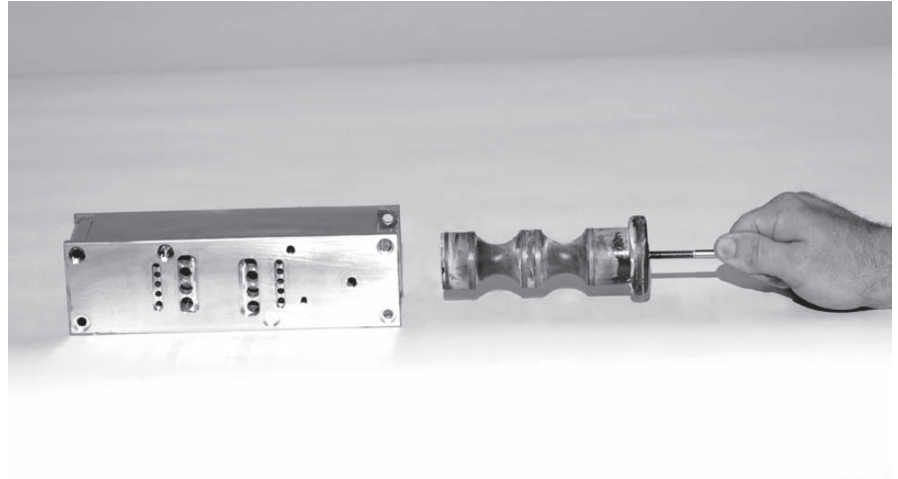

### Step 16

Remove the air valve spool from the air valve body by threading one air valve bolt into the end of the air valve spool and gently sliding the spool out of the air valve body. Inspect seals for signs of wear and replace the entire air valve assembly if necessary. Re-insert the spool immediately into air valve body after inspection as the seals expand and cannot be reinserted after a length of time.

NOTE: Seals should not be removed from the assembly. Seals are not sold separately.

## SINGLE-POINT EXHAUST PRO-FLO® SHIFT

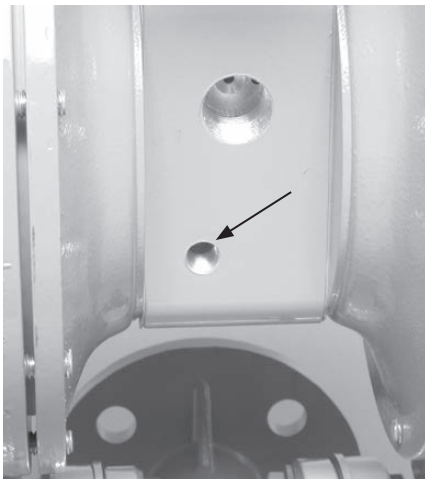

### Step 1

Remove pilot exhaust muffler in pilot bleed port located at the front of the center block. Install 1/4" NPT pipe plug (00-7010-08) into bleed port.



Standard



Single-Point Exhaust

### Step 2

Next, install an optional single-point exhaust gasket (04-2628-52). The single-point air valve gasket can be purchased as a spare part or included with the purchase of a new Pro-Flo® SHIFT pump.

## REASSEMBLY HINTS & TIPS

### ASSEMBLY:

Upon performing applicable maintenance to the air distribution system, the pump can now be reassembled. Please refer to the disassembly instructions for photos and parts placement. To reassemble the pump, follow the disassembly instructions in reverse order. The air distribution system needs to be assembled first, then the diaphragms and finally the wetted path. Please find the applicable torque specifications on this page. The following tips will assist in the assembly process.

- Lubricate air valve bore, center section shaft and pilot spool bore with NLGI grade 2 white EP bearing grease or equivalent.
- Clean the inside of the center section shaft bore to ensure no damage is done to new shaft seals.
- A small amount of NLGI grade 2 white EP bearing grease can be applied to the muffler and air valve gaskets to locate gaskets during assembly.
- Make sure that the exhaust port on the muffler plate is centered between the two exhaust ports on the center section.
- Stainless bolts should be lubed to reduce the possibility of seizing during tightening.

### PRO-FLO® Shift MAXIMUM TORQUE SPECIFICATIONS

Description of Part	Torque
Air Valve	13.6 N•m (120 in-lbs)
Air Chamber/Center Block	27.1 N•m (20 ft-lbs)
Inner Piston Ring	19.0 N•m (14 ft-lbs)
Outer Pistons, Rubber & PTFE	135.6 N•m (100 ft-lbs)

### SHAFT SEAL INSTALLATION:

#### PRE-INSTALLATION

- Once all of the old seals have been removed, the inside of the bushing should be cleaned to ensure no debris is left that may cause premature damage to the new seals.

#### INSTALLATION

The following tools can be used to aid in the installation of the new seals:

Needle Nose Pliers  
Phillips Screwdriver  
Electrical Tape

- Wrap electrical tape around each leg of the needle nose pliers (heat shrink tubing may also be used). This is done to prevent damaging the inside surface of the new seal.
- With a new seal in hand, place the two legs of the needle nose pliers inside the seal ring. (See Figure A.)
- Open the pliers as wide as the seal diameter will allow, then with two fingers pull down on the top portion of the seal to form kidney bean shape. (See Figure B.)
- Lightly clamp the pliers together to hold the seal into the kidney shape. Be sure to pull the seal into as tight of a kidney shape as possible, this will allow the seal to travel down the bushing bore with greater ease.
- With the seal clamped in the pliers, insert the seal into the bushing bore and position the bottom of the seal into the correct groove. Once the bottom of the seal is seated in the groove, release the clamp pressure on the pliers. This will allow the seal to partially snap back to its original shape.
- After the pliers are removed, you will notice a slight bump in the seal shape. Before the seal can be properly resized, the bump in the seal should be removed as much as possible. This can be done with either the Phillips screwdriver or your finger. With either the side of the screwdriver or your finger, apply light pressure to the peak of the bump. This pressure will cause the bump to be almost completely eliminated.
- Lubricate the edge of the shaft with NLGI grade 2 white EP bearing grease.
- Slowly insert the center shaft with a rotating motion. This will complete the resizing of the seal.
- Perform these steps for the remaining seal.

Figure A

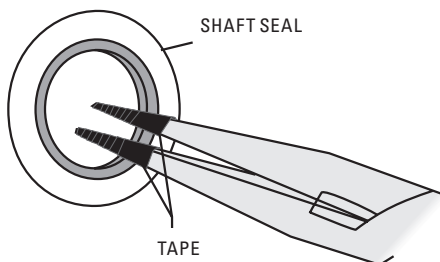
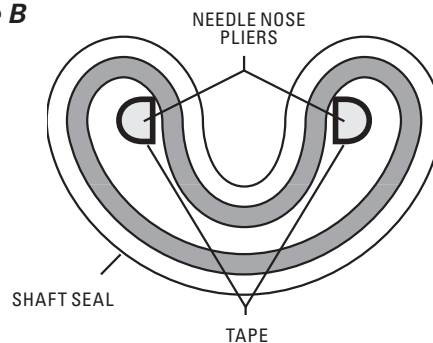

Figure B



**NOTES**



EXPLODED VIEW & PARTS LISTING

PS8 METAL

EXPLODED VIEW

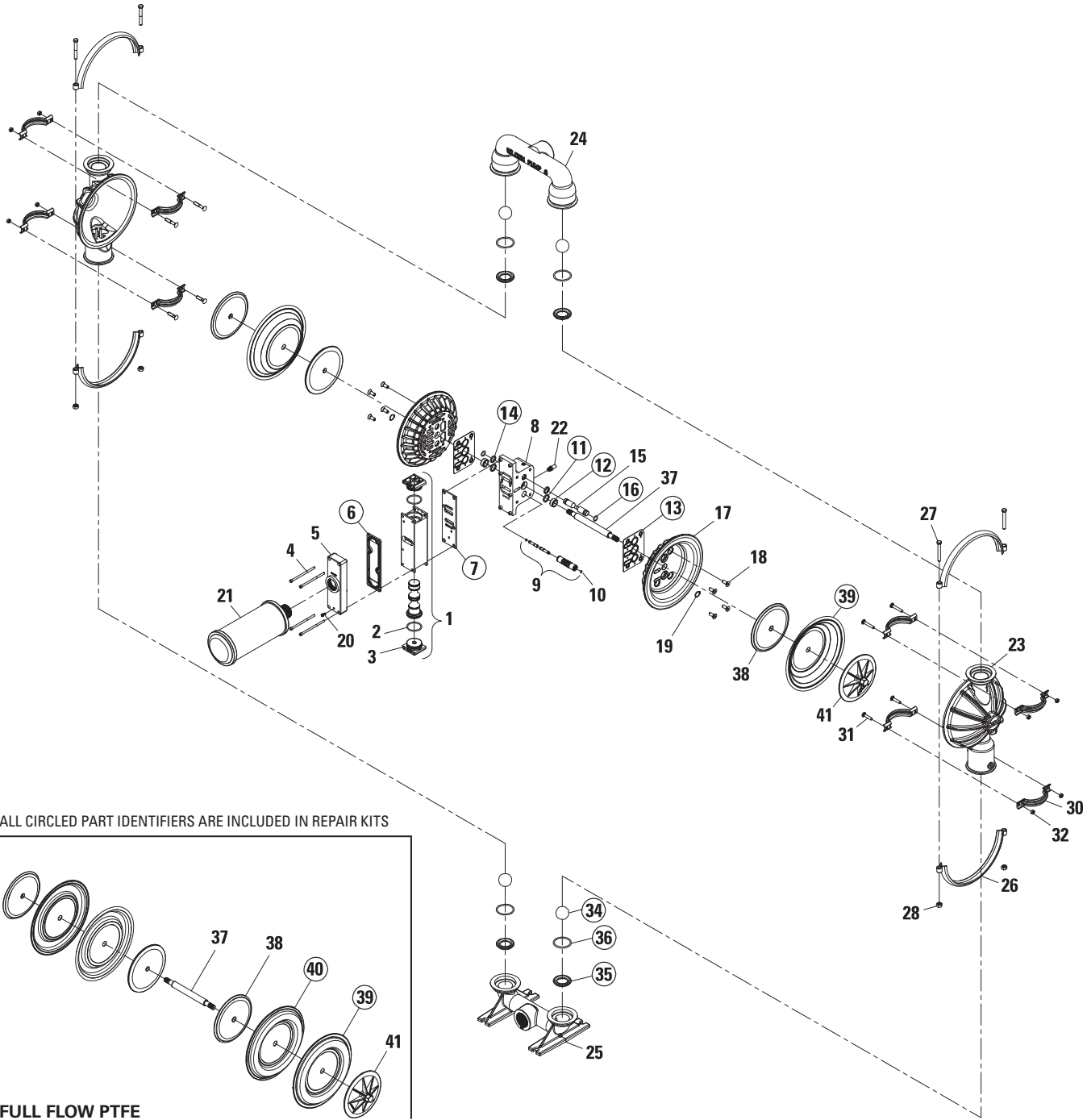

ALL CIRCLED PART IDENTIFIERS ARE INCLUDED IN REPAIR KITS

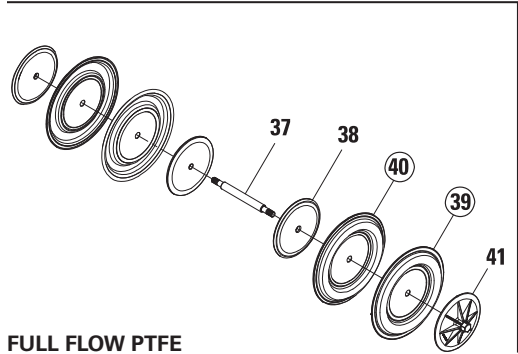

LW0027 REV. B



# EXPLODED VIEW & PARTS LISTING

## PS8 METAL

## PARTS LISTING

Item	Description	Qty.	XPS8/AAAAA/ P/N	XPS8/WWAAA/ P/N	XPS8/SSAAA/ P/N	XPS8/SSAAA/.../0070 P/N
<b>AIR DISTRIBUTION COMPONENTS</b>						
<b>1</b>	<b>Air Valve Assembly, Pro-Flo® SHIFT <sup>1</sup></b>	<b>1</b>	<b>04-2039-01</b>	<b>04-2039-01</b>	<b>04-2039-01</b>	<b>04-2039-01</b>
<b>2</b>	<b>O-Ring (-225), End Cap (Ø1.859" x Ø.139")</b>	<b>2</b>	<b>04-2390-52-700</b>	<b>04-2390-52-700</b>	<b>04-2390-52-700</b>	<b>04-2390-52-700</b>
3	End Cap	2	04-2340-01	04-2340-01	04-2340-01	04-2340-01
4	Screw, SHC, Air Valve (1/4"-20 x 4-1/2")	4	01-6000-03	01-6000-03	01-6000-03	01-6000-03
5	Muffler Plate, Pro-Flo® SHIFT	1	04-3189-01	04-3189-01	04-3189-01	04-3189-01
<b>6</b>	<b>Gasket, Muffler Plate, Pro-Flo® SHIFT</b>	<b>1</b>	<b>04-3509-52</b>	<b>04-3509-52</b>	<b>04-3509-52</b>	<b>04-3509-52</b>
<b>7</b>	<b>Gasket, Air Valve, Pro-Flo® SHIFT</b>	<b>1</b>	<b>04-2629-52</b>	<b>04-2629-52</b>	<b>04-2629-52</b>	<b>04-2629-52</b>
8	Center Block Assembly, Pro-Flo® SHIFT <sup>2</sup>	1	04-3129-01	04-3129-01	04-3129-01	04-3129-01
<b>9</b>	<b>Pilot Sleeve Assembly</b>	<b>1</b>	<b>04-3880-99</b>	<b>04-3880-99</b>	<b>04-3880-99</b>	<b>04-3880-99</b>
<b>10</b>	<b>O-Ring (-009), Pilot Spool Retaining (Ø.208" x Ø.070")</b>	<b>2</b>	<b>04-2650-49-700</b>	<b>04-2650-49-700</b>	<b>04-2650-49-700</b>	<b>04-2650-49-700</b>
<b>11</b>	<b>Seal, Shaft</b>	<b>2</b>	<b>08-3210-55-225</b>	<b>08-3210-55-225</b>	<b>08-3210-55-225</b>	<b>08-3210-55-225</b>
<b>12</b>	<b>Bushing, Shaft</b>	<b>2</b>	<b>08-3306-13</b>	<b>08-3306-13</b>	<b>08-3306-13</b>	<b>08-3306-13</b>
<b>13</b>	<b>Gasket, Center Block Pro-Flo V™</b>	<b>2</b>	<b>04-3529-52</b>	<b>04-3529-52</b>	<b>04-3529-52</b>	<b>04-3529-52</b>
<b>14</b>	<b>Seal, Air Control Spool</b>	<b>2</b>	<b>02-3210-55-225</b>	<b>02-3210-55-225</b>	<b>02-3210-55-225</b>	<b>02-3210-55-225</b>
<b>15</b>	<b>Air Control Spool</b>	<b>1</b>	<b>04-3859-03</b>	<b>04-3859-03</b>	<b>04-3859-03</b>	<b>04-3859-03</b>
<b>16</b>	<b>O-ring, (-114) Air Control Spool Retaining (Ø.612" x Ø.103")</b>	<b>2</b>	<b>04-3879-50</b>	<b>04-3879-50</b>	<b>04-3879-50</b>	<b>04-3879-50</b>
17	Air Chamber, Pro-Flo V™	2	08-3660-01	08-3660-01	08-3660-01	08-3660-01
18	Screw, HSFHS (3/8"-16 x 1")	8	71-6250-08	71-6250-08	71-6250-08	71-6250-08
19	Retaining Ring	2	04-3890-03	04-3890-03	04-3890-03	04-3890-03
20	Grounding Screw, (10-32 x .50") Self Tapping	1	04-6345-08	04-6345-08	04-6345-08	04-6345-08
21	Muffler 1-1/2" NPT	1	04-3518-99R	04-3518-99R	04-3518-99R	04-3518-99R
22	Muffler 1/4" NPT	1	04-3240-07	04-3240-07	04-3240-07	04-3240-07
<b>WETTED PATH COMPONENTS</b>						
23	Liquid Chamber	2	08-5000-01	08-5000-02	08-5000-03	08-5000-03P
24	Manifold, Discharge NPT	1	08-5020-01	08-5020-02	08-5020-03	N/A
	Manifold, Discharge BSPT	1	08-5020-01-14	08-5020-02-14	08-5020-03-14	N/A
	Manifold, Discharge Tri-Clamp	1	N/A	N/A	N/A	08-5020-03-70P
25	Manifold, Footed Inlet NPT	1	08-5080-01	08-5080-02	08-5080-03	N/A
	Manifold, Footed Inlet BSPT	1	08-5080-01-14	08-5080-02-14	08-5080-03-14	N/A
	Manifold, Footed Inlet Tri-Clamp	1	N/A	N/A	N/A	08-5080-03-70P
26	Large Clamp Band Assembly	2	08-7300-08	08-7300-08	08-7300-03	08-7300-03
27	Screw, HHC Large (3/8"-16 x 3")	4	08-6120-08	08-6120-08	08-6120-03	08-6120-03
28	Large Hex Nut (3/8"-16)	4	08-6450-08	08-6450-08	08-6450-03	08-6671-10
29	Washer, Brass Flat (Ø.392" x Ø.875" x .063") (not shown)	4	N/A	N/A	N/A	08-6720-07-70
30	Small Clamp Band Assembly	4	08-7100-08	08-7100-08	08-7100-03	08-7100-08
31	Screw, HHC Small (5/16"-18 x 1-1/2")	8	08-6050-08	08-6050-08	08-6050-03	08-6050-03
32	Small Hex Nut (5/16"-18)	8	04-6420-08	04-6420-08	04-6400-03	08-6661-10
33	Washer, Brass Flat (Ø.340" x Ø.750" x .063") (not shown)	8	N/A	N/A	N/A	08-6700-07-70
<b>GASKETS/VALVE BALLS/VALVE SEATS/VALVE O-RINGS</b>						
<b>34</b>	<b>Ball, Valve</b>	<b>4</b>	<b>*</b>	<b>*</b>	<b>*</b>	<b>*</b>
<b>35</b>	<b>Seat, Valve</b>	<b>4</b>	<b>*</b>	<b>*</b>	<b>*</b>	<b>08-1121-03P</b>
<b>36</b>	<b>O-Ring, (-334) Valve Seat, PTFE Fitted (Ø2.600 x Ø.210)</b>	<b>4</b>	<b>08-1200-55</b>	<b>08-1200-55</b>	<b>08-1200-55</b>	<b>08-1200-55</b>
<b>FULL STROKE RUBBER/TPE/PTFE COMPONENTS</b>						
37	Shaft (Rubber)	1	08-3810-09	08-3810-09	08-3810-09	08-3810-09
	Shaft (EZ TPE/PTFE)	1	08-3812-03	08-3812-03	08-3812-03	08-3812-03
38	Piston, Inner	2	08-3700-01	08-3700-01	08-3700-01	08-3700-01
<b>39</b>	<b>Diaphragm, Primary</b>	<b>2</b>	<b>*</b>	<b>*</b>	<b>*</b>	<b>*</b>
<b>40</b>	<b>Diaphragm, Back-Up</b>	<b>2</b>	<b>*</b>	<b>*</b>	<b>*</b>	<b>*</b>
41	Piston, Outer	2	08-4550-01	08-4550-02	08-4550-03	08-4550-03P

\*See elastomer chart - Section 9

<sup>1</sup>Air Valve Assembly includes items 2 and 3

<sup>2</sup>Metal Center Block Assembly includes item 11, 12, 14, 15 and 16

**All boldface items are primary wear parts.**



## ELASTOMER OPTIONS

## PS8 Metal

MATERIAL	DIAPHRAGM (2)	BACK-UP DIAPHRAGMS FULL STROKE (2)	VALVE BALLS (4)	VALVE SEATS (4)	VALVE SEAT O-RING (4)
Polyurethane	08-1022-50	N/A	08-1080-50	08-1120-50	N/A
Neoprene	08-1010-51	N/A	08-1080-51	08-1120-51	N/A
Buna-N	08-1010-52	N/A	08-1080-52	08-1120-52	N/A
FDA Buna-N <sup>2</sup>	08-1010-69	N/A	N/A	N/A	N/A
Conductive Buna-N	08-1010-86	N/A	N/A	N/A	N/A
Geolast®	08-1022-15	N/A	N/A	N/A	N/A
EPDM	08-1010-54	N/A	08-1080-54	08-1120-54	N/A
FDA EPDM <sup>2</sup>	08-1010-74	N/A	N/A	N/A	N/A
Viton®	08-1010-53	N/A	08-1080-53	08-1120-53	N/A
Full Stroke PTFE <sup>2</sup>	08-1040-55	N/A	08-1080-55	N/A	08-1200-55 <sup>1</sup>
Saniflex™ <sup>2</sup>	08-1022-56	08-1065-56	08-1080-56	08-1120-56	N/A
FDA Wil-Flex™ <sup>2</sup>	08-1022-57	08-1065-57	08-1080-57	08-1120-57	N/A
Wil-Flex™	08-1022-58	N/A	08-1080-58	08-1120-58	N/A
Aluminum	N/A	N/A	N/A	08-1121-01	N/A
Stainless Steel	N/A	N/A	N/A	08-1121-03	N/A
Alloy C	N/A	N/A	N/A	08-1121-04	N/A
Mild Steel	N/A	N/A	N/A	08-1121-08	N/A

<sup>1</sup>Used in conjunction with metallic valve seat

LW0043 Rev. D

<sup>2</sup>Elastomer option for use in Saniflo™ FDA pumps (Specialty Code 0070)



**NOTES**

**NOTES**

## WARRANTY

Each and every product manufactured by Wilden Pump and Engineering, LLC is built to meet the highest standards of quality. Every pump is functionally tested to insure integrity of operation.

Wilden Pump and Engineering, LLC warrants that pumps, accessories and parts manufactured or supplied by it to be free from defects in material and workmanship for a period of five (5) years from date of installation or six (6) years from date of manufacture, whichever comes first. Failure due to normal wear, misapplication, or abuse is, of course, excluded from this warranty.

Since the use of Wilden pumps and parts is beyond our control, we cannot guarantee the suitability of any pump or part for a particular application and Wilden Pump and Engineering, LLC shall not be liable for any consequential damage or expense arising from the use or misuse of its products on any application. Responsibility is limited solely to replacement or repair of defective Wilden pumps and parts.

All decisions as to the cause of failure are the sole determination of Wilden Pump and Engineering, LLC.

Prior approval must be obtained from Wilden for return of any items for warranty consideration and must be accompanied by the appropriate MSDS for the product(s) involved. A Return Goods Tag, obtained from an authorized Wilden distributor, must be included with the items which must be shipped freight prepaid.

The foregoing warranty is exclusive and in lieu of all other warranties expressed or implied (whether written or oral) including all implied warranties of merchantability and fitness for any particular purpose. No distributor or other person is authorized to assume any liability or obligation for Wilden Pump and Engineering, LLC other than expressly provided herein.

### PLEASE PRINT OR TYPE AND FAX TO WILDEN

PUMP INFORMATION			
Item # _____		Serial # _____	
Company Where Purchased _____			
YOUR INFORMATION			
Company Name _____			
Industry _____			
Name _____		Title _____	
Street Address _____			
City _____		State _____	Postal Code _____
Country _____			
Telephone _____		Fax _____	E-mail _____
Web Address _____			
Number of pumps in facility? _____		Number of Wilden pumps? _____	
Types of pumps in facility (check all that apply): <input type="checkbox"/> Diaphragm <input type="checkbox"/> Centrifugal <input type="checkbox"/> Gear <input type="checkbox"/> Submersible <input type="checkbox"/> Lobe			
<input type="checkbox"/> Other _____			
Media being pumped? _____			
How did you hear of Wilden Pump? <input type="checkbox"/> Trade Journal <input type="checkbox"/> Trade Show <input type="checkbox"/> Internet/E-mail <input type="checkbox"/> Distributor			
<input type="checkbox"/> Other _____			

**ONCE COMPLETE, FAX TO (909) 783-3440**

NOTE: WARRANTY VOID IF PAGE IS NOT FAXED TO WILDEN  
WILDEN PUMP & ENGINEERING, LLC

## PSG Brands

**ABAQUE™**  
PERISTALTIC PUMPS  
mouvex.com

**ALMATEC®**  
AIR-OPERATED  
DOUBLE-DIAPHRAGM PUMPS  
almatec.de

**AUTOMATIK**  
PELLETIZING SYSTEMS  
maag.com

**BLACKMER®**  
VANE PUMPS & COMPRESSORS  
blackmer.com

**FLUID DYNAMICS™**  
POLYMER BLENDING SYSTEMS  
fluiddynamics1.com

**GRISWOLD™**  
CENTRIFUGAL PUMPS  
griswoldpump.com

**MAAG  
FILTRATION**  
PLASTIC MANUFACTURING &  
PROCESSING FILTRATION  
maag.com

**MAAG  
INDUSTRIAL PUMPS**  
GEAR & SCREW PUMPS  
maag.com

**MAAG  
PUMP SYSTEMS**  
EXTRUSION PUMPS & SYSTEMS  
maag.com

**MOUVEX®**  
ECCENTRIC DISC PUMPS,  
VANE PUMPS &  
COMPRESSORS  
mouvex.com

**NEPTUNE™**  
DIAPHRAGM (METERING) PUMPS,  
POLYMER SYSTEMS & MIXERS  
neptune1.com

**QUATTROFLOW™**  
QUATERNARY DIAPHRAGM  
PUMP TECHNOLOGY  
quattroflow.com

**REDSCREW™**  
SCREW PUMPS  
redscrewpump.com

**SYSTEM ONE®**  
CENTRIFUGAL PUMPS  
blackmer.com

**WILDEN®**  
AIR-OPERATED  
DOUBLE-DIAPHRAGM PUMPS  
wildenpump.com



## Where Innovation Flows

PSG reserves the right to modify the information and illustrations contained in this document without prior notice. This is a non-contractual document. 01-2013

Authorized PSG Representative:

**WILDEN®**  
Part of Pump Solutions Group  
A DOVER COMPANY

22069 Van Buren St.  
Grand Terrace, CA 92313-5607  
T: +1 (909) 422-1731  
F: +1 (909) 783-3440

Copyright 2013, Pump Solutions Group (PSG), A Dover Company