

SINEAX V 604

Programmable Universal Transmitter

for DC currents or voltages, temperature sensors, remote sensors or potentiometers



Application

The universal transmitter **SINEAX V 604** (figure 1) converts the input variable – a DC current or voltage, or a signal from a thermocouple, resistance thermometer, remote sensor or potentiometer – to a proportional analog output signal.

The analog output signal is either an impressed current or superimposed voltage which is processed by other devices for purposes of displaying, recording and/or regulating a constant.

A considerable number of measuring ranges including bipolar or spread ranges are available.

Input variable and measuring range are programmed with the aid of a PC and the corresponding software. Other parameters relating to specific input variable data, the analog output signal, the transmission mode, the operating sense and the open-circuit sensor supervision can also be programmed.

The open-circuit sensor supervision is in operation when the SINEAX V 604 is used in conjunction with a thermocouple, resistance thermometer, remote sensor or potentiometer.

The transmitter fulfils all the important requirements and regulations concerning electromagnetic compatibility **EMC** and **Safety** (IEC 1010 resp. EN 61 010). It was developed and is manufactured and tested in strict accordance with the **quality assurance standard** ISO 9001.

Production QA is also certified according to guideline 94/9/EG.

Features / Benefits

- **Input variable** (temperatures, variation of resistance, DC signal) and **measuring range programmed using PC / Simplifies project planning and engineering** (the final measuring range can be determined during commissioning). **Short delivery times and low stocking levels**
- **Analog output signal also programmed on the PC** (impressed current or superimposed voltage for all ranges between – 20 and + 20 mA DC resp. –12 and + 15 V DC) / **Universally applicable. Short delivery times and low stocking levels**
- **Electric insulation between measured variable, analog output signal and power supply / Safe isolation acc. to EN 61 010**

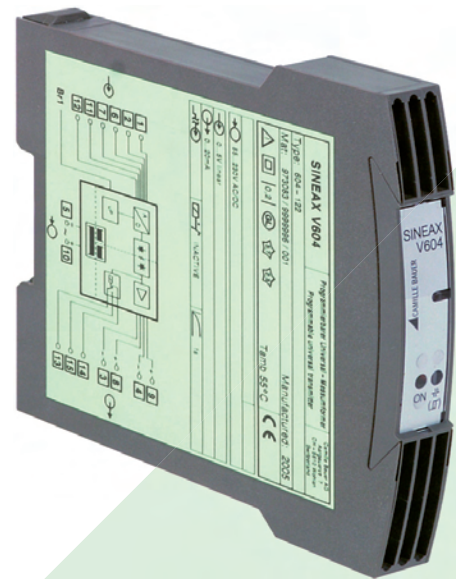

Fig. 1. Transmitter SINEAX V 604 in housing S17.

- **Wide power supply tolerance / Only two operating voltage ranges between 20 and a maximum of 264 V DC/AC**
- **Available in type of protection “Intrinsic safety” [Ex ia] IIC** (see “Table 7: Data on explosion protection”)
- **Ex devices also directly programmable on site / No supplementary Ex interface needed**
- **Standard version as per Germanischer Lloyd**
- **Provision for either snapping the transmitter onto top-hat rails or securing it with screws to a wall or panel**
- **Housing only 17.5 mm wide (size S17 housing) / Low space requirement**
- **Other programmable parameters: specific measured variable data** (e.g. two, three or four-wire connection for resistance thermometers, “internal” or “external” cold junction compensation of thermocouples etc.), **transmission mode** (special linearised characteristic or characteristic determined by a mathematical relationship, e.g. output signal = f (measured variable)), **operating sense** (output signal directly or inversely proportional to the measured variable) and **open-circuit sensor supervision** (output signal assumes fixed preset value between – 10 and 110%, supplementary output contact signalling relay) / **Highly flexible solutions for measurement problems**

SINEAX V 604

Programmable Universal Transmitter

- All programming operations by IBM XT, AT or compatible PC running the self-explanatory, menu-controlled programming software, if necessary, during operation / No ancillary hand-held terminals needed
- Digital measured variable data available at the programming interface / Simplifies commissioning, measured variable and signals can be viewed on PC in the field
- Standard software includes functional test program / No external simulator or signal injection necessary
- Self-monitoring function and continuously running test program / Automatic signalling of defects and device failure

Principle of operation (Fig. 2)

The measured variable M is stepped down to a voltage between -300 and 300 mV in the input stage (1). The input stage includes potential dividers and shunts for this purpose. A constant reference current facilitates the measurement of resistance. Depending on the type of measurement, either one or more of the terminals 1, 2, 6, 7 and 12 and the common ground terminal 11 are used.

The constant reference current which is needed to convert a variation of resistance such as that of a resistance thermometer, remote sensor or potentiometer to a voltage signal is available at terminal 6. The internal current source (2) automatically sets the reference current to either 60 or 380 μA to suit the measuring range. The corresponding signal is applied to terminal 1 and is used for resistance measurement.

Terminal 2 is used for "active" sensors, i.e. thermocouples or other mV generators which inject a voltage between -300 and 300 mV. Small currents from the open-circuit sensor supervision (3) are superimposed on the signals at terminals 1 and 2 in order to monitor the continuity of the measurement circuit. Terminal 2 is also connected to the cold junction compensation element which is a Ni 100 resistor built into the terminal block.

Terminals 7 and 12 are also input terminals and are used for measuring currents and for voltages which exceed ± 300 mV.

An extremely important component of the input stage is the EMC filter which protects the transmitter from interference or even destruction due to induced electromagnetic waves.

From the input stage, the measured variable (e.g. the voltage of a thermocouple) and the two auxiliary signals (cold junction compensation and the open-circuit sensor supervision) go to the multiplexer (4), which controlled by the micro-controller (6) applies them cyclically to the A/D converter (5).

The A/D converter operates according to the dual slope principle with an integration time of 20 ms at 50 Hz and a conversion time of approximately 38 ms per cycle. The internal resolution is 12 Bit regardless of measuring range.

The micro-controller relates the measured variable to the auxiliary signals and to the data which were loaded in the micro-controller's EEPROM via the programming connector (7) when the transmitter was configured. These settings determine the type of measured variable, the measuring range, the transmission mode (e.g. linearised temperature/thermocouple voltage relationship) and the operating sense (output signal directly or inversely proportional to the measured variable). The measured signal is then filtered again, but this time digitally to achieve the maximum possible immunity to interference. Finally the value of the measured variable for the output signal is computed. Apart from nominal operation, the programming connector is also used to transfer measured variables on-line from the transmitter to the PC or vice versa. This is especially useful during commissioning and maintenance.

Depending on the measured variable and the input circuit, it can take 0.4 to 1.1 seconds before a valid signal arrives at the opto-coupler (8). The different processing times result from the fact that, for example, a temperature measurement with a four-wire resistance thermometer and open-circuit sensor supervision requires more measuring cycles than the straight forward measurement of a low voltage.

The main purpose of the opto-coupler is to provide electrical insulation between input and output. On the output side of the opto-coupler, the D/A converter (9) transforms the digital signal back to an analog signal which is then amplified in the output stage (10) and split into two non-electrically isolated output channels. A powerful heavy-duty output is available at A1 and a less powerful output for a field display unit at A2. By a combination of programming and setting the 8 DIP switches in the output stage, the signals at A1 and A2 can be configured to be either a DC current or DC voltage (but both must be either one or the other). The signal A1 is available at terminals 9 and 4 and A2 at terminals 8 and 3.

If the micro-controller (6) detects an open-circuit measurement sensor, it firstly sets the two output signals A1 and A2 to a constant value. The latter can be programmed to adopt a preset value between -10 and 110% or to maintain the value it had at the instant the open-circuit was detected. In this state, the micro-controller also switches on the red LED (11) and causes the green LED (12) to flash. Via the opto-coupler (8), it also excites the relay driver (13) which depending on configuration switches the relay (14) to its energised or de-energised state. The output contact is available at terminals 13, 14 and 15. It is used by safety circuits. In addition to being able to program the relay to be either energised or de-energised, it can also be set to "relay disabled". In this case, an open-circuit sensor is only signalled by the output signal being held constant, the red LED being switched on and the green LED flashing. The relay can also be configured to monitor the measured variable in relation to a programmable limit.

SINEAX V 604

Programmable Universal Transmitter

The normal state of the transmitter is signalled when the green LED (12) is continuously lit. As explained above, it flashes should the measurement sensor become open-circuit. It also flashes, however, if the measured variable falls 10% below the start of the measuring range or rises 10% above its maximum value and during the first five seconds after the transmitter is switched on.

The push-button S1 is for automatically calibrating the leads of a two-wire resistance thermometer circuit. This is done by temporarily shorting the resistance sensor and pressing the button for at least three seconds. The lead resistance is then automatically measured and taken into account when evaluating the measured variable.

The power supply H is connected to terminals 5 and 10 on the input block (15). The polarity is of no consequence, because the input voltage is chopped on the primary side of the power block (16) before being applied to a full-wave rectifier. Apart from the terminals, the input block (15) also contains an EMC filter which suppresses any electromagnetic interference superimposed on the power supply. The transformer block (17) provides the electrical insulation between the power supply and the other circuits and also derives two secondary voltages. One of these (5 V) is rectified and stabilised in (18) and then supplies the electronic circuits on the input side of the transmitter. The other AC from block (17) (- 16 V / + 18 V) is rectified in (19) and used to supply the relay driver and the other components on the output side of the transmitter.

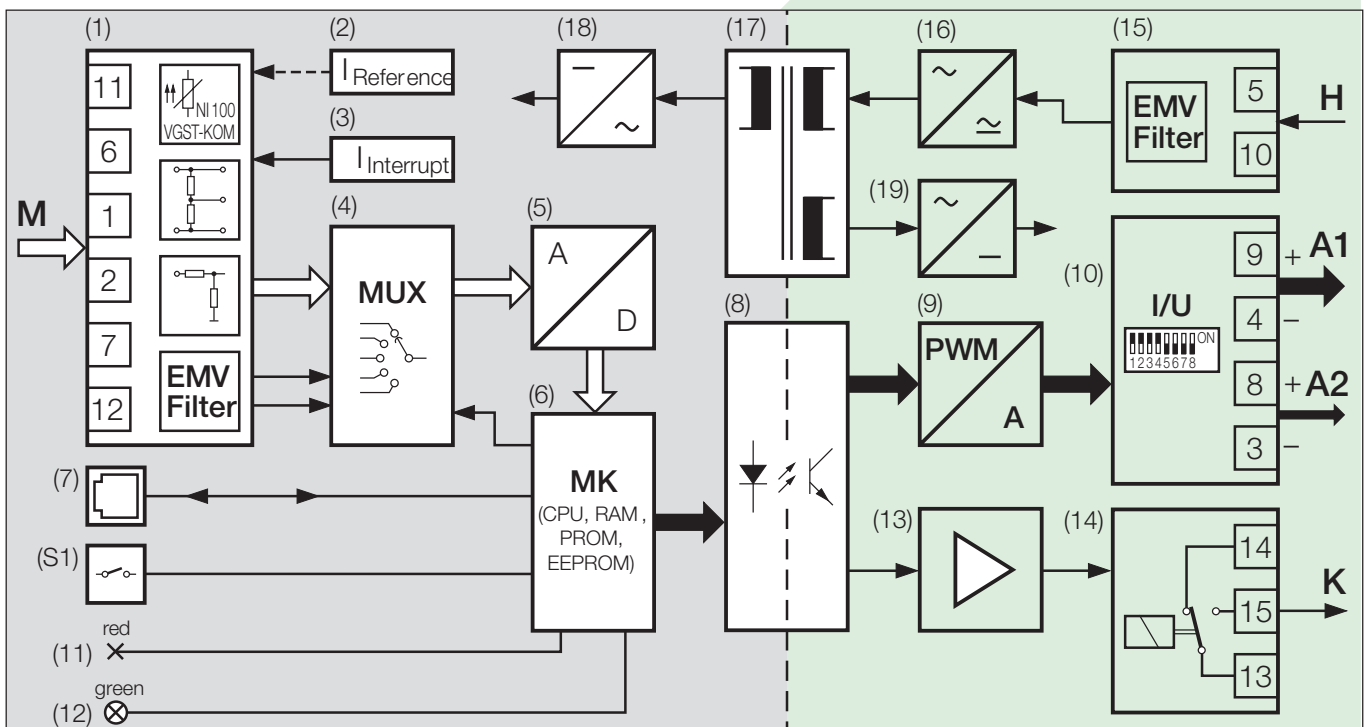

Fig. 2. Block diagram. In the case of the "intrinsically safe" version [EEx ia] IIC, the intrinsically safe circuits are those in the shaded area.

SINEAX V 604

Programmable Universal Transmitter

Programming (Figs. 3 and 4)

A PC with RS 232 C interface (Windows 3.1x, 95, 98, NT or 2000), the programming cable PRKAB 600 and the configuration software VC 600 are required to program the transmitter. (Details of the programming cable and the software are to be found in the separate data sheet: PRKAB 600 Le.)

The connections between "PC ↔ PRKAB 600 ↔ SINEAX V 604" can be seen from Fig. 4. The power supply must be applied to SINEAX V 604 before it can be programmed.

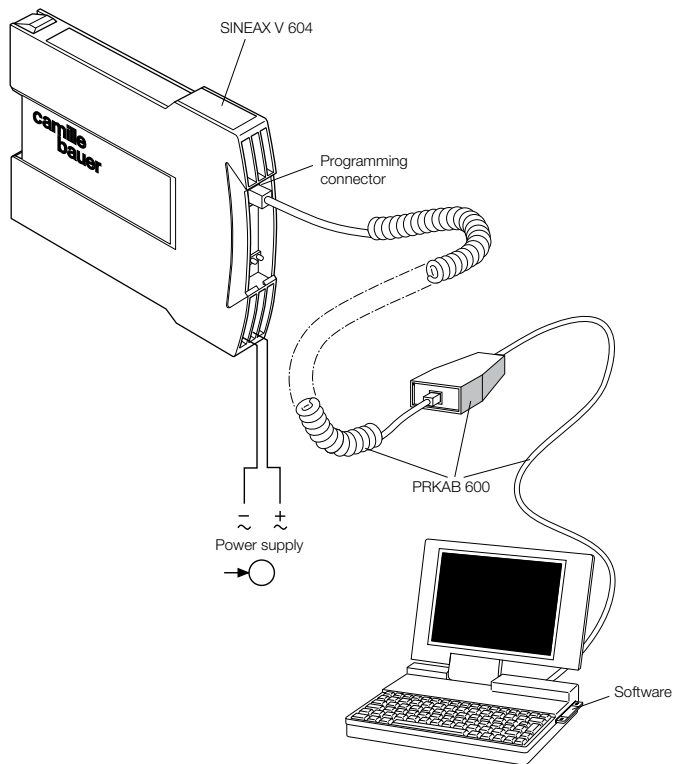

Fig. 3

The software VC 600 is supplied on a CD.

The programming cable PRKAB 600 adjusts the signal level and provides the electrical insulation between the PC and SINEAX V 604.

The programming cable PRKAB 600 is used for programming both standard and Ex versions.

Of the programmable details listed in section "Features / Benefits" **one** parameter – the **output signal** – has to be determined by PC programming as well as mechanical setting on the transmitter unit ...

... the output signal **range by PC**

... the **type** of output (current or voltage signal) has to be set **by DIP switch** (see Fig. 4).

The eight pole DIP switch is located on the PCB in the SINEAX V 604.

DIP switches	Type of output signal
	load-independent current
	load-independent voltage

Fig. 4

Technical data

Measuring input \rightarrow

Measured variable M

The measured variable M and the measuring range can be programmed

Table 1: Measured variables and measuring ranges

Measured variables	Measuring ranges		
	Limits	Min. span	Max. span
DC voltages			
direct input	$\pm 300 \text{ mV}^1$	2 mV	300 mV
via potential divider ²	$\pm 40 \text{ V}^1$	300 mV	40 V
DC currents			
low current range	$\pm 12 \text{ mA}^1$	0.08 mA	12 mA
high current range	- 50 to + 100 mA ¹	0.75 mA	100 mA
Temperature monitored by two, three or four-wire resistance thermometers	- 200 to 850 °C		
low resistance range	0...740 Ω^1	8 Ω	740 Ω
high resistance range	0...5000 Ω^1	40 Ω	5000 Ω
Temperature monitored by thermocouples	- 270 to 1820 °C	2 mV	300 mV
Variation of resistance of remote sensors / potentiometers			
low resistance range	0...740 Ω^1	8 Ω	740 Ω
high resistance range	0...5000 Ω^1	40 Ω	5000 Ω

¹ Note permissible value of the ratio "full-scale value/span ≤ 20 ".

² Max. 30 V for Ex version with I.S. measuring input.

SINEAX V 604

Programmable Universal Transmitter

DC voltage		Differential circuit:	2 identical three-wire resistance thermometers for deriving the mean temperature RT1–RT2 wiring diagram No. 7 ¹
Measuring range:	See Table 1	Input resistance:	$R_i > 10 \text{ M}\Omega$
Direct input:	Wiring diagram No. 1 ¹	Lead resistance:	$\leq 30 \text{ }\Omega$ per lead
Input resistance:	$R_i > 10 \text{ M}\Omega$ Continuous overload max. $-1.5 \text{ V}, +5 \text{ V}$	Thermocouples	
Input via potential divider:	Wiring diagram No. 2 ¹	Measuring range:	See Tables 1 and 8
Input resistance:	$R_i = 1 \text{ M}\Omega$ Continuous overload max. $\pm 100 \text{ V}$	Thermocouple pairs:	Type B: Pt30Rh-Pt6Rh (IEC 584) Type E: NiCr-CuNi (IEC 584) Type J: Fe-CuNi (IEC 584) Type K: NiCr-Ni (IEC 584) Type L: Fe-CuNi (DIN43710) Type N: NiCrSi-NiSi (IEC 584) Type R: Pt13Rh-Pt (IEC 584) Type S: Pt10Rh-Pt (IEC 584) Type T: Cu-CuNi (IEC 584) Type U: Cu-CuNi (DIN43710) Type W5-W26 Re Other thermocouple pairs on request
DC current		Standard circuit:	1 thermocouple, internal cold junction compensation, wiring diagram No. 8 ¹ 1 thermocouple, external cold junction compensation, wiring diagram No. 9 ¹
Measuring range:	See Table 1	Summation circuit:	2 or more thermocouples in a summation circuit for deriving the mean temperature, external cold junction compensation, wiring diagram No. 10 ¹
Low currents:	Wiring diagram No. 3 ¹	Differential circuit:	2 identical thermocouples in a differential circuit for deriving the mean temperature TC1 – TC2, no provision for cold junction compensation, wiring diagram No. 11 ¹
Input resistance:	$R_i = 24.7 \text{ }\Omega$ Continuous overload max. 150 mA	Input resistance:	$R_i > 10 \text{ M}\Omega$
High currents:	Wiring diagram No. 3 ¹	Cold junction compensation:	
Input resistance:	$R_i = 24.7 \text{ }\Omega$ Continuous overload max. 150 mA	Internal:	Incorporated Ni 100
Resistance thermometer		Permissible variation of the internal cold junction compensation:	$\pm 0.5 \text{ K}$ at $23 \text{ }^\circ\text{C}$, $\pm 0.25 \text{ K}/10 \text{ K}$
Measuring range:	See Tables 1 and 8	External:	$0 \dots 70 \text{ }^\circ\text{C}$, programmable
Resistance types:	Type Pt 100 (DIN IEC 751) Type Ni 100 (DIN 43 760) Type Pt 20/20 $^\circ\text{C}$ Type Cu 10/25 $^\circ\text{C}$ Type Cu 20/25 $^\circ\text{C}$ See "Table 6: Specification and ordering information", feature 6 for other Pt or Ni.		
Measuring current:	$\leq 0.38 \text{ mA}$ for measuring ranges $0 \dots 740 \text{ }\Omega$ or $\leq 0.06 \text{ mA}$ for measuring ranges $0 \dots 5000 \text{ }\Omega$		
Standard circuit:	1 resistance thermometer: – two-wire connection, wiring diagram No. 4 ¹ – three-wire connection, wiring diagram No. 5 ¹ – four-wire connection, wiring diagram No. 6 ¹		
Summation circuit:	Series of parallel connection of 2 or more two, three or four-wire resistance thermometers for deriving the mean temperature or for matching other types of sensors, wiring diagram No. 4 - 6 ¹		

¹ See "Table 9: Measuring input".

SINEAX V 604

Programmable Universal Transmitter

Resistance sensor, potentiometer

Measuring range:	See Table 1
Resistance sensor types:	Type WF Type WF DIN Potentiometer see "Table 6: Specification and ordering information" feature 5.
Measuring current:	≤ 0.38 mA for measuring range 0...740 Ω or ≤ 0.06 mA for measuring range 0...5000 Ω
Kinds of input:	1 resistance sensor WF current measured at pick-up, wiring diagram No. 12 ¹ 1 resistance sensor WF DIN current measured at pick-up, wiring diagram No. 13 ¹ 1 resistance sensor for two, three or four-wire connection, wiring diagram No. 4-6 ¹ 2 identical three-wire resistance sensors for deriving a differential, wiring diagram No. 7 ¹
Input resistance:	$R_i > 10$ M Ω
Lead resistance:	≤ 30 Ω per lead

Output signal \rightarrow

Output signals A1 and A2

The output signals available at A1 and A2 can be configured for either an impressed DC current I_A or a superimposed DC voltage U_A by appropriately setting DIP switches. The desired range is programmed using a PC. A1 and A2 are not DC isolated and exhibit the same value.

Standard ranges for I_A :	0...20 mA or 4...20 mA
Non-standard ranges:	Limits -22 to + 22 mA Min. span 5 mA Max. span 40 mA
Open-circuit voltage:	Neg. -13.2...-18 V, pos. 16.5...21 V
Burden voltage I_{A1} :	+ 15 V, resp. -12 V
External resistance I_{A1} :	$R_{\text{ext max.}} [\text{k}\Omega] = \frac{15 \text{ V}}{I_{\text{AN}} [\text{mA}]}$ resp. $= \frac{-12 \text{ V}}{I_{\text{AN}} [\text{mA}]}$ I_{AN} = full-scale output current
Burden voltage I_{A2} :	< 0.3 V

External resistance I_{A2} :	$R_{\text{ext max.}} [\text{k}\Omega] = \frac{0.3 \text{ V}}{I_{\text{AN}} [\text{mA}]}$
Residual ripple:	$< 1\%$ p.p., DC ... 10 kHz $< 1.5\%$ p.p. for an output span < 10 mA
Standard ranges for U_A :	0...5, 1...5, 0...10 or 2...10 V
Non-standard ranges:	Limits -12 to + 15 V Min. span 4 V Max. span 27 V
Open-circuit voltage:	≤ 40 mA
Load capacity U_{A1} / U_{A2} :	20 mA
External resistance U_{A1} / U_{A2} :	$R_{\text{ext}} [\text{k}\Omega] \geq \frac{U_A [\text{V}]}{20 \text{ mA}}$
Residual ripple:	$< 1\%$ p.p., DC ... 10 kHz $< 1.5\%$ p.p. for an output span < 8 V

Fixed settings for the output signals A1 and A2

After switching on: A1 and A2 are at a fixed value for 5 s after switching on (default). Setting range -10 to 110%² programmable, e.g. between 2.4 and 21.6 mA (for a scale of 4 to 20 mA). The green LED ON flashes for the 5 s

When input variable out of limits: A1 and A2 are at either a lower or an upper fixed value when the input variable ...

... falls more than 10% below the minimum value of the permissible range

... exceeds the maximum value of the permissible range by more than 10%.

Lower fixed value = -10%², e.g. -2 mA (for a scale of 0 to 20 mA).

Upper fixed value = 110%², z.B. 22 mA (for a scale of 0 to 20 mA).

The green LED ON flashes

Open-circuit sensor: A1 and A2 are at a fixed value when an open-circuit sensor is detected (see Section "Sensor and open-circuit lead supervision \rightarrow ").

The fixed value of A1 and A2 is configured to either maintain their values at the instant the open-circuit occurs or adopt a preset value between -10 and 110%², e.g. between 1.2 and 10.8 V (for a scale of 2 to 10 V).

The green LED ON flashes and the red LED \rightarrow lights continuously

¹ See "Table 9: Measuring input".

² In relation to analog output span A1 resp. A2.

SINEAX V 604

Programmable Universal Transmitter

Output characteristic

Characteristic: Programmable

Table 2: Available characteristics (acc. to measured variable)

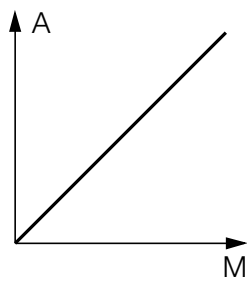
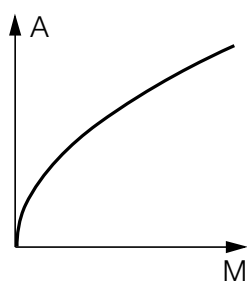
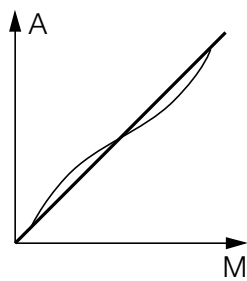
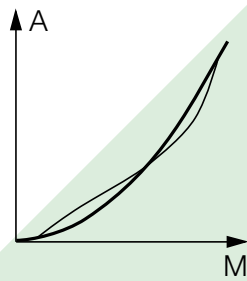
Measured variables	Characteristic
DC voltage	
DC current	
Resistance thermometer (linear variation of resistance)	
Thermocouple (linear variation of voltage)	
Sensor or potentiometer	$A = M$
DC voltage	
DC current	
	$A = \sqrt{M}$ or $A = \sqrt{M^3}$
DC voltage	
DC current	
Resistance thermometer (linear variation with temperature)	
Thermocouple signal (linear variation with temperature)	
Sensor or potentiometer	
	$A = f(M)^1$ linearised
DC voltage	
DC current	
Sensor or potentiometer	
	$A = f(M)^2$ quadratic

Special characteristics

Power supply H → ○

DC, AC power pack (DC and 45...400 Hz)

Table 3: Nominal voltage and tolerance

Nominal voltage U_N	Tolerance	Instrument version
24 ... 60 V DC/AC	DC - 15...+ 33% AC ± 15%	Standard (Non-Ex)
85 ... 230 V ³ DC/AC		
24 ... 60 V DC/AC	DC - 15...+ 33% AC ± 15%	Type of protection "Intrinsic safety" [Ex ia] IIC
85 ... 230 V AC	± 10%	
85 ... 110 V DC	- 15...+ 10%	

Power consumption: ≤ 1.4 W resp. ≤ 2.7 VA

Open-circuit sensor circuit supervision ↗

Resistance thermometers, thermocouples, remote sensors and potentiometer input circuits are supervised. The circuits of DC voltage and current inputs are not supervised.

Pick-up/reset level: 1 to 15 kΩ acc. to kind of measurement and range

Signalling modes

Output signals
A1 and A2:

Programmable fixed values.
The fixed value of A1 and A2 is configured to either maintain their values at the instant the open-circuit occurs or adopt a preset value between - 10 and 110%⁴, e.g. between 1.2 and 10.8 V (for a scale of 2 to 10 V)

Frontplate signals:

The green LED ON flashes and the red LED ↗ lights continuously

Output contact K:

Relay 1 potentially-free changeover contact (see Table 4)
Operating sense programmable.
The relay can be either energised or de-energised in the case of a disturbance.
Set to "Relay inactive" if not required!

¹ 25 input points M given referred to a linear output scale from -10% to + 110% in steps of 5%.

² 25 input points M given referred to a quadratic output scale from -10% to + 110%. Pre-defined output points: 0, 0, 0, 0.25, 1, 2.25, 4.00, 6.25, 9.00, 12.25, 16.00, 20.25, 25.00, 30.25, 36.00, 42.25, 49.00, 56.25, 64.00, 72.25, 81.00, 90.25, 100.0, 110.0, 110.0%.

³ An external supply fuse must be provided for DC supply voltages > 125 V.

⁴ In relation to analog output span A1 resp. A2.

SINEAX V 604

Programmable Universal Transmitter

Supervising a limit GW (Δ)

This Section only applies to transmitters which are **not** configured to use the output contact K in conjunction with the open-circuit sensor supervision (see Section "Open-circuit sensor circuit supervision \rightarrow »).

This applies ...

... in all cases when the measured variable is a DC voltage or current

... when the measured variable is a resistance thermometer, a thermocouple, a remote sensor or a potentiometer and the relay is set to "Relay disabled"

Limit: Programmable

- Disabled
- Lower limit value of the measured variable (see Fig. 5, left)
- Upper limit value of the measured variable (see Fig. 5, left)
- Maximum rate of charge of the measured variable

$$\text{Slope} = \frac{\Delta \text{ measured variable}}{\Delta t}$$

(see Fig. 5 right)

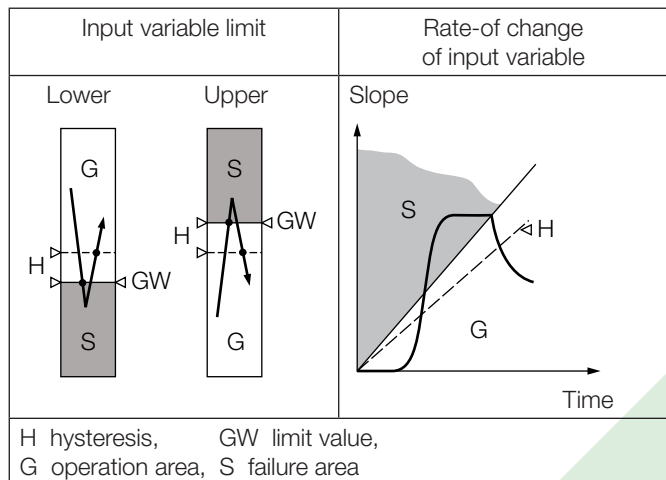

Fig. 5. Switching function according to limit monitored.

Trip point setting using PC for GW:

Programmable

- between -10 and 110%¹ (of the measured variable)
- between ± 1 and $\pm 50\%$ ¹/s (of the rate-of-change of the measured variable)

Reset ratio:

Programmable

- between 0.5 and 100%¹ (of the measured variable)
- between 1 and 100%¹/s (of the rate-of-change of the measured variable)

¹ In relation to analog output span A1 resp. A2.

Operating and resetting delays:

Programmable
- between 1 to 60 s

Operating sense:

Programmable
- Relay energized, LED on
- Relay energized, LED off
- Relay de-energized, LED on
- Relay de-energized, LED off (once limit reached)

Relay status signal:

GW by red LED (Δ)

Table 4: Contact arrangement and data

Symbol	Material	Contact rating
	Gold flashed silver alloy	AC: $\leq 2 \text{ A}/250 \text{ V}$ (500 VA) DC: $\leq 1 \text{ A}/0.01 \dots 250 \text{ V}$ (30 W)

Relay approved by UL, CSA, TÜV, SEV

Programming connector

Interface: RS 232 C

FCC-68 socket: 6/6 pin

Signal level: TTL (0/5 V)

Power consumption: Approx. 50 mW

Accuracy data (acc. to DIN/IEC 770)

Basic accuracy: Max. error $\leq \pm 0.2\%$
Including linearity and repeatability errors for current, voltage and resistance measurement

Additional error (additive): $< \pm 0.3\%$ for linearised characteristic

$< \pm 0.3\%$ for measuring ranges
 $< 5 \text{ mV}$, $0.3 \dots 0.75 \text{ V}$,
 $< 0.2 \text{ mA}$ or $< 20 \Omega$

$< \pm 0.3\%$ for a high ratio between full-scale value and measuring range

$> \text{factor } 10$,
e.g. Pt 100
 $175.84 \Omega \dots 194.07 \Omega$
 $\geq 200 \text{ }^\circ\text{C} \dots 250 \text{ }^\circ\text{C}$

$< \pm 0.3\%$ for current output
 $< 10 \text{ mA}$ span

$< \pm 0.3\%$ for voltage output
 $< 8 \text{ V}$ span

$< 2 \cdot$ (basic and additional error) for two-wire resistance measurement

Reference conditions:

Ambient temperature $23 \text{ }^\circ\text{C}$, $\pm 2 \text{ K}$

Power supply $24 \text{ V DC} \pm 10\%$ and
 $230 \text{ V AC} \pm 10\%$

SINEAX V 604

Programmable Universal Transmitter

Output burden	Current: $0.5 \cdot R_{ext}$ max. Voltage: $2 \cdot R_{ext}$ min.	Standards	
Influencing factors:		Electromagnetic compatibility:	The standards DIN EN 50 081-2 and DIN EN 50 082-2 are observed
Temperature	$< \pm 0.1 \dots 0.15\%$ per 10 K	Intrinsically safe:	Acc. to DIN EN 50 020: 1996-04
Burden	$< \pm 0.1\%$ for current output $< 0.2\%$ for voltage output, providing $R_{ext} > 2 \cdot R_{ext}$ min.	Protection (acc. to IEC 529 resp. EN 60 529):	Housing IP 40 Terminals IP 20
Long-time drift	$< \pm 0.3\%$ / 12 months	Electrical design:	Acc. to IEC 1010 resp. EN 61 010
Switch-on drift	$< \pm 0.5\%$	Operating voltages:	Measuring input < 40 V Programming connector, measuring outputs < 25 V Output contacts, power supply < 250 V
Common and transverse mode influence	$< \pm 0.2\%$	Rated insulation voltages:	Measuring input, programming connector, measuring outputs, output contact, power supply < 250 V
+ or – output connected to ground:	$< \pm 0.2\%$	Pollution degree:	2
Installation data		Installation category II:	Measuring input, programming connector, measuring output, output contact
Housing:	Housing type S17 Refer to Section “Dimensional drawings” for dimensions	Installation category III:	Power supply
Material of housing:	Lexan 940 (polycarbonate) Flammability Class V-0 acc. to UL 94, self-extinguishing, non-dripping, free of halogen	Test voltage:	Measuring input and programming connector to: – Measuring outputs 2.3 kV, 50 Hz, 1 min. – Power supply 3.7 kV, 50 Hz, 1 min. – Output contact 2.3 kV, 50 Hz, 1 min.
Mounting:	For snapping onto top-hat rail (35 x 15 mm or 35 x 7.5 mm) acc. to EN 50 022 or directly onto a wall or panel using the pull-out screw hole brackets	Measuring outputs to:	– Power supply 3.7 kV, 50 Hz, 1 min. – Output contact 2.3 kV, 50 Hz, 1 min.
Mounting position:	Any	Serial interface for the PC to:	– everything else 4 kV, 50 Hz, 1 min. (PRKAB 600)
Terminals:	DIN/VDE 0609 Screw terminals with wire guards for light PVC wiring and max. 2×0.75 mm ² or $1 \times 2,5$ mm ²		
Permissible vibrations:	2 g acc. to EN 60 068-2-6 10 ... 150 ... 10 Hz, 10 cycles		
Choc:	3×50 g 3 shocks each in 6 directions acc. to EN 60 068-2-27		
Weight:	Approx. 0.25 kg	Ambient conditions	
Electrical insulation:	All circuits (measuring input / measuring outputs / power supply / output contact) are electrically insulated. Programming connector and measuring input are connected. The PC is electrically insulated by the programming cable PRKAB 600.	Commissioning temperature:	– 10 to + 55 °C
		Operating temperature:	–25 to + 55 °C, Ex –20 to + 55 °C
		Storage temperature:	– 40 to + 70 °C
		Relative humidity annual mean:	$\leq 75\%$ standard climatic rating $\leq 95\%$ enhanced climatic rating

SINEAX V 604

Programmable Universal Transmitter

Basic configuration

The transmitter SINEAX V 604 is also available already programmed with a **basic** configuration which is especially recommended in cases where the programming data is not known at the time of ordering (see "Table 6: Specification and ordering information" feature 4.).

SINEAX V 604 supplied as standard versions are programmed for **basic** configuration (see "Table 5: Standard versions").

Basic configuration:

Measuring input 0...5 V DC
 Measuring output 0...20 mA linear,
 fixed value 0%
 during 5 s after switching on
 Setting time 0.7 s
 Open-circuit supervision inactive
 Mains ripple suppression 50 Hz
 Limit functions inactive

Table 5: Standard versions

The following 4 transmitter versions are already programmed for **basic** configuration and are available as standard versions. It is only necessary to quote the **Order No.**:

Cold junction compensation	Climatic rating	Instrument	Power supply	Order Code ¹	Order No.
included	standard	Standard version	24 ... 60 V DC/AC	604-1120	973 059
			85 ... 230 V DC/AC	604-1220	973 083
		[EEx ia] IIC version, measuring circuit I.S.	24 ... 60 V DC/AC	604-1320	973 116
			85 ... 110 V DC/ 85 ... 230 V AC	604-1420	973 140

The complete Order Code¹ 604-...0 and/or a description should be stated for other versions with the basic works configuration.

Table 6: Specification and ordering information (see also "Table 5: Standard versions")

Description	*Blocking code	no-go with blocking code	Article No./ Feature
SINEAX V 604	Order Code V 604 - xxxx xxxx xxxx x		604 –
Features, Selection			
1. Mechanical design Housing S17			1
2. Version / Power supply H (nominal voltage U_N)			
Standard / 24 ... 60 V DC/AC			1
Standard / 85 ... 230 V DC/AC			2
[EEx ia] IIC / 24 ... 60 V DC/AC			3
[EEx ia] IIC / 85 ... 110 V DC, 85 ... 230 V AC			4
Lines 3 and 4: Instrument [EEx ia] IIC, measuring circuit EEx ia IIC			
3. Climatic rating / Cold junction compensation			
Standard climatic rating; instrument with cold junction compensation			2
Extra climatic rating; instrument with cold junction compensation			4
4. Configuration			
Basic configuration, programmed (no test certificate) If you wish to order the basic configuration, the line "0" must be selected for options 4. to 13., i.e. all the digits of the order code after the 4th, are zeros, see "Table 5: Standard versions"!	Z		0
Programmed to order (no test certificate)			1
Programmed to order with test certificate			2

¹ See "Table 6: Specification and ordering information".

SINEAX V 604

Programmable Universal Transmitter

Description	*Blocking code	no-go with blocking code	Article No./ Feature
SINEAX V 604 Order Code V 604 - xxxx xxxx xxxx x			604 –
Features, Selection			
5. Measured variable / Measuring input M			
DC voltage			
0 ... 5 V linear	C		0
1 ... 5 V linear	C	Z	1
0 ... 10 V linear	C	Z	2
2 ... 10 V linear	C	Z	3
Linear input, other ranges [V]	C	Z	4
Square root input function [V]	C	Z	5
Input x 3/2 [V]	C	Z	6
Lines 4 to 6: DC [V] 0...0.002 to 0...≤ 40 V (Ex max. 30 V) or span 0.002 to 40 V between – 40 and 40 V, ratio full-scale/span ≤ 20			
DC current			
0 ... 20 mA linear	C	Z	7
4 ... 20 mA linear	C	Z	8
Linear input, other ranges [mA]	C	Z	9
Square root input function [mA]	C	Z	A
Input x 3/2 [mA]	C	Z	B
Lines 9, A and B: DC [mA] 0...0.08 to 0...100 mA or span 0.08 to 100 mA between – 50 and 100 mA, ratio full-scale/span ≤ 20			
Resistance thermometer, linearised			
Two-wire connection, R_L [Ω]	E	Z	C
Three-wire connection, $R_L \leq 30 \Omega$ /wire	E	Z	D
Four-wire connection, $R_L \leq 30 \Omega$ /wire	E	Z	E
Resistance thermometer, non-linearised			
Two-wire connection, R_L [Ω]	E	Z	F
Three-wire connection, $R_L \leq 30 \Omega$ /wire	E	Z	G
Four-wire connection, $R_L \leq 30 \Omega$ /wire	E	Z	H
Temperature difference [deg]	E	Z	J
2 identical resistance thermometers in three-wire connection Temperature difference; specify measuring range [deg], also for feature 6: t_{min} , t_{max} , $t_{reference}$			
Lines C and F: Specify total lead resistance R_L [Ω], any value between 0 and 60 Ω. This may be omitted, because two leads can be compensated automatically on site..			
Thermocouple linearised			
Internal cold junction compensation (not for type B)	DT	Z	K
External cold junction compensation (specify 0 °C for type B)* tK [°C]	D	Z	L

* Because of its characteristic, thermocouple type B does not require compensating leads nor cold junction compensation.

SINEAX V 604

Programmable Universal Transmitter

Description	*Blocking code	no-go with blocking code	Article No./ Feature
SINEAX V 604	Order Code V 604 - xxxx xxxx xxxx x		604 –
Features, Selection			
6. Sensor type / Temperature range (continuation)			
Type B Pt30Rh-Pt6Rh	[°C]		CEFTZ B
Type E NiCr-CuNi	[°C]		CEFZ E
Type J Fe-CuNi	[°C]		CEFZ J
Type K NiCr-Ni	[°C]		CEFZ K
Type L Fe-CuNi	[°C]		CEFZ L
Type N NiCrSi-NiSi	[°C]		CEFZ N
Type R Pt13Rh-Pt	[°C]		CEFZ R
Type S Pt10Rh-Pt	[°C]		CEFZ S
Type T Cu-CuNi	[°C]		CEFZ T
Type U Cu-CuNi	[°C]		CEFZ U
Type W5-W26Re	[°C]		CEFZ W
Lines B to W; Specify measuring range in [°C] or °F, refer to Table 8 for the operating limits for each type of sensor. For temperature difference measurement: specify measuring range and reference temperature for 2nd sensor (t_{min} ; t_{max} ; $t_{reference}$), e.g. 100; 250; 150.			
7. Output signal / Measuring output A1*			
0 ... 20 mA, $R_{ext} \leq 750 \Omega$			0
4 ... 20 mA, $R_{ext} \leq 750 \Omega$		Z	1
Non-standard (– 22 to + 22, span 5 to 40 mA)	[mA]	Z	2
0 ... 5 V, $R_{ext} \geq 250 \Omega$		Z	3
1 ... 5 V, $R_{ext} \geq 250 \Omega$		Z	4
0 ... 10 V, $R_{ext} \geq 500 \Omega$		Z	5
2 ... 10 V, $R_{ext} \geq 500 \Omega$		Z	6
Non-standard (– 12 to + 15, span 4 to 27 V)	[V]	Z	7
8. Output characteristic			
Directly proportional, initial start-up value 0%			0
Inversely proportional, initial start-up value 100%		Z	1
Directly proportional, initial start-up value	[%]	Z	2
Inversely proportional, initial start-up value	[%]	Z	3
9. Output time response			
Rated setting time approx. 1 s			0
Others (any whole number from 2 to 30 s)	[s]	Z	1

*2nd output signal A2 for field indicator only

SINEAX V 604

Programmable Universal Transmitter

Table 8: Temperature measuring range

Measuring range [°C]	Resistance thermometer		Thermocouple									
	Pt100	Ni100	B	E	J	K	L	N	R	S	T	U
0 ... 20												
0 ... 25	X	X										
0 ... 40	X	X		X	X		X					
0 ... 50	X	X		X	X	X	X				X	X
0 ... 60	X	X		X	X	X	X				X	X
0 ... 80	X	X		X	X	X	X				X	X
0 ... 100	X	X		X	X	X	X	X			X	X
0 ... 120	X	X		X	X	X	X	X			X	X
0 ... 150	X	X		X	X	X	X	X			X	X
0 ... 200	X	X		X	X	X	X	X			X	X
0 ... 250	X	X		X	X	X	X	X			X	X
0 ... 300	X			X	X	X	X	X	X	X	X	X
0 ... 400	X			X	X	X	X	X	X	X	X	X
0 ... 500	X			X	X	X	X	X	X	X		X
0 ... 600	X			X	X	X	X	X	X	X		X
0 ... 800			X									
0 ... 900			X	X	X	X	X	X	X	X		
0 ... 1000			X	X	X	X		X	X	X		
0 ... 1200			X		X	X		X	X	X		
0 ... 1500			X						X	X		
0 ... 1600			X						X	X		
50 ... 150	X	X		X	X	X	X	X			X	X
100 ... 300	X			X	X	X	X	X			X	X
300 ... 600	X			X	X	X	X	X	X	X		X
600 ... 900			X	X	X	X	X	X	X	X		
600 ... 1000			X	X	X	X		X	X	X		
900 ... 1200			X		X	X		X	X	X		
600 ... 1600			X						X	X		
600 ... 1800			X									
-20 ... 20	X	X		X	X		X					
-10 ... 40	X	X		X	X	X	X					X
-30 ... 60	X	X		X	X	X	X	X			X	X
Measuring range limits [°C]	-200 to 850	-60 to 250	0 to 1820	-270 to 1000	-210 to 1200	-270 to 1372	-200 to 900	-270 to 1300	-50 to 1769	-50 to 1769	-270 to 400	-200 to 600
	ΔR min 8 Ω at full-scale $\leq 740 \Omega$ ΔR min 40 Ω at full-scale $> 740 \Omega$ to 5000 Ω		ΔU min 2 mV									

SINEAX V 604

Programmable Universal Transmitter

Electrical connections

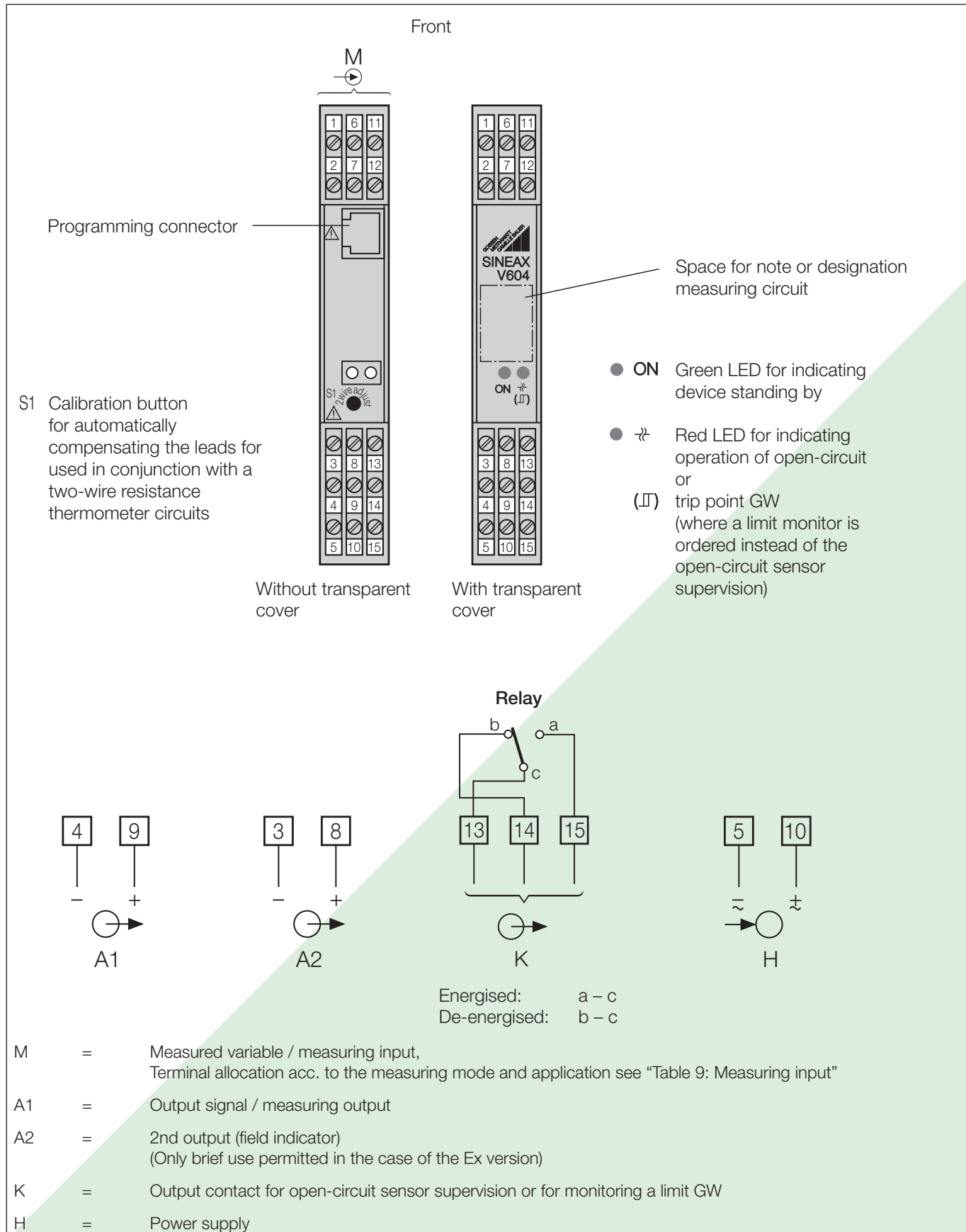

SINEAX V 604

Programmable Universal Transmitter

Table 9: Measuring input

Measurement	Measuring range limits	Measuring span	No.	Wiring diagram Terminal arrangement
DC voltage (direct input)	- 300...0...300 mV	2...300 mV	1	
DC voltage (input via potential divider)	- 40...0...40 V	0.3...40 V	2	
DC current	- 12...0... 12 mA/ - 50...0...100 mA	0.08... 12 mA/ 0.75...100 mA	3	
Resistance thermometer RT or resistance measurement R, two-wire connection	0... 740 Ω/ 0...5000 Ω	8... 740 Ω/ 40...5000 Ω	4	
Resistance thermometer RT or resistance measurement R, three-wire connection	0... 740 Ω/ 0...5000 Ω	8... 740 Ω/ 40...5000 Ω	5	
Resistance thermometer RT or resistance measurement R, four-wire connection	0... 740 Ω/ 0...5000 Ω	8... 740 Ω/ 40...5000 Ω	6	
2 identical three-wire resistance transmitters RT for deriving the difference	RT1 - RT2 0... 740 Ω/ 0...5000 Ω	8... 740 Ω/ 40...5000 Ω	7	
Thermocouple TC Cold junction compensation internal (Ni 100)	- 300...0...300 mV	2...300 mV	8	
Thermocouple TC Cold junction compensation external	- 300...0...300 mV	2...300 mV	9	
Thermocouple TC in a summation circuit for deriving the mean temperature	- 300...0...300 mV	2...300 mV	10	
Thermocouple TC in a differential circuit for deriving the mean temperature	TC1 - TC2 - 300...0...300 mV	2...300 mV	11	
Resistance sensor WF	0... 740 Ω/ 0...5000 Ω	8... 740 Ω/ 40...5000 Ω	12	
Resistance sensor WF DIN	0... 740 Ω/ 0...5000 Ω	8... 740 Ω/ 40...5000 Ω	13	

SINEAX V 604

Programmable Universal Transmitter

Dimensional drawings

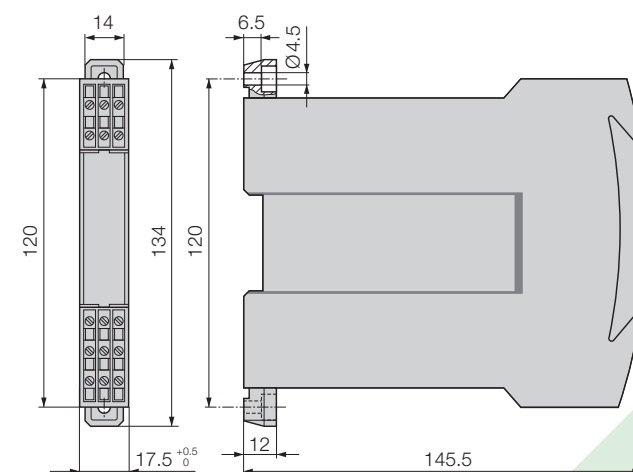
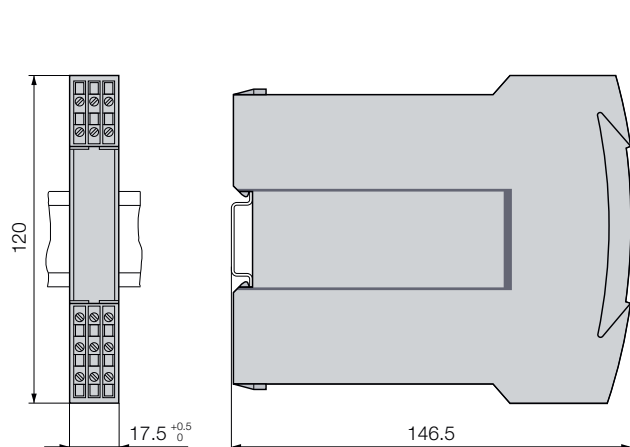

Fig. 6. SINEAX V 604 in housing **S17** clipped onto a top-hat rail (35 × 15 mm or 35 × 7.5 mm, acc. to EN 50 022).

Fig. 7. SINEAX V 604 in housing **S17** with the screw hole brackets pulled out for wall mounting.

Table 10: Accessories and spare parts

Description	Order No.
Programming cable PRKAB 600 for SINEAX/EURAX VC 603/V 604, SIRAX V 644 and SINEAX TV 809	147 787
Ancillary cable for SINEAX/EURAX VC 603/V 604 and SIRAX V 644	988 058
Configuration Software VC 600 for SINEAX/EURAX VC 603/V 604 and SIRAX V 644 Windows 3.1x, 95, 98, NT and 2000 incl. V 600 (version 1.6, DOS) on CD in German, English, French and Dutch (Download free of charge under http://www.camillebauer.com) In addition, the CD contains all configuration programmes presently available for Camille Bauer Products	146 557
Pull-out handle (for removing device from its housing)	988 149
Front label (behind transparent cover)	973 504
Inscription label (green, for recording programmed settings)	120 634
Operating Instructions V 604-1 Bd-f-e	987 810

Standard accessories

- 1 Operating Instructions in three languages: German, French, English
- 2 Pull-out handle (for removing device from its housing)
- 2 Front labels (behind transparent cover)
- 2 Inscription labels (green, for recording programmed settings)
- 1 Type examination certificate (only for "intrinsically safe" explosion-proof devices)

 **CAMILLE BAUER**

Rely on us.

Camille Bauer Ltd
Aargauerstrasse 7
CH-5610 Wohlen / Switzerland
Phone: +41 56 618 21 11
Fax: +41 56 618 35 35
e-mail: info@camillebauer.com
www.camillebauer.com