

# SATRON VT Pressure Transmitter

BPV710  
M2, revision 2  
15.2.2013

**SATRON VT pressure transmitter** belongs to the series V-transmitters. SATRON VT is used for 0-1.4 kPa...0-100 MPa ranges. It is a 2-wire transmitter with HART® standard communication. In pressure measuring applications SATRON VT-transmitters are used for measuring the pressure of clean gases, steam and non-crystallizing liquids. The transmitter's sensor is piezoresistive. The rangeability is 100:1 for types VT6 - VT8.



## TECHNICAL SPECIFICATIONS

### Measuring range and span

See Selection Chart.

$$\pm[0.025+0.01 \times \left(\frac{\text{max. span}}{\text{calibrated span}}\right)]\% \text{ of calibrated span}$$

Other sensing element materials:  
AISI316, SIS 2343.

### Zero and Span adjustment

Zero elevation: Calibrated span is freely selectable on the specified range depending from the desired option. This can be made by using extern control shafts, keyboard (display option), HART®275/375 communicator.

(incl. nonlinearity, hysteresis and repeatability)

**Filling fluid:** Silicone oil or inert oil (VT3 - VT7)

### Long-term stability

±0.1 %/max. span/12 months

**Enclosure class** IP66

### Temperature effect on compensated temperature ranges -20...+80 °C

#### Zero and span shift:

±0.15 % of max. span

**Housing with PLUG connector**, housing type codes **H** and **T**  
Housing: AISI316, Seals: Viton® and NBR

TEST jacks: MS358Sn/PVDF, protected with silicone rubber shield.  
PLUG connector: PA6-GF30 jacket, Silicone rubber seal, AISI316 retaining screw.

**Housing with junction box/terminal strip**, housing type codes **M** and **N**  
Housing: AISI303/316, Seals: Nitrile and Viton®; Nameplates: Polyester

**Connection hose between sensing element and housing :**  
Codes **L** and **K** :

PTFE hose with AISI316 braiding.

### Damping

Time constant is continuously adjustable 0.01 to 60 s.

### Temperature limits

Ambient: -30 to +80 °C

Process: -30 to +120 °C, DIN 16288

-20 to +200 °C, DIN 3852-X

Shipping and storage: -40 to +80 °C.

Operating temperature of display:

0 to +50°C (does not affect operation of the transmitter)

### Mounting position effect (VT3 - VT7)

Zero error < 0.32 kPa, which can be calibrated out.

**VT8:** mounting position has no effect

**Pressure limits** Min. and max. process pressure: See the appended tables.

### Vibration effect (IEC 68-2-6: FC):

±0.1 % of measuring range/

2g/10 to 2000 Hz

4g/10 to 100 Hz

### Volumetric displacement

< 0.5 mm<sup>3</sup>/max. span

### Power supply effect

< ±0.01 of calibrated span per volt

**Output** 2-wire (2W), 4-20 mA, user selectable for linear, square root, inverted signal or the transfer function (16 points) specified by the user

### Insulation test voltage

500 V rms 50 Hz

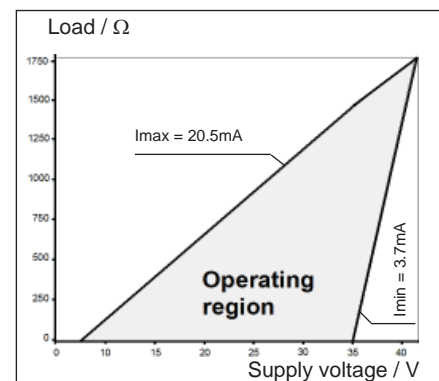

$$R_{\text{max}} = \frac{\text{Supply voltage} - 10V}{I_{\text{max}}}$$

$I_{\text{max}} = 20.5\text{mA}$  using HART®-communication

$I_{\text{max}} = 23\text{mA}$  (when the alarm current 22.5mA is on)

**Supply voltage for transmitter without intrinsic safety (not ATEX)**

### Supply voltage and permissible load

See the load capacity diagram;

4-20 mA output: 12-35 VDC.

### Humidity limits

0-100 % RH; freezing of condensed water not allowed in reference pressure channels.

## PERFORMANCE SPECIFICATIONS

Tested in accordance with IEC 60770: Reference conditions, specified span, no range elevation, horizontal mounting; AISI316L diaphragm, silicone oil fill.

### Accuracy

±0.1 % of calibrated span

(span 1:1-7.5:1 /max.range).

On the measuring ranges 7.5:1-100:1:

## CONSTRUCTION AND CALIBRATION

### Materials

Diaphragm <sup>1)</sup>: AISI316L (EN 1.4435), Duplex (EN 1.4462), Hast. C276 (EN 2.4819), Tantalum or Titanium Gr2 (EN 3.7035).

<sup>1)</sup> Parts in contact with process medium

### Pressure limits

Maximum process pressure, MPa

Transmitter type	Max. overload pressure	Pressure class
VT3	0.2	PN40
VT4	0.3	PN40
VT5	1.5	PN40
VT6	7.5	PN100
VT7	40.0	PN250
VT8	100.0	PN1000

Minimum process pressure (VT8: no min. pressure limitations)

T <sub>proc.</sub> °C	Minimum pressure for different fill fluids (kPa, abs.)	
	DC200 100 cSt	Inert oil
20	5	8
40	8	10
80	16	28
120	21	53

### Calibration

For customer-specified range with 1 s. damping. (If range is not specified, transmitter is calibrated for maximum range.)

### Electrical connections

Housing with PLUG connector, **H** and **T**:  
PLUG connector, connector type DIN 43650 model AF; Pg9 gland for cable; wire cross-section 0.5 to 1.5 mm<sup>2</sup>.

Housing with junction box/terminal strip, **M** and **N**:  
M20x1.5, 1/2-NPT inlet; screw terminals for 0.5 to 2.5 mm<sup>2</sup> wires

### Weight

Transmitter  
- with housing types **H** and **T** : 0,7 kg  
- with housing type **M** and **N** : 1.2 kg

### Product Certifications

#### European Directive Information

#### Electro Magnetic Compatibility (EMC directive 2004/108/EC)

All pressure transmitters

#### Atex Directive (94/9/EC)

Satron Instruments Inc. complies with the ATEX Directive.

#### European Pressure Equipment Directive (PED) (97/23/EC)

All Pressure Transmitters :  
- Sound Engineering Practice

Transmitters with nominal pressure higher than 200 bar fulfil the requirements of the Conformity Assessment procedure Module A of the directive.

### Hazardous Locations Certifications

#### European Certifications

ATEX Intrinsic Safety

Certification No. : DNV-2007-OSL-ATEX- 1346X

 II 1 GD T135°C EEx ia II C T4 -20°C ≤ Tamb ≤ 50°C

 II 2 GD T135°C EEx ia II C T4 -20°C ≤ Tamb ≤ 50°C

#### Input Parameters :

U<sub>i</sub> = 28 V  
I<sub>i</sub> = 93 mA  
P<sub>i</sub> = 0.651 W  
C<sub>i</sub> = 5 nF  
L<sub>i</sub> = 0.2 mH

### Special Conditions for Safe Use (X) :

The enclosure with plastic window and the plastic DIN43650 connector must not be installed in potentially explosive atmosphere requiring category 1 apparatus.

The non-conducting surface of the sensor element may be charged by the flow of non-conducting media, so there may be electrostatic hazard with IIC-gases. These units should be marked 2 GD.

The equipment shall be installed and connected according to the manufacturers instructions.

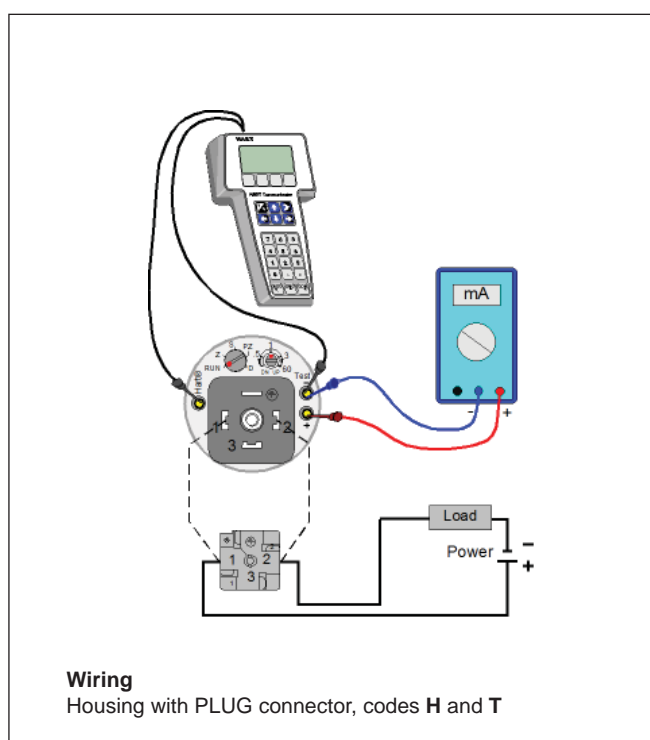
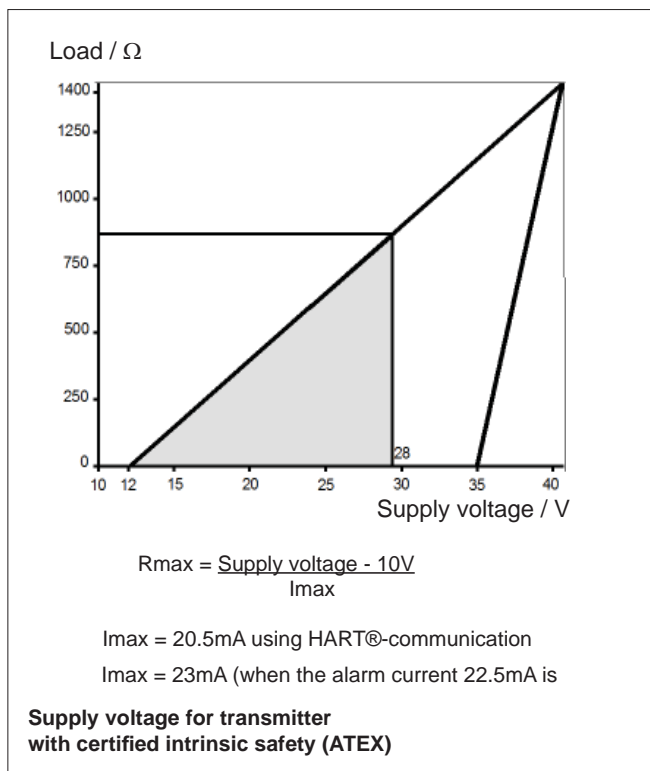

# SATRON VT Pressure Transmitter

BPV710  
15.2.2013

Dimensions ( in mm)

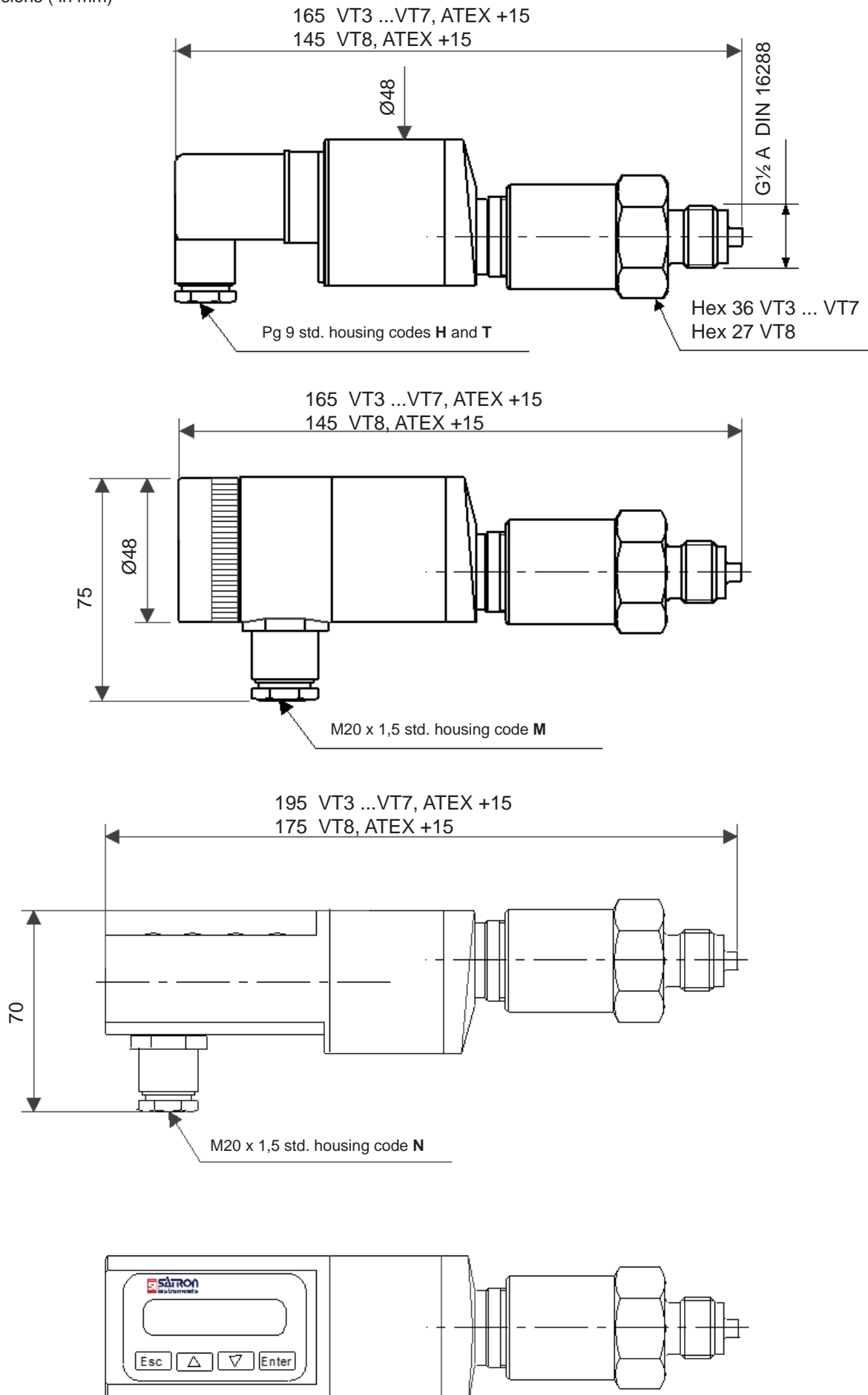

Dimensions ( in mm)

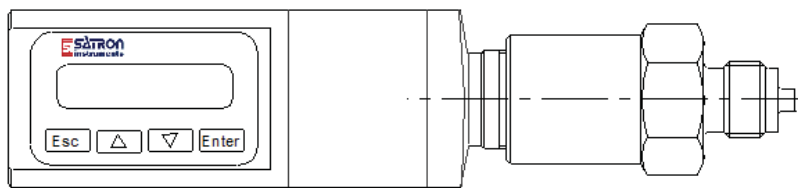
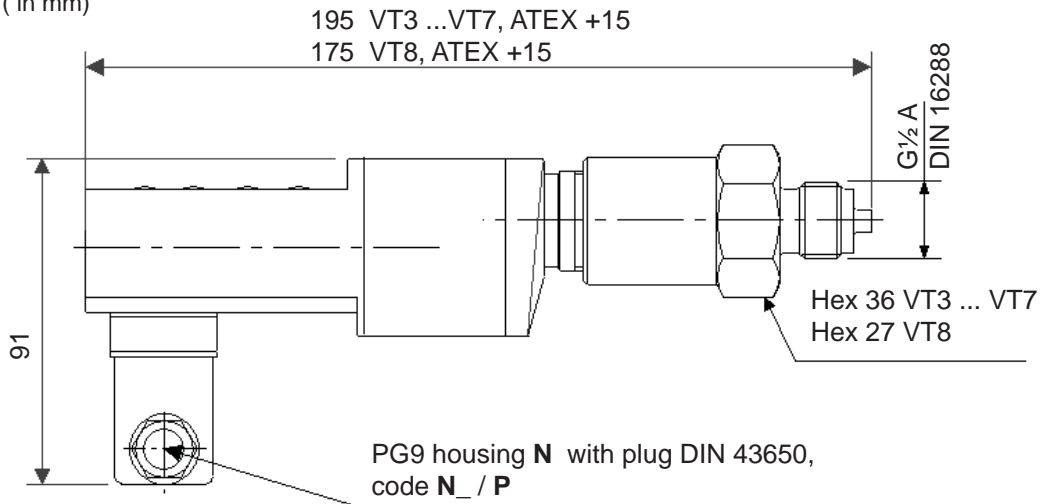

Housing codes H, T and M 195  
Housing code N 225  
Atex transmitter code 1, +15

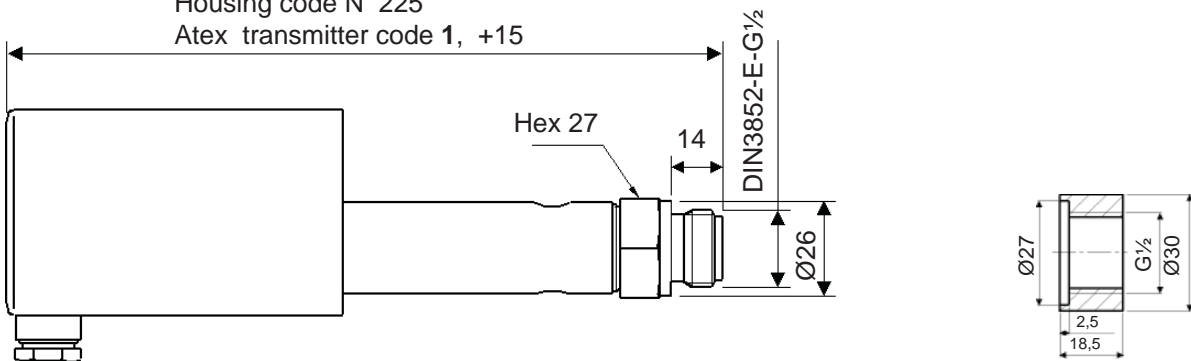

**VT4 - VT7** Threaded DIN3852-X-G $\frac{1}{2}$ A Flush-Mounted Diaphragm

Process coupling DIN 3852-X-G $\frac{1}{2}$

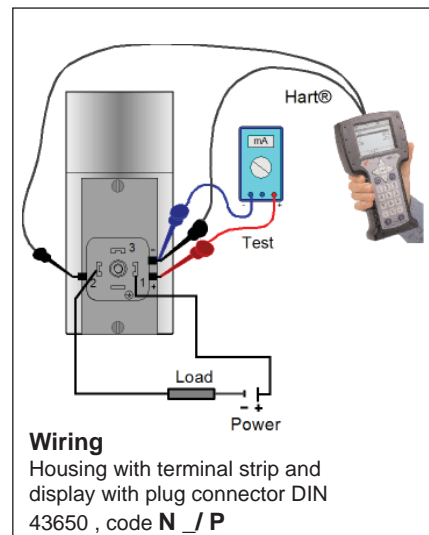
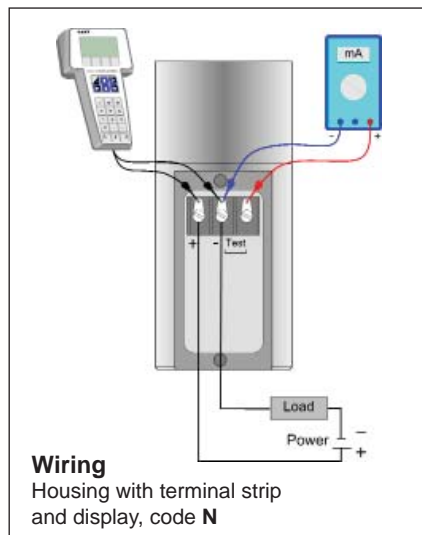
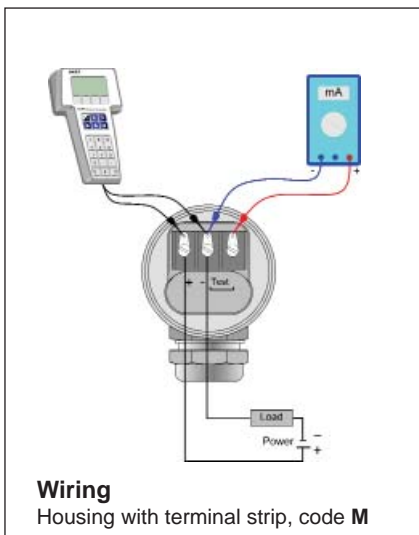

## Dimensions (mm)

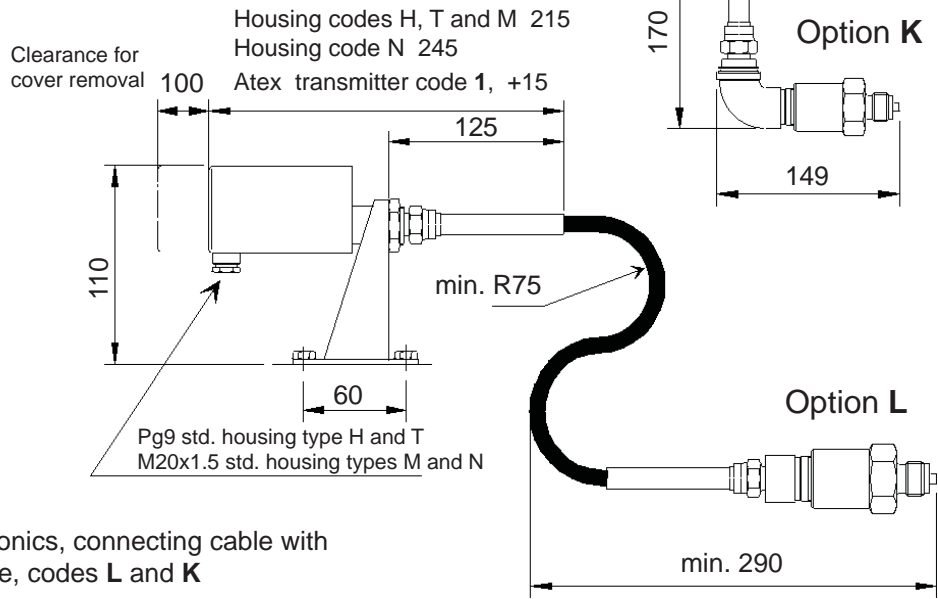

Remote electronics, connecting cable with protection hose, codes **L** and **K**

## Use of selector switch :

- RUN = working position
- PZ = Process value zero
- D = Damping adjustment
- S = Span adjustment
- Z = Zero adjustment
- DN = Down
- UP = Up

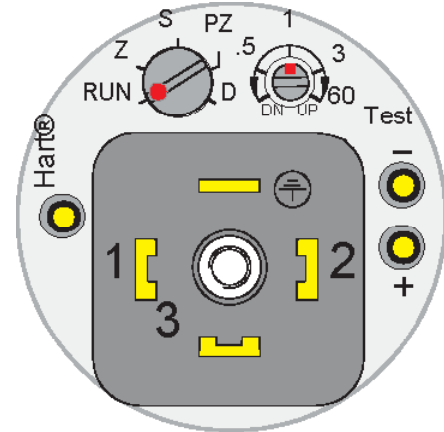

Housing with PLUG connector, code **T**



## Keyboard :

- Esc = Press **Esc** move back towards the top of the main menu.
- ▲ = Use the **UP** arrow key to move up on the current menu level or to increase the selected parameter value.
- ▼ = Use the **DOWN** arrow key to move down on the current menu level or to decrease the selected parameter value.
- Enter = Press **ENTER** to move to a lower level in a menu or to accept a command or parameter value.

Housing with display, code **N**

## Process temperature /°C

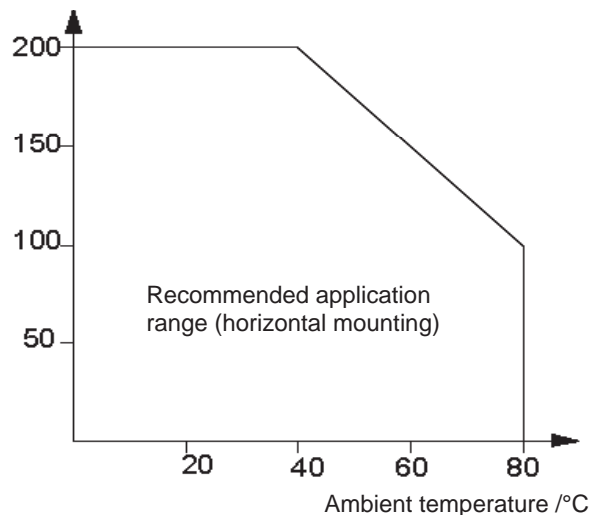

Process temperature limits for the transmitter of high temperature, process connection, code 3 (DIN3852-X-G1/2A, Flush mounted)

## Selection Chart

Adjustability	Span, min	Span, max	Measuring range
VT3	1.4 kPa (14 mbar)	35 kPa (350 mbar)	-35...+35 kPa (-350...350 mbar)
VT4	4 kPa (40 mbar)	100 kPa (1000 mbar)	-100...+100 kPa (-1000...1000 mbar)
VT5	10 kPa (100 mbar)	500 kPa (5000 mbar)	-100...+500 kPa (-1000...5000 mbar)
VTA5	10 kPa (100 mbar)	500 kPa (5000 mbar)	0...+500 kPa (0...5000 mbar), abs.
VT6	0.03 MPa (0.3 bar)	3 MPa (30 bar)	-0.1...+3 MPa (-1...+30 bar)
VTA6	0.03 MPa (0.3 bar)	3 MPa (30 bar)	0...+3 MPa (0...+30 bar), abs.
VT7	0.15 MPa (1.5 bar)	15 MPa (150 bar)	0...+15 MPa (0...+150 bar), abs.
VT8	1 MPa (10 bar)	100 MPa (1000 bar)	-0.1...+100 MPa (-1...+1000 bar)

<b>Output</b>	S 4-20mA DC/HART® -protocol		
<b>Process connection</b>	1 G 1/2A DIN 16288 (male) 2 1/2-NPT (male) 3 DIN 3852-X-G½A (male), Flush Mounted, not VT3, VT8		
<b>Wetted material</b>	<b>Body</b>	<b>Diaphragm</b>	
	Code Material	Code Material	
	2 AISI316L (EN 1.4404)	2 AISI316L (EN 1.4435) (no VT8)	
	3 Hast. C 276 (EN 2.4819)	3 Hast. C276 (EN 2.4819) (no VT3, VT8)	
	6 Titanium Gr2 (EN 3.7035)	5 Tantalum (no VT3, VT8) (*)	
	8 Duplex (EN 1.4462)	6 Titanium Gr2 (EN 3.7035) (no VT3, VT4) (*)	
		8 Duplex (EN 1.4462) (no VT3, VT8)	
<b>Fill fluid</b> (specify for types VT3 - VT7)	S Silicone oil	G Inert oil	
<b>Housing type</b>	H Housing with PLUG-connector, DIN43650, no display, inlet PG9		
	T Housing with PLUG-connector and with manual adjust, DIN43650, no display, inlet PG9, (no ATEX)		
	M Housing with junction box/terminal strip, no display, inlet M20x1,5		
	N Housing with junction box/terminal strip, with display, inlet M20x1,5		
<b>Explosion proof</b>	0 No explosion proof classification 1 Atex Intrinsic Safety,  II 1 GD T135°C (**)		

<b>Process coupling</b>	0 No coupling
	1 Threaded coupling G½, DIN 16288
	2 Threaded coupling G½, DIN 3852-X-G½ (Flush-Mounted)
<b>Special size of electrical inlet</b>	N 1/2 NPT G Pg13.5 P Plug DIN 43650

**Special features**

**Remote electronics** (specify only if housing connected with cable to sensing element)

- **connecting cable with protection hose**

L Hose protected with PTFE/AISI316 braiding, straight

K Hose protected with PTFE/AISI316 braiding, angle of 90°

**Length of connection cable between sensing element and housing**

2 2 m cable 3 3 m cable etc. (max. 10 meter)

**Mounting parts for remote electronics for Ø 51 mm tube**

0 No mounting parts 1 Mounting parts

**Documentation**

**Calibration certificate** AE English

**Installation and operating instructions** IE English IF Finnish

**Material certificates**

O No material certificate

MC1 Raw material certificate without appendices, in accordance with SFS-EN 10204-2.1 (DIN 50049-2.1) standard

MC2 Raw material certificate for wetted parts, in accordance with SFS-EN 10204-2.2 (DIN 50049-2.2) standard

MC3 Raw material certificate for wetted parts, in accordance with SFS-EN 10204-3.1 B (DIN 50049-3.1 B) standard

We reserve the right for technical modifications without prior notice.  
 HART® is a registered trademark of HART Communication Foundation.  
 Viton® is the registered trademark of DuPont Down Elastomers.  
 Hastelloy® is the registered trademark of Haynes International.  
 Teflon® is the registered trademark of E.I. du Pont de Nemours & Co

(\*) = not for process connection code 3

(\*\*) = Housing H and N :  II 2 GD T135°C

