

WALTHER PILOT

Betriebsanleitung / Operating Instructions



Automatische Spritzpistole / Automatik Spray Gun

Rohrwurm / Pipe Crawler

PILOT WA 81



AUSG. 05/12



Die Beschichtungs-Experten

EG-Konformitätserklärung

D

Wir, der Gerätehersteller, erklären in alleiniger Verantwortung, dass das Produkt in der untenstehenden Beschreibung den einschlägigen grundlegenden Sicherheits- und Gesundheitsanforderungen entspricht. Bei einer nicht mit uns abgestimmten Änderung an dem Gerät oder bei einer unsachgemäßen Verwendung verliert diese Erklärung ihre Gültigkeit.

Hersteller	WALTHER Spritz- und Lackiersysteme GmbH Kärntner Str. 18 - 30 D - 42327 Wuppertal Tel.: +49(0)202 / 787 - 0 Fax: +49(0)202 / 787 - 2217 www.walther-pilot.de • e-mail: info@walther-pilot.de		
Typenbezeichnung	Automatische Spritzpistole PILOT WA 81 Rohrwurm	V 20 381 00	
Verwendungszweck	Verarbeitung spritzbarer Materialien		
Angewandte Normen und Richtlinien			
EG-Maschinenrichtlinien 2006 / 42 / EG 94 / 9 EG (ATEX Richtlinien) DIN EN ISO 12100 Teil 1 DIN EN ISO 12100 Teil 2 DIN EN 1953 DIN EN 1127-1 DIN EN 13463-1			
Spezifikation im Sinne der Richtlinie 94 / 9 / EG			
Kategorie 2	Gerätebezeichnung		II 2 G c T 5
			Tech.File,Ref.: 2406
Bevollmächtigt mit der Zusammenstellung der technischen Unterlagen: Nico Kowalski, WALTHER Spritz- und Lackiersysteme GmbH, Kärntner Str. 18 - 30 D- 42327 Wuppertal			
Besondere Hinweise : Das Produkt ist zum Einbau in ein anderes Gerät bestimmt. Die Inbetriebnahme ist so lange untersagt, bis die Konformität des Endproduktes mit der Richtlinie 2006 / 42 / EG festgestellt ist.			

Wuppertal, den 01. Januar 2010

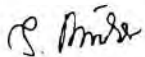
i.V. 

Name: Torsten Bröker
Stellung im Betrieb: Leiter der Konstruktion und Entwicklung

Diese Erklärung ist keine Zusicherung von Eigenschaften im Sinne der Produkthaftung. Die Sicherheitshinweise der Produktdokumentation sind zu beachten.

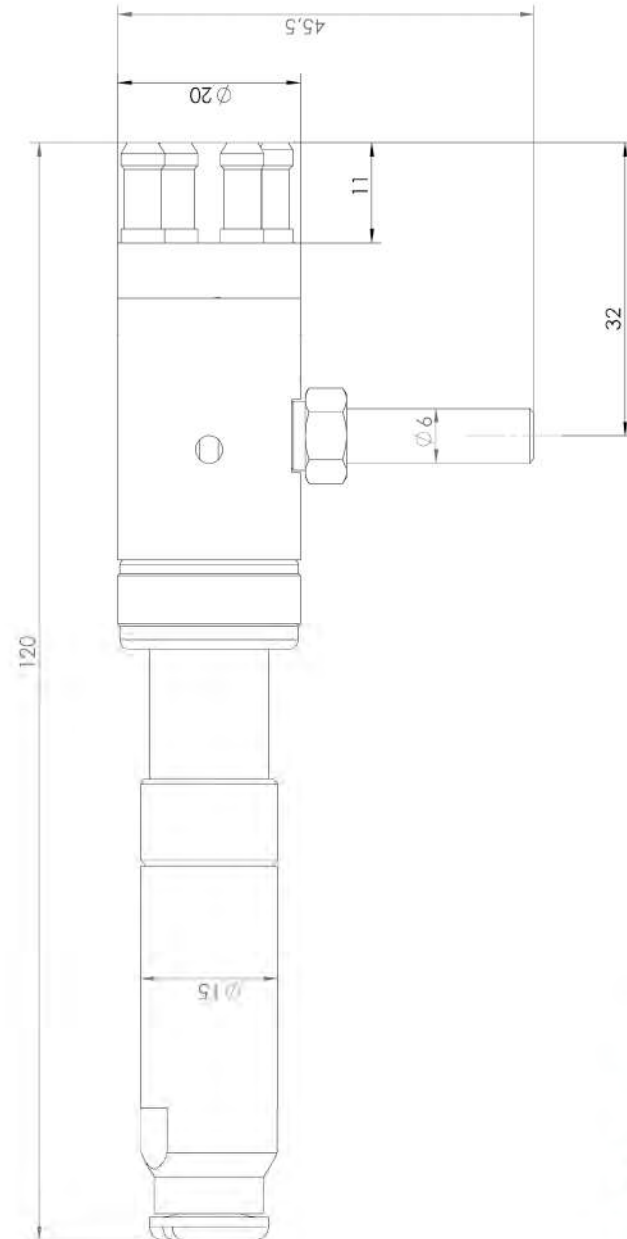

WA 81

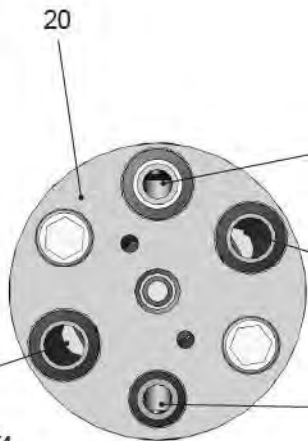
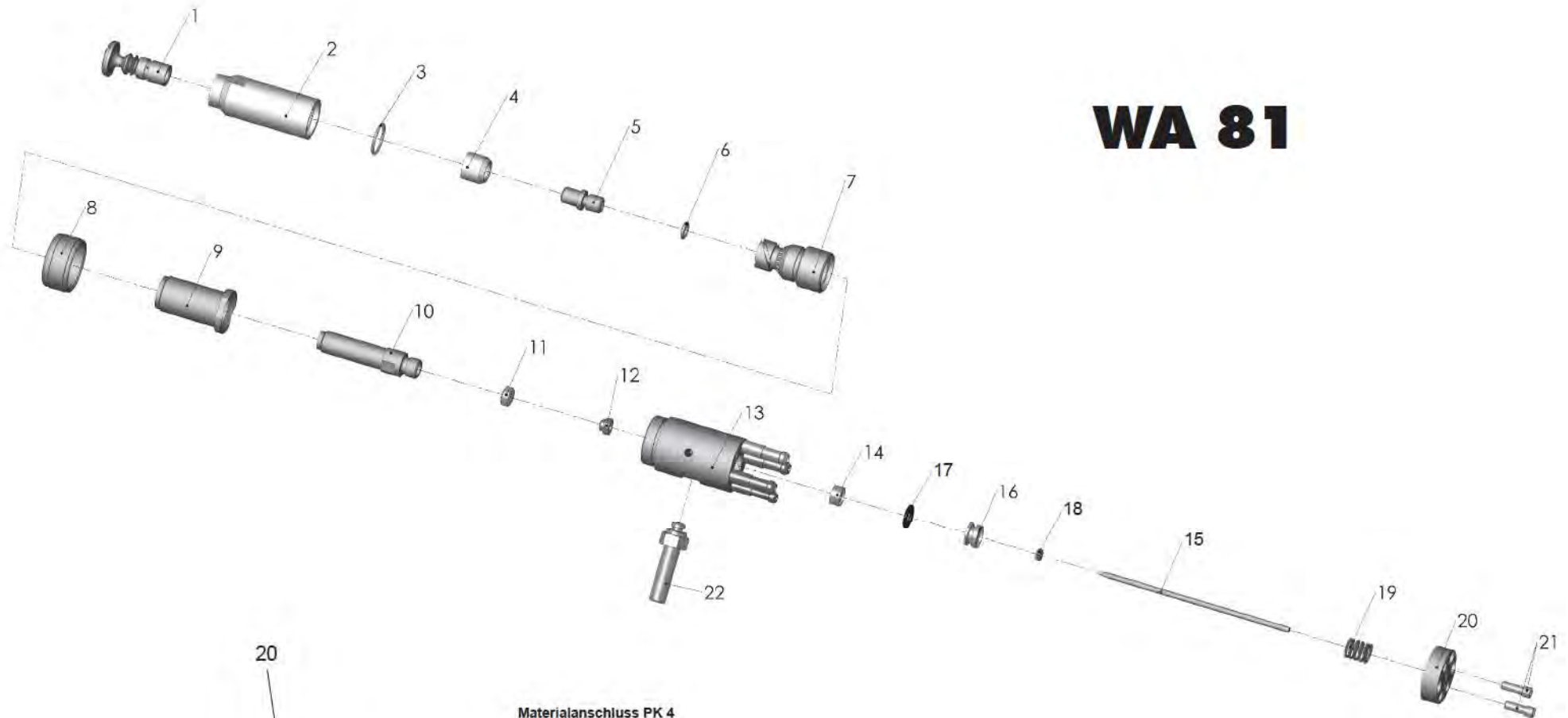

Materialanschluss PK 4
 Kennzeichnung: M
Material connection PK4
 Identification: M

Spritzluftanschluss PK 4
 Kennzeichnung: SP
Atomizing air inlet fitting PK4
 Identification: SP

Spritzluftanschluss PK 4
 Kennzeichnung: SP
Atomizing air inlet fitting PK4
 Identification: SP

Steuerluftanschluss PK 3
 Kennzeichnung: ST
Control air connection PK3
 Identification: ST

List of replacement parts PILOT WA 81

		PILOT WA 81	
		V 20 381	
Item	Description	Qty.	Art.-No.
1	Distributor cone	1	V 30 146 01 003
2	Air sleeve	1	V 30 146 03 003
3	O - ring	1	V 09 103 33 001
4	Distance sleeve	1	V 30 146 02 003
5	Material nozzle	1	V 30 146 05 . . 3*
6	O - ring	1	V 09 103 20 001
7	Head piece	1	V 30 146 04 003
8	Air cap nut	1	V 20 380 13 003
9	Air tube	1	V 20 380 10 003
10	Material tube	1	V 20 380 11 003
11	Packing screw	1	V 20 305 04 003
12	Needle seal complete	1	V 20 305 13 000
13	Housing, complete	1	V 20 306 01 003
14	Lip seal	1	V 09 220 26 000
15	Material needle	1	V 20 381 12 . . 3*
16	Piston	1	V 20 305 03 004
17	O - ring	1	V 09 102 21 001
18	Needle nut	1	V 20 305 07 003
19	Piston spring	1	V 20 305 12 005
20	Spring bushing	1	V 20 305 02 003
21	Hexagonal socket screw	2	V 20 305 08 003
22	Fastening bolt	1	V 20 305 14 003

* Please indicate the required sizes when placing an order for replacement parts. We recommend that **bold-face** replacement parts (i.e. wear parts) are held on stock.

Nozzle sizes optional:

- 1,0 • 1,5 mm ø

1 General

1.1 Identification of Model Versions

Models: Automatic Spray Guns PILOT WA 81

Type: Pipe Crawler V 20 381

Manufacturer: WALTHER Spritz-und Lackiersysteme GmbH
 Kärntner Str. 18-30
 D-42327 Wuppertal
 Tel.: 00 49 202 / 787-0
 Fax: 00 49 202 / 787-2217
 www.walther-pilot.de • Email: info@walther-pilot.de

1.2 Normal Use

The automatic spray gun PILOT WA 81 must be used only for processing sprayable materials in tubes and cavities and can be used for coating tubes with an inner diameter of up to approx. 500 mm. All material conduction parts are made of stainless steel so as to permit handling of hydrous and/or aggressive media such as:

- lacquers and paints
- grease, oil and anti-corrosion agents
- adhesives
- ceramic glazes
- stains

If you intend to spray materials that are not listed here, please contact WALTHER Spritz- und Lackiersysteme GmbH, Wuppertal.

The sprayable materials must be sprayed only on workpieces or objects.

The temperature of the material to be sprayed must not exceed 80°C.

The model PILOT WA 81 is not a hand-held spray gun and must therefore be mounted in a suitable bracket.

The term normal use also implies that any and all safety warnings, operational handling details, etc., as stated in these operating instructions, must be carefully read, understood and duly complied with.

This equipment complies with the explosion protection requirements of Directive 94 / 9 / EC (ATEX) for the explosion group, equipment category and temperature class indicated on the type plate.

When using the equipment, the requirements specified in these Operating Instructions must be observed at all times.

The technical data indicated on the equipment rating plates and the specifications in the chapter „Technical Data“ must be complied with at all times and must not be exceeded. An overloading of the equipment must be ruled out.

The equipment may be used in potentially explosive atmospheres only with the authorisation of the relevant supervisory authority.

The relevant supervisory authority or the operator of the equipment are responsible for determining the explosion hazard (zone classification).

The operator must check and ensure that all technical data and the marking of the equipment in accordance with ATEX are compliant with the necessary requirements.

The operator must provide corresponding safety measures for all applications in which the breakdown of the equipment might lead to danger to persons.

If any irregularities are observed while the equipment is in operation, the equipment must be put out of operation immediately and WALTHER Spritz- und Lackiersysteme must be consulted.

Grounding / Equipotential Bonding

You must ensure that the spray gun is properly earthed (grounded) either separately or in connection with the equipment with which it is being used (maximum resistance $10^6 \Omega$).

1.3 Improper Use

This spray gun shall not be used for purposes other than set forth in the above Chapter *Normal Use*. Any other form of use and/ or application is prohibited. Improper use is for example:

- spraying of material onto persons and animals
- spraying of liquid nitrogen, etc.

2 Technical Description

The model PILOT WA 81 is operated automatically by compressed air and is controlled via 3/2-way control valves. Hand-operated, foot-operated or solenoid-valve-operated valves can be used for this purpose.

First, the atomising air is introduced by a 3/2-way valve.

Then, the 3/2-way control valve required for the control air is actuated. The compressed air flowing into the cylinder chamber moves the control piston and opens the material feed.

If the control air is interrupted by the 3/2-way valve, the compressed air in the cylinder chamber is allowed to escape. The spring pressure of the piston spring shuts off the material feed to the material nozzle.

After this, the atomising air is switched off by the 3/2-way valve.

The spray gun works with the equal pressure method. This means that the atomising air pressure and the material pressure must be almost the same.

All parts which are in contact with the material are made of corrosion-free stainless steel.

3 Safety Instructions

3.1 Identification of Safety Instructions



Warning

The pictogram and the urgency level "Warning" identify a possible danger to persons. Possible consequences: Slight to severe injuries.



Attention

The pictogram and the urgency level "Attention" identify a possible danger to material assets.

Possible consequences: Damage to material assets.



Note

The pictogram and the urgency level "Note" identify additional information for the safe and efficient operation of the spray gun.

3.2 General Safety Instructions

The spray gun must be used only by trained and qualified persons.

All applicable accident prevention rules and regulations as well as other recognised industrial safety and health rules and regulations must be observed at all times.

Use the spray gun only in well-ventilated rooms. Fire, naked flames and smoking are strictly prohibited within the working area. WARNING – during the spraying of flammable materials (e.g. lacquers, adhesives, cleaning agents, etc.), there is an increased risk to health as well as an increased risk of explosion and fire.

Measures must be taken to ensure that the spray gun is sufficiently grounded (earthed) by means of a conductive air hose (maximum resistance $10^6 \Omega$).

Before carrying out maintenance or servicing work, always ensure that the air and material feed to the spray gun have been de-pressurised. Risk of injury!

When spraying materials, do not place your hands or other parts of the body in front of the pressurised nozzle or the spray gun. Risk of injury!

Never point the spray gun at persons or animals. Risk of injury!

Always observe the spraying and safety instructions given by the manufacturers of the spraying material and the cleaning agent. Aggressive and corrosive materials in particular can be harmful to health.

Exhaust air containing particles (overspray) must be kept away from the working area and personnel. In spite of these measures, always wear the regulation breathing masks and protective overalls when using the gun. Airborne particles represent a serious health hazard!

Always wear hearing protection when using the gun or when in the vicinity of a gun that is in use. The noise level generated by the spray gun is approx. 83 dB (A).

After carrying out assembly or maintenance work, always ensure that all nuts, bolts and screw connections have been fully tightened before the gun is used.

Use only original replacement parts, since WALTHER can only guarantee safe and fault-free operation for original parts.

For further information on the safe use of the spray gun and the spraying materials, please contact WALTHER Spritz- und Lackiersysteme GmbH, D-42327 Wuppertal, Germany.

4 Assembly

The spray gun is delivered fully assembled. Before using it, the following steps should be carried out:

4.1 Mounting of Spray Gun

Install the gun in a suitable and stable mounting device as shown in the following example:

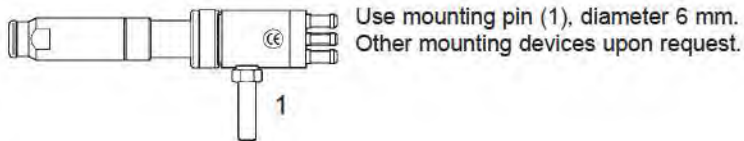

4.2 Connection of Input Lines

 **Warning**
Make sure not to confuse the control and atomizing air connections -risk of injury.

 **Warning**
Material and air hoses which are installed with a hose grommet must be additionally secured with a hose clamp.

- Connect the control air connector (via the 3/2-way valve) to the spray gun at „ST“ and set the control air pressure (min. 4.5 bar).
- Connect the atomizing air connector to the air hose (filtered compressed air supply) and to the atomizing air connections „SP“.
- Switch on the compressed air and set the required atomizing air pressure at the reducing valve (max. 6 bar).
- Fill the pressure pot with the material to be sprayed and close the lid.
- Connect the material feed hose to the pressure pot or the pump and to the material connection „M“. Set the required material pressure (max. 6 bar).
- Open the material valve on the pressure pot.

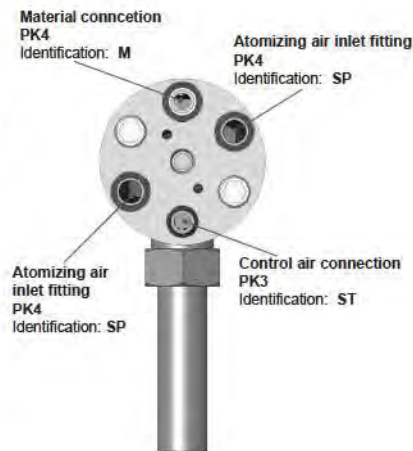

The spray gun is now properly installed and ready for operation.

5 Operational Handling

5.1 Safety Warnings

Please pay special attention to the following safety warnings prior to taking this spray gun into operation!

- The spray gun must be used only by trained and qualified persons.
- Wear proper respiratory protection masks and protective overalls, whenever you are operating this spray gun. Air-borne particles represent a health hazard.
- Make sure to wear suitable hearing protectors. The gun produces sound levels of up to 83 dB (A) which may cause hearing defects.
- Open fires, naked lights and smoking prohibited in the working area. Spraying of readily flammable media such as paints and adhesive compounds is always accompanied by the risk of fire and explosion.

5.2 Starting/Stopping Requirements

The following requirements must be met before the spray gun is operated:

- The control air pressure must be available at the gun
- The atomizing air pressure (round jet / flat jet) must be available at the gun
- The material pressure must be available at the gun.

 **Attention**
The material pressure should not exceed • 6 bar, since otherwise the operational reliability of the spray gun will be impaired. The spray gun works with the equal pressure method. This means that the atomizing air pressure and the material pressure must be almost the same.

The control air pressure should be set at • minimum of 4,5 bar, in order to operate the gun. The operation of the spray gun can be started/stopped by way of the 3/2-way control valve (see the operating instructions of the plant systems manufacturer).

 **Warning**
It is important to remember to relieve the spray gun of all pressures when work is terminated. Lines left under pressure may burst and the released material may injure any persons in the vicinity.

5.3 Spray Pattern Test

Spray pattern tests should be performed whenever:

- the spray gun is taken into operation for the first time;
- the spraying medium is changed;
- the spray gun was taken apart for maintenance or repair works.

The spray pattern is best tested using a workpiece sample, a sheet of metal, cardboard or paper.

**Warning**

Keep away from the front of the spray gun - imminent risk of injury.

**Warning**

Make sure that nobody is present in the spraying zone when the gun is started - imminent risk of injury.

1. Start the gun to produce a spray pattern sample (see 5.2. *Starting/Stopping Requirements*).
2. Inspect the sample and readjust the settings of the gun as may be required (see 5.4 *Spray Pattern Adjustments*).

5.4 Spray Pattern Adjustments

The spray pattern of the PILOT WA 81 can be adjusted as follows:

- The diameter of the atomising cone can be varied by changing the atomising air.
- The material flow rate is determined by the material pressure and the diameter of the material nozzle.

Adjustment of the Atomizing Air Pressure

The atomizing air pressure is adjusted at the air pressure reducing valve of the compressor system. Please comply with the operating instructions and safety warnings issued by the manufacturer.

Adjustment of the Material Pressure

This adjustment can only be made at the pump or the material pressure tank. Please comply with the operating instructions and safety warnings issued by the manufacturers concerned.

5.5 Retooling the spray gun

The combination of material nozzle and needle for a certain spraying material forms a specially matched unit - the nozzle assembly. Always exchange the complete nozzle assembly in order to maintain the desired spray pattern quality.

**Warning**

Prior to retooling: Make sure that the spray gun is in unpressurized condition, i.e. all air and material inputs must be shut off - if not, imminent risk of injury.

**Note**

Please refer to the exploded view (page 6) of these operating instructions to perform the steps detailed below.

Changing the distributor cone and the material nozzle

1. Unscrew the distributor cone (item 1) with a screw driver.
 2. Loosen the air head nut (item 8) (size 13) and remove the distance sleeve (item 4).
 3. Unscrew the material nozzle (item 5) together with the O-ring (item 6) with a size 3 hexagon key from the head piece (item 7).
 4. Replace the material nozzle together with the O-ring.
- Installation takes place in reverse order.

Changing the material needle

1. Unscrew the spring bushing (Item 20) from the body.
 2. Remove the piston spring (Item 19) and pull out the piston (Item 16) together with the material needle (Item 15).
 3. Unscrew the material needle from the piston.
- The setting dimension between the point of the needle and the face of the piston is 67 mm. Installation takes place in reverse order.

6 Cleaning and Maintenance

- Make sure that the spray gun is in unpressurized condition, i.e. all air and material inputs must be shut off - if not, imminent risk of injury.
- Open fires, naked lights and smoking is prohibited in the working area. There is an increasing risk of fire and explosion, when spraying readily flammable media (such as cleaning solutions).
- Observe all processing specifications and safety warnings issued by the manufacturer of cleaning media. Especially aggressive and corrosive media represents risks and hazard to personal health.
- Never immerse the spray gun in solvent or any other cleaning solution as such measure is very likely to affect the functional reliability and efficiency of the gun.
- Do not use any hard, pointed or sharp-edged objects when cleaning the spray gun, as the precision-made parts can be easily damaged and are likely to affect your spraying results.

To ensure that the spray gun functions properly and to maximise its service life, the spray gun must be maintained, cleaned and lubricated regularly.

Clean the gun only with cleaning solutions recommended by the manufacturer of the spraying material, which do not contain any of the following constituents:

- halogenated hydrocarbons (e.g. 1,1,1, trichloroethane; methylene chloride, etc.)
- acids and acidiferous cleaning solutions
- regenerated solvents (so-called cleaning dilutions)
- paint removers

The above constituents cause chemical reactions with electroplated components resulting in corrosion damage. WALTHER is not responsible for damages resulting from this kind of treatment.

Clean the spray gun

- prior to each change of the spraying medium
- at least once a week
- as often as may be required by the spraying medium handled and the resulted degree of fouling.

1. Dismantle the gun as described in section 5.5 *Retooling the Spray Gun*.
2. Clean the nozzle with a brush dipped in the recommended cleaning solution.
3. Clean the gun body and all remaining parts with a soft cloth and the recommended cleaning solution.
4. Apply a thin layer of grease to the following parts:
 - Material needle
 - Piston spring
 - O-ring of the piston

Use non-acidic, non-resinogenic grease and a brush. The spray gun is then reassembled in reverse order.

7 Repairs



Warning

Prior to any repairs: Make sure that the spray gun is in unpressurized condition, i.e. all air and material inputs must be shut off - if not, imminent risk of injury.



Note

Please use the drawing (page 6) of these operating instructions to perform the following procedures.

7.1 Replacement of Material Nozzles and -Needles

Dismantle the spray gun in accordance with Chapter 5.5 *Changing of Material Nozzle and Needle*, if the following components have to be replaced:

- Material Nozzle
- Piston Spring*
- Material Needle*
- Piston O-Ring*



Note

Parts marked with * must be lubricated with non-acidic, non-resinogenic grease prior to installation.

7.2 Changing the Needle Seal

1. Dismantle the material nozzle and needle as outlined in section 5.5.
2. Unscrew the head piece (item 7) from the air tube (item 9).
3. Unscrew the air head nut (item 8) from the housing (item 13) and remove the air tube (item 9).
4. Unscrew the material tube (item 10).

5. Unscrew the packing screw (item 11) from the housing (item 13).
6. Pull out the needle seal (item 12) from the housing. You may need to use a thin wire with the end bent to a hook.

Installation takes place in reverse order.



Note

Never reinstall a used needle seal (Item 12) as otherwise the functional sealing reliability of the spray gun will suffer.

The wear parts are marked in bold face in the replacement parts list.

8 Troubleshooting and Corrective Action



Warning

Prior to any servicing and repair work: Make sure that the spray gun is in unpressurized condition, i.e. all air and material inputs must be shut off - if not, imminent risk of injury.

Fault	Cause	Remedy
Gun is dripping	Material control nozzle (Item 15) or needle (Item 5) fouled	see 5.5 Removing Material Nozzle or Needle and cleaning
	Material control nozzle or needle damaged	see 5.5 Replacing Material Control Nozzle or Needle
Gun fails to open	Control air pressure too low	Increase control air pressure to at least 4.5 bar
Material bubbling in material container	Atomising air is entering the material container via the material channel	Clean the parts, tighten or replace
	Material nozzle (Item 5) or air tube (Item 9) not properly tightened.	
Spray jet pulsating or unsteady	Level in material tank too low	Top-up material level (see operating instructions of plant systems manufacturer)
Spray fan one-sided	Distributor cone damaged or dirty	Remove and clean
Material leaks from leakage boring	Needle seal packing (Item 12) leaks	exchange

9 Disposal of Cleaning / Servicing Substances

Disposal of any such substances must be in accordance with all applicable local and national regulations, directives and laws.



Warning

Pay special attention to all processing specifications and safety warnings issued by the manufacturers of spraying and cleaning media. The improper disposal of any toxic waste material represents a serious threat to the environment, i.e. to the health of mankind and animal life.

10 Technical Data

Weight: 144 Gramm

Connections:

Atomizing Air: 2x PK 4
Control Air: PK 3
Material Inlet: PK 4

Pressure Ranges:

Control air Pressure: min. 4,5 bar
Material pressure: max. 6 bar
Atomizing air pressure: max. 6 bar

Sound Level:

(measured at a distance
of 1 m from the spray gun) 83 dB (A)

Air Consumption at:

1 bar atomizing air pressure: 1,2 m³ /h
2 bar atomizing air pressure: 1,8 m³ /h
3 bar atomizing air pressure: 2,4 m³ /h
4 bar atomizing air pressure: 3,0 m³ /h
5 bar atomizing air pressure: 3,6 m³ /h
6 bar atomizing air pressure: 4,8 m³ /h

Right to effect technical changes reserved.

Das WALTHER PILOT- Programm

- Hand-Spritzpistolen
- Automatik-Spritzpistolen
- Niederdruck-Spritzpistolen (System HVLP)
- Zweikomponenten-Spritzsysteme
- Materialfördersysteme
- Materialdruckbehälter
- Drucklose Behälter
- Rührwerk-Systeme
- Farbwechsler
- Airless-Geräte und Flüssigkeitspumpen
- Kombinierte Spritz- und Trockenboxen
- Absaugsysteme mit Trockenabscheidung
- Absaugsysteme mit Nassabscheidung
- Trockner
- Zuluft-Systeme
- Atemschutzsysteme und Zubehör

The WALTHER PILOT Programme

- Hand-Held Spray Guns
- Automatic Spray Guns
- Low Pressure Spray Guns (System HVLP)
- Two-Component Spray Guns
- Material Pressure Tanks
- Nonpressurized Tanks
- Agitator Systems
- Airless Equipment and Transfer Pumps
- Material Circulation Systems
- Combined Spraying and Drying Booths
- Spray Booths with Filter Mats
- Spray booths with Water-Wash Function
- Powder Spray Stands
- Dryers
- Ventilation Systems
- Protective Respiratory Systems and Accessory Items



Die Beschichtungs-Experten

WALTHER Spritz- und Lackiersysteme
Kärntner Str. 18-30 • 42327 Wuppertal
Telefon: 0202 / 787-0 • Telefax: 0202 / 787-2217
www.walther-pilot.de
E-mail: info@walther-pilot.de

