

azbil

Digital Fiber-Optic Sensors

HPX-AG ~Advanced Grade~

HPX-EG ~Easy Grade~



Please read the "Terms and Conditions" from the following URL before ordering or use:

<http://www.azbil.com/products/bi/order.html>

Other product names, model numbers and company names may be trademarks of the respective company.

[Notice] Specifications are subject to change without notice.
No part of this publication may be reproduced or duplicated without the prior written permission of Azbil Corporation.

Azbil Corporation
Advanced Automation Company

Yamatake Corporation changed its name to Azbil Corporation on April 1, 2012.

1-12-2 Kawana, Fujisawa
Kanagawa 251-8522 Japan

URL: <http://www.azbil.com>

1st Edition : Issued in Mar. 2010-JBA
3rd Edition : Issued in Feb. 2013-JBA

HPX-AG (Advanced Grade)

HPX-EG (Easy Grade)

Sensing Satisfaction

— Freedom from Frequent Adjustments —

Two models are available, both offering easy operation and a wealth of functions. Compatible with an extensive range of applications.



Fuss-free setting and adjustment

Direct tuning

Simply press the auto-tuning button to tune the sensor, and press the +/- buttons to fine-tune the preset values. No need to switch to SET mode.

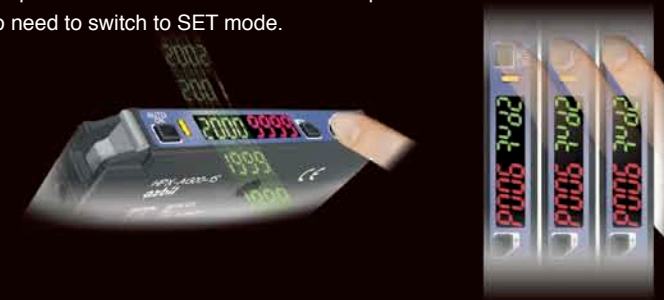

Reduced wiring

Up to 16 units, including a main unit (with power cable) and expansion units (without power cable) can be connected together. It goes without saying that the HPX-AG and HPX-EG can be used in conjunction. Since power to the expansion units is supplied via connectors from the main unit, only a single wire is required for each expansion unit.



Basic operation

- Auto-tuning button
Just two presses of the button and auto-tuning is complete.
- +/- buttons
Threshold values can be adjusted directly.
- Function selection button
Provides an easy-to-understand menu for functions such as the LO/DO switch, key lock, and timer setting.



Global standards compliance

Models complying with CE, UL and S-mark standards are available for safe use in export units.



Superior auto-tuning

Incorporates not only standard 2-point tuning, but also BGS tuning (without a target object), percent tuning and full auto-tuning.

<h3>2-point tuning</h3> <p>With a target object</p> <p>Without a target object</p>	<h3>BGS tuning</h3> <p>Setting at the maximum sensitivity that will not detect the background.</p> <p>No target object</p> <p>Background</p>	<h3>Percent tuning</h3> <p>For example, set to the desired percent of the value without a target object.</p> <p>No target object</p>	<h3>Full auto-tuning</h3> <p>Setting is based on light-level change during full auto-tuning. This allows setting without stopping the workpiece.</p> <p>One-press start or stop</p> <p>HPX-AG only</p>
--	--	--	--

*Some models do not have full auto-tuning. For details, refer to the user's manuals.

HPX-AG

— Advanced Grade —

Sensing Satisfaction

Extensive Special Features for
Full Satisfaction of
Your Sensing Needs

Long-term
stability

High-precision
detection

Selectable
special
features



Stability

With 4-element LED and APC, light emission is twice as stable

Four-element LEDs shine brightly for longer than conventional ones, and LED brightness is monitored by Auto Power Control (APC), which regulates the current to maintain light emission at a constant level.

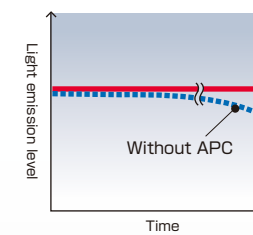

Note: APC controls the light emission level of the LED, but does not compensate for a drop in the received light level arising from other factors.

Shared feature (all models)

Superior timer functions

A combination timer is provided together with the standard on-delay/off-delay and one-shot timer functions

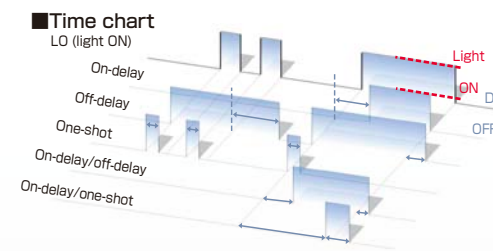

Timer setting time	
Timer setting range	Setting unit
250μs/500μs	—
1ms~5ms	500μs
6ms~99ms	1ms
100ms~900ms	100ms
1s~90s	1s

Performance

Five selectable sensing modes

Five sensing modes allow you to choose the response speed and sensitivity that is best for your application.

High sensitivity	Sensing mode	Response speed	Display maximum
↑	HP (high power)	5ms	9999
	nL (normal)	1ms	9999
	SF (semi-fast)	500μs	5000
	FT (fast)	250μs	4000
	HS (high speed)	50μs (NPN) 58μs (PNP)	4000
↓			
High speed			

High-accuracy detection

Note: Numerical values assume optimum conditions

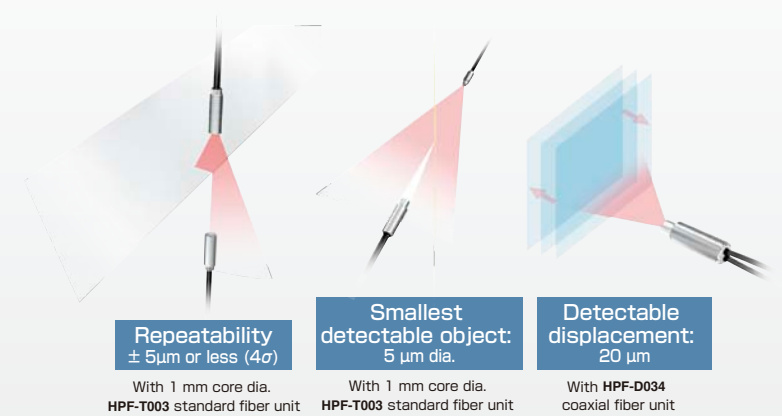

Model-specific features

Models with special features are available for a wide variety of applications.

Remote tuning models (HPX-AG01 & HPX-AG03)

Tuning can be done remotely from a connected device. Tuning automatically sets the sensor to the optimal sensitivity.

Sample use:
Substrate detection with a rail width change

When there is a change in the rail width or type of substrate, using remote tuning reduces the setup time required.

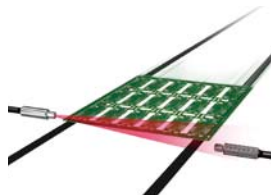

Alarm output model (HPX-AG02)

This sensor warns if the scanning conditions are unsuitable by means of a second output (light-level drop alarm output).

Sample use:
Surface detection of liquids such as slurry

An alarm signal indicating a drop in the light level is output if the inside wall of the pipe becomes dirty, averting potential problems.

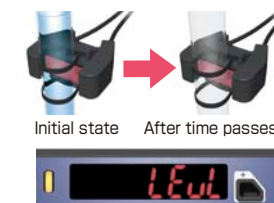

Data bank model (HPX-AG09)

Up to 8 sets (data banks) of settings (preset value, sensing mode, timer and so on) can be swapped either by external input or manually.

Sample use:
Differentiation of target objects after a type change

When the sensing setup changes, sensors can be reconfigured by an external device, with considerable savings in tuning man-hours.

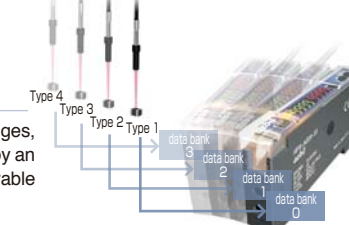

Synchronous external input model (HPX-AG11)

This model accepts the output of another sensor or PLC and uses it together with the sensing data to determine sensor output.

Sample use: Top/bottom differentiation for parts

With the output of a target-object detection sensor as a trigger, the sensor differentiates the top and bottom of a part. This reduces the number of wires that must be connected to the controlling device.

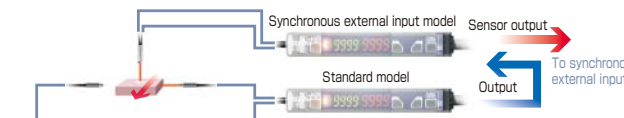

Dual output model (HPX-AG06) Active zone model (HPX-AG07)

Sample use: Sheet position deviation detection

• Dual output model
With upper and lower deviation limits set for a sheet's position, two outputs enable the user to detect any deviation in the position of the sheet.

• Active zone model
After positional reference points are set, a single output enables the user to determine whether deviation in the sheet's position is within the allowable range.

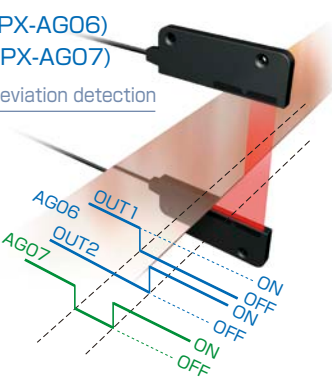

Differential setting model (HPX-AG08)

Unaffected by gradual light-level changes or stain buildup, this model provides stable detection. In addition, as the light level differentiation signal is transmitted as a second output, this model provides advance notice of sensitivity limitations.

Sample use:
Detection of small components moving through pipe

The passage of small components can be detected reliably without concern for errors arising as a result of stain buildup in the pipe.

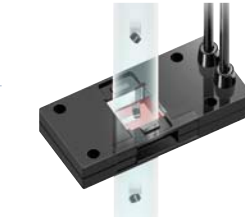

HPX-AG Function Table

		AG00	AG01	AG02	AG03	AG04	AG05	AG06	AG07	AG08	AG09	AG10	AG11
Auto-tuning	Full auto-tuning	●		●	●	●	●				●	●	●
Remote tuning	Remote tuning		●	●	●								
	Tuning error output			●									
Special detection	Dual output setting						●						
	Zone setting							●					
Advanced function timer	Differential setting + light-level differentiation setting							●					
	Heartbeat output						●	●	●	●	●	●	●
Alarm output	Control output latch						●						
	APC output*			●			●						
Special input	Light level drop/stability margin alarm output			●			●						
	Latch cancellation input						●						
	Light emission LED control input							●					
	Data bank switch input									●	●		
	Synchronous external input											●	

*APC output is produced when the auto power control's compensation function nears its limit.

HPX-EG

— Easy Grade —

Freedom from Frequent Adjustments

Auto-adjustment function offers easy-to-operate, stable detection

Fuss-free adjustment

Easy operation

Eco-friendly



Fuss-free adjustment

Auto sensitivity switch function

This function automatically optimizes the sensitivity setting during auto tuning, affording easy operation while delivering the highest detection performance.

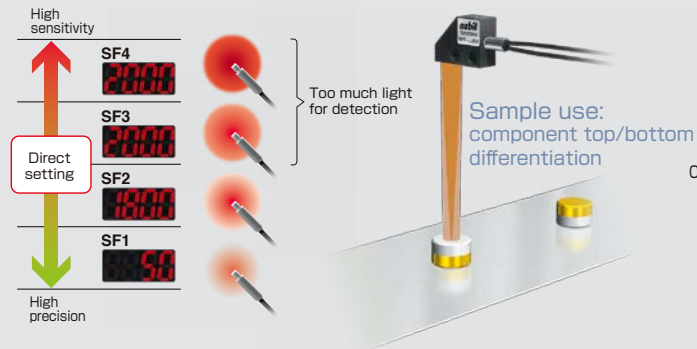

STA (Self Threshold Adjustment) function

This function allows the level of received light to be set as a reference point, enabling the detection threshold to be automatically adjusted by a given ratio in an updating cycle. This ensures the stable detection of target objects, eliminating the effect of fluctuations in the received light level due to environmental changes.

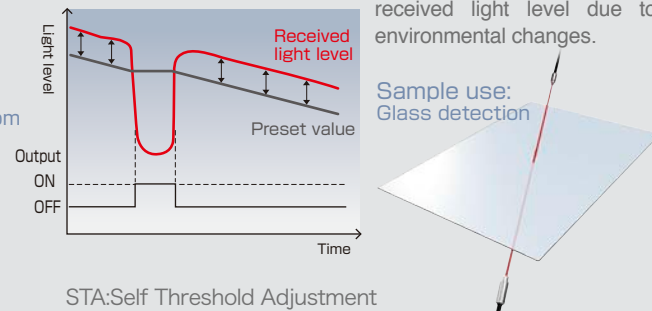

Easy operation

Easy-to-understand excess gain indication

The excess gain indication varies from 0% (dark) to 99% (light), with a preset value of 100%. Variations in the received light indication can be eliminated in the same application.



Sample use: Liquid surface detection



	Absolute value indication			Excess gain indication	
	Preset value	Without liquid	With liquid	Without liquid	With liquid
High high limit sensor	2035	3800	270	P 187	P 13
High limit sensor	1874	3500	248	P 187	P 13

Note: Formula for excess gain indication: received light level / preset value × 100

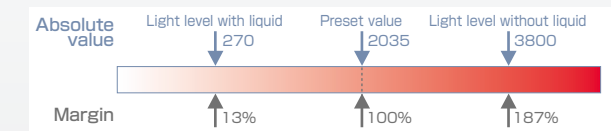

Performance

Three selectable sensing modes

Three sensing modes can be selected by the desired response speed and sensitivity, according to what is best for your application.

High sensitivity	Sensing mode	Response time	Display maximum
↑	nL(normal)	1ms	4000
↕	SF(semi-fast)	500μs	2000
↓	FT(fast)	250μs	1000

High accuracy detection

Note: Numerical values assume optimum conditions

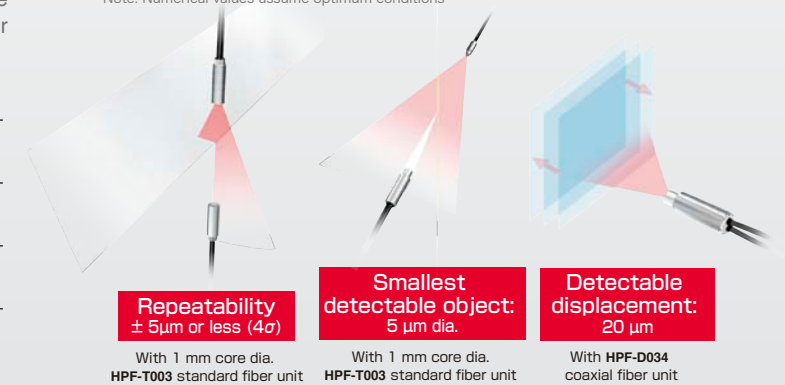

Eco-friendly measures

Standardization of code lengths to 1 m

“Shorter codes can do the job” and “Cut codes only end up in the garbage!” In response to comments like these from our customers, we came to the decision that 1 m codes were sufficient for standard HPX-EGs. This reduces the quantity of waste generated, contributing to the protection of our natural environment.



Model number selection

HPX-AG 00 -1S -L05 (typical model number example)

Basic model No.	Model	Output	Code	Features
HPX-AG	00			Standard
	01			Remote tuning
	02			Alarm output
	03			Tuning error
	04			Advanced function timer
	05			LED light emission control (remote power control)
	06			Dual output, dual preset values
	07			Active zone setting
	08			Differential setting
	09			Data bank (4 sets of settings)
	10			Data bank (8 sets of settings)
	11			Synchronous external input
		NPN PNP		
		-1S -2S		Code lead-out*1
		-3S -4S		Reduced wiring (main unit)*1
		-5S -6S		Reduced wiring (expansion unit)*1
		(Blank)		2 m code (standard)
		-L05		5 m code



Note: Please refer to the compatibility list for compatible cables.
 Note: For models that comply with UL and S-mark standards, please contact Yamatake Corporation.

*1	Model	Code lead-out	Reduced wiring	
			Main unit	Expansion unit
	AG00	●	●	●
	AG01	●	●	●
	AG02	●		
	AG03	●		
	AG04		●	●
	AG05		●	●
	AG06		●	●
	AG07		●	●
	AG08		●	●
	AG09		●	●
	AG10			●
	AG11		●	●

HPX-EG 00 -1S -L02 (typical model number example)

Basic model No.	Model	Output	Code	Features	
HPX-EG	00			Standard	
	01			Remote tuning	
			NPN PNP		
			-1S -2S		Code lead-out
			-3S -4S		Reduced wiring (main unit)
			-5S -6S		Reduced wiring (expansion unit)
			(Blank)		1 m code (standard)
		-L02		2 m code	
		-L05		5 m code	

Amplifier unit accessories

Product name	Appearance	Features / Applications	Model
Dedicated mounting bracket 1 pc		This dedicated bracket can be used instead of a DIN rail to mount a single amplifier. It is not included with the amplifier.	HPX-PA04
End plates 2 pcs		End plates used when mounting on a DIN rail. They are not included with the amplifier.	HPX-PA03

Scanning range

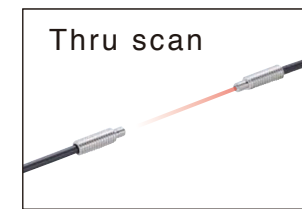

Type	Model	Amp model	HP(5ms)	nL(1ms)	SF(500μs)	FT(250μs)	HS(50μs)
Standard fiber	HPF-T003	HPX-AG	1,200	800	640	350	200
		HPX-EG	—	340	290	200	—
Unbreakable fiber	HPF-T024	HPX-AG	140	95	75	40	23
		HPX-EG	—	41	35	24	—
Heat resistant	HPF-T018	HPX-AG	615	410	325	175	100
		HPX-EG	—	115	100	65	—
Chemical resistant	HPF-T029	HPX-AG	4,500	3,000	2,400	1,310	750
		HPX-EG	—	1,230	1,050	720	—
Area sensor	HPF-T021T	HPX-AG	3,600	2,400	1,920	1,050	600
		HPX-EG	—	935	850	550	—

Unit: mm



Type	Model	Amp model	HP(5ms)	nL(1ms)	SF(500μs)	FT(250μs)	HS(50μs)
Standard fiber	HPF-D002	HPX-AG	400	300	240	130	65
		HPX-EG	—	130	110	70	—
Unbreakable fiber	HPF-D029	HPX-AG	25	19	15	8	4
		HPX-EG	—	8	7	4	—
Heat resistant	HPF-D023	HPX-AG	170	130	100	55	28
		HPX-EG	—	55	50	32	—
Chemical resistant	HPF-D014	HPX-AG	170	130	100	55	28
		HPX-EG	—	55	50	32	—
Coaxial	HPF-D035	HPX-AG	95	95	80	43	21
		HPX-EG	—	41	35	22	—

Unit: mm

HPX-AG

Specifications

Code lead-out typeType		HPX-AG**-1S	HPX-AG**-2S
Reduced wiring type	Main unit	HPX-AG**-3S	HPX-AG**-4S
	Expansion unit	HPX-AG**-5S	HPX-AG**-6S
Light emitter		Red four-element LED (650 nm)	
Power		12-24 Vdc ±10 % (ripple: 10 % max.)	
Output type		NPN open collector	PNP open collector
Current consumption		750 mW or less (30 mA consumption current with power supply voltage of 24 V)	
Control output	Switching current	Code lead-out typeType	Single output model 100 mA or less Dual output model 50 mA or less
		Reduced wiring type	Single output model 50 mA or less Dual output model 30 mA or less
	Residual voltage	2 V or less 3 V or less	
	Output withstand voltage	26.4V	
External input	ON	0-1 V DC (short-circuit current approx. 0.1 mA)	8-26.4 V DC (short-circuit current approx. 0.1 mA)
	OFF	Open or connection to + side of power supply	Open or connection to positive side of power supply
Response time		50μs(High Speed)/250μs(Fast)/500μs(Semi Fast)/1ms(Normal)/5ms(High Power)*2	
Mutual interference prevention		8 units	
Expansion unit addition		Up to 15 expansion units can be connected.	
Indicator		Output indicator (Turn on with output on)	
Ambient light immunity		Incandescent light: 5,000 lux max. Sunlight: 20,000 lux max.	
Operating temperature		-20 to +55*1	
Operating humidity		35-85 % RH (without condensation)	
Vibration resistance		10-55 Hz, 1.5 mm peak-to-peak amplitude, 2 hours each in X, Y and Z directions	
Shock resistance		500 m/s ² , 3 times each in X, Y and Z directions	
Protection circuits		Short-circuit protection circuit for power, malfunction prevention circuit at power ON (approx. 300 ms), power reverse connection protection circuit	
Case material		Body: PC resin. Cover: PC resin	
Weight		Code lead-out typeType:Approx. 75 g Reduced wiring type(main unit):Approx. 75 g Reduced wiring type(Expansion unit):Approx. 40 g	

*1. The operating temperature varies depending on the number of gang-mounted sensor units as follows. 1 or 2 units: -20 to +55°C; 3 units: -20 to +50°C; 4 or 5 units: -20 to +45°C; 6 units: -20 to +40°C

*2. The HPX-AG06 and HPX-AG07 do not have Fast or High Speed settings for the response time. After Semi Fast, the next fastest speed is Semi-High Speed (140 μs). For details on the response time for the HPX-AG08 (differential setting model), please contact Yamatake Corporation. PNP High Speed output is 58 μs.

Input/output

Model	HPX-AG00-**-	HPX-AG01-**-	HPX-AG09-**-	HPX-AG10-**-	HPX-AG06-**-	HPX-AG02-**-
		HPX-AG07-**-	HPX-AG04-**-			HPX-AG08-**-
		HPX-AG11-**-				HPX-AG05-**-
Control output	1 output	1 output	1 output	1 output	2 outputs	2 outputs
External output	—	1 input	2 inputs	3 inputs	—	1 input

■ Detailed View of the Operating Panel

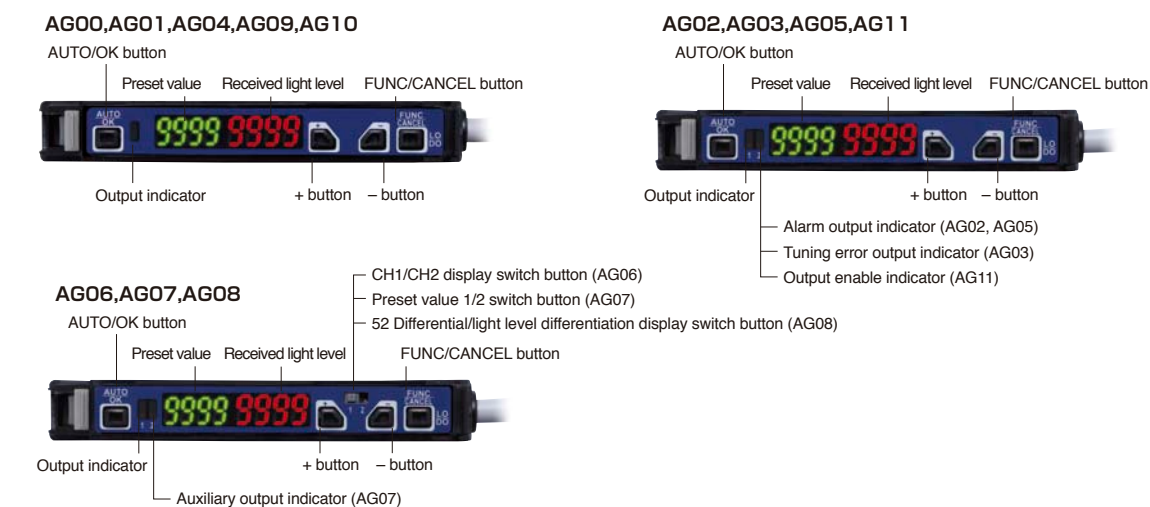

HPX-EG

Specifications

Code lead-out typeType		HPX-EG**-1S	HPX-EG**-2S
Reduced wiring type	Main unit	HPX-EG**-3S	HPX-EG**-4S
	Expansion unit	HPX-EG**-5S	HPX-EG**-6S
Light emitter		Red four-element LED (635nm)	
Power		12-24 Vdc ±10 % (ripple: 10 % max.)	
Output type		NPN open collector	PNP open collector
Current consumption		750 mW or less (30 mA consumption current with power supply voltage of 24 V)	
Control output	Switching current	Code lead-out typeType	100 mA or less
		Reduced wiring type	50 mA or less
	Residual voltage	2 V or less 3 V or less	
	Output withstand voltage	26.4V	
External input	ON	0-2 V DC (short-circuit current approx. 0.1 mA)	7.2-26.4 V DC (short-circuit current approx. 0.1 mA)
	OFF	Open or connection to + side of power supply	Open or connection to positive side of power supply
Response time		250μs(Fast)/500μs(Semi Fast)/1ms(Normal)	
Mutual interference prevention		2 units	
Expansion unit addition		Up to 15 expansion units can be connected.	
Indicator		Output indicator (Turn on with output on)	
Ambient light immunity		Incandescent light: 5,000 lux max. Sunlight: 20,000 lux max.	
Operating temperature		-20 to +55*1	
Operating humidity		35-85 % RH (without condensation)	
Vibration resistance		10-55 Hz, 1.5 mm peak-to-peak amplitude, 2 hours each in X, Y and Z directions	
Shock resistance		500 m/s ² , 3 times each in X, Y and Z directions	
Protection circuits		Short-circuit protection circuit for power, malfunction prevention circuit at power ON (approx. 300 ms)	
Case material		Body: PC resin. Cover: PC resin	
Weight		Code lead-out typeType:Approx. 45 g Reduced wiring type(main unit):Approx. 45 g	

*1. The operating temperature varies depending on the number of gang-mounted sensor units as follows. 1 or 2 units: -20 to +55°C; 3 units: -20 to +50°C; 4 or 5 units: -20 to +45°C; 6 units: -20 to +40°C

Input/output

Model	HPX-EG00-**-	HPX-EG01-**-
Control output	1 output	1 output
External output	—	1 input

■ Detailed View of the Operating Panel

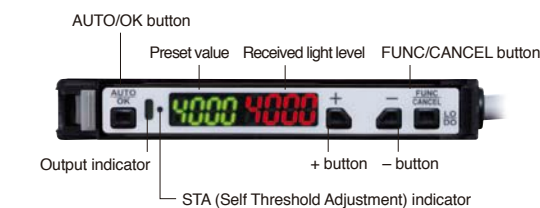

HPX-AG HPX-EG

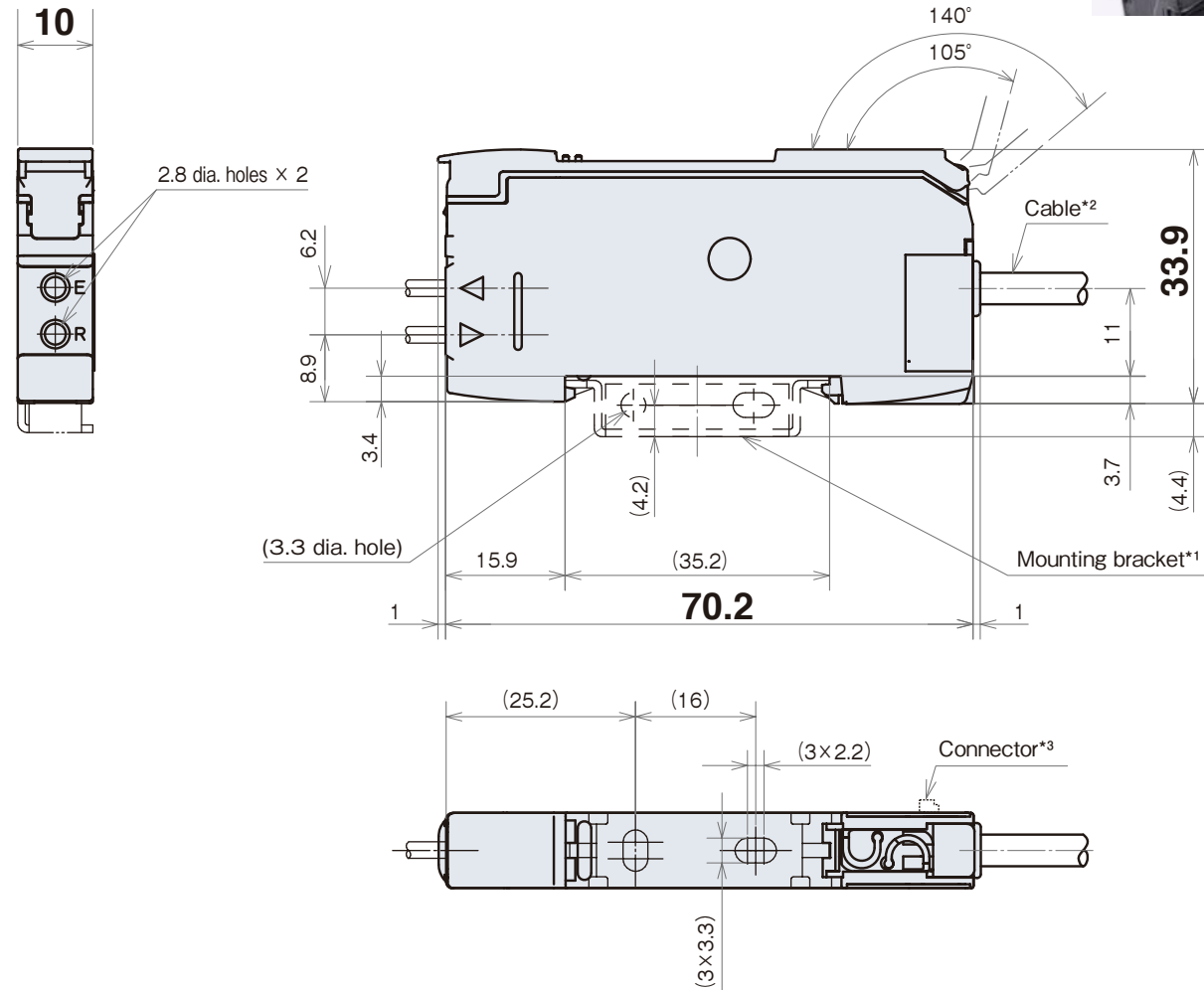

*1. Mounting bracket sold separately (catalog listing: **HPX-PA04**).

*2. **HPX-AG00-5S/6S** and **HPX-AG07-5S**
HPX-EG00-5S/6S
Outer diameter: 2.6;
insulator diameter: 1.2;
nominal cross-section: 0.2 mm²

Models other than the above
Outer diameter: 4.2;
insulator diameter: 1.2;
nominal cross-section: 0.2 mm²

*3. The reduced-wiring type expansion unit has a connector structure (male) for attaching additional units.

Wiring diagram for the amplifier

The output switching device is FET.
Reduced wiring type expansion units are not equipped with a power wires (brown and blue) since power is supplied through the main unit.

- HPX-AG00 / AG07
- HPX-EG00

NPN open collector output

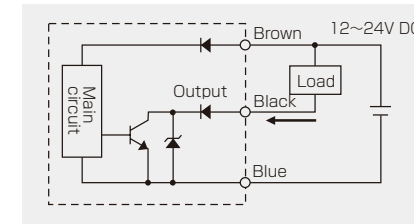

PNP open collector output

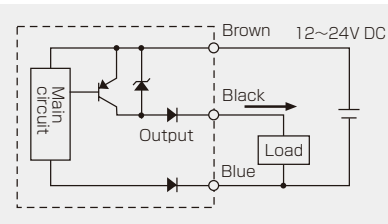

- HPX-AG01 / AG04 / AG11
- HPX-EG01

NPN open collector output

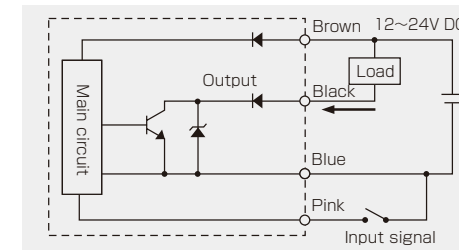

PNP open collector output

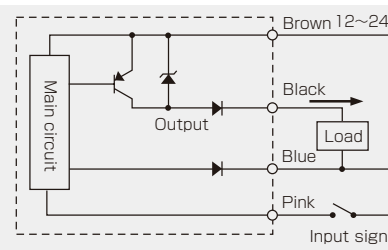

Model	Input signal (pink)
AG01	Remote tuning input
AG04	Latch cancellation input
AG11	Synchronous external input
EG01	External input

- HPX-AG02 / AG03 / AG05

NPN open collector output

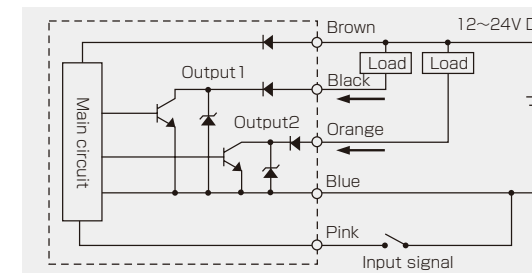

PNP open collector output

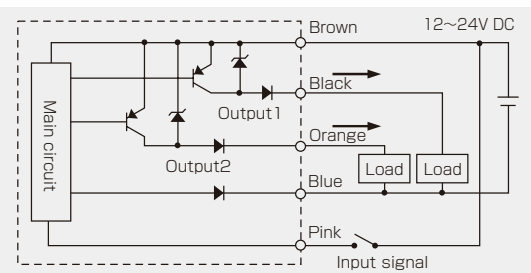

Model	Input signal (pink)
AG02	Remote tuning input
AG03	Remote tuning input
AG05	Light emission LED control input

- HPX-AG06 / AG08

NPN open collector output

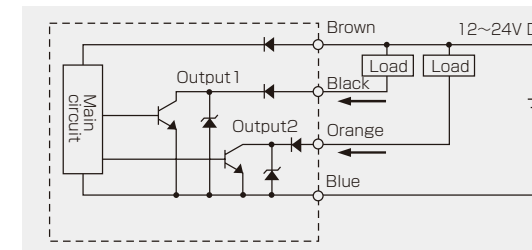

PNP open collector output

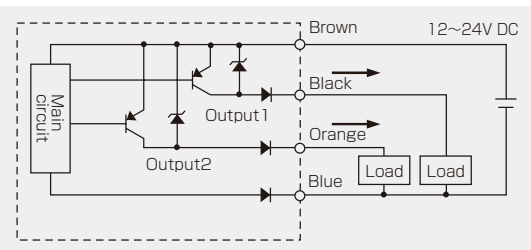

- HPX-AG09 / AG10

NPN open collector output

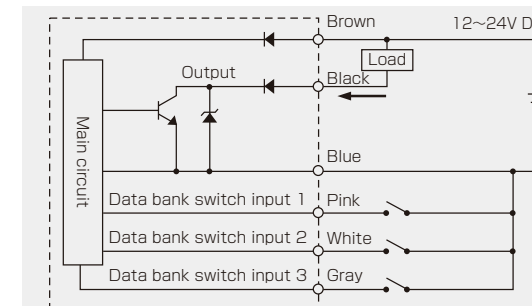

PNP open collector output

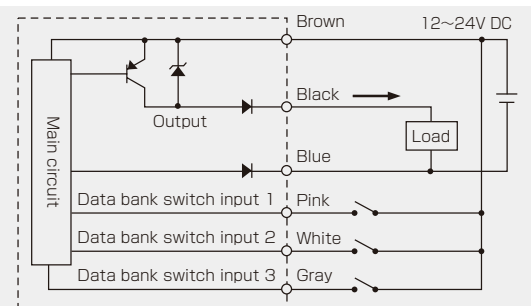

Note: The HPX-AG09-* does not have data bank switch input 3.

HPX-AG

Sensing type

Sensing types	Response time	Maximum display value
High Power	5ms	9999
Normal	1ms	9999
Semi Fast	500µs	5000
Fast	250µs	4000
Semi High Speed	140µs	4000
High Speed	NPN: 50µs PNP: 58µs	4000

Timer type

Timer types	Timer types
No timer	No timer
On-delay	On-delay
Off-delay	Off-delay
One-shot	One-shot
On-delay · One-shot	On-delay · One-shot
On-delay · Off-delay	On-delay · Off-delay
Heartbeat	Heartbeat
Output latch	Output latch

Indication type

Menu	Indication type	Display (green)	Display (red)
nl	Normal display	Preset value	Incoming light level
pcnl	Percent	Preset value	Relative value *
ph	Peak light level	Peak value	Incoming light level
bh	Bottom light level	Bottom value	Incoming light level
ph-bh	Peak and bottom light levels	Peak value	Bottom value

Displayed value shift function

Disable display shift / Enable display shift

Shift amount, shifted value

Monitor sleep mode

Disable monitor sleep / Enable monitor sleep

Display hold time

Display hold time	Display hold time
Hold time 2s	Hold time 2s
Hold time 10s	Hold time 10s
Permanent hold	Permanent hold

Key lock type

Key lock type	Key lock type
Lock all keys	Lock all keys
Block all key operations except for tuning	Block all key operations except for tuning

Display inversion

Display inversion	Display inversion
Do not invert	Do not invert
Invert	Invert

Initialization

Initialization	Initialization
Do not initialize	Do not initialize
Initialize	Initialize

Alarm output *1

Alarm output *1	Alarm output *1
No selection	No selection
Light level drop alarm output	Light level drop alarm output
Stability safety margin alarm output	Stability safety margin alarm output

Data bank *1

Data bank *1	Data bank *1
Designation of data bank number by external input	Designation of data bank number by external input
Data bank 7 selection	Data bank 7 selection
Data bank 6 selection	Data bank 6 selection
...	...
Data bank 0 selection	Data bank 0 selection

Synchronous external input *1

Synchronous external input *1	Synchronous external input *1
Off-enable	Off-enable
On-enable	On-enable

HPX-EG

Sensing type

Sensing types	Response time	Maximum display value
Normal	1ms	4000
Semi Fast	500µs	2000
Fast	250µs	1000

Timer type

Timer types	Timer types
No timer	No timer
On-delay	On-delay
Off-delay	Off-delay

Indication type

Menu	Indication type	Display (green)	Display (red)
nl	Normal display	Preset value	Incoming light level
pcnl	Stability safety margin indication	p	Stability safety margin

Monitor sleep mode

Monitor sleep mode	Monitor sleep mode
Disable monitor sleep	Disable monitor sleep
Enable monitor sleep	Enable monitor sleep

Display inversion

Display inversion	Display inversion
Do not invert	Do not invert
Invert	Invert

Self Threshold Adjustment(STA)

Timer types	Timer types
STA is disabled	STA is disabled
STA is enabled	STA is enabled

Option

Menu	Automatic sensitivity switching	STA reset upon power-up	EEPROM Storage
Opt 1	<input type="checkbox"/>	<input type="checkbox"/>	<input type="checkbox"/>
Opt 2	<input type="checkbox"/>	<input type="checkbox"/>	<input type="checkbox"/>
Opt 3	<input type="checkbox"/>	<input type="checkbox"/>	<input type="checkbox"/>
Opt 4	<input type="checkbox"/>	<input type="checkbox"/>	<input type="checkbox"/>
Opt 5	<input type="checkbox"/>	<input type="checkbox"/>	<input type="checkbox"/>
Opt 6	<input type="checkbox"/>	<input type="checkbox"/>	<input type="checkbox"/>

Emitter frequency switching

Menu	Emitter frequency switching
Fr-1	Fr-1
Fr-2	Fr-2

Initialization

Initialization	Initialization
Do not initialize	Do not initialize
Initialize	Initialize

*1. This function is indicated only on certain models. For more details on the operation of the HPX-AG08, refer to the user's manual.