

# Solenoid directional valves type DHE

direct operated, high performances, ISO 4401 size 06

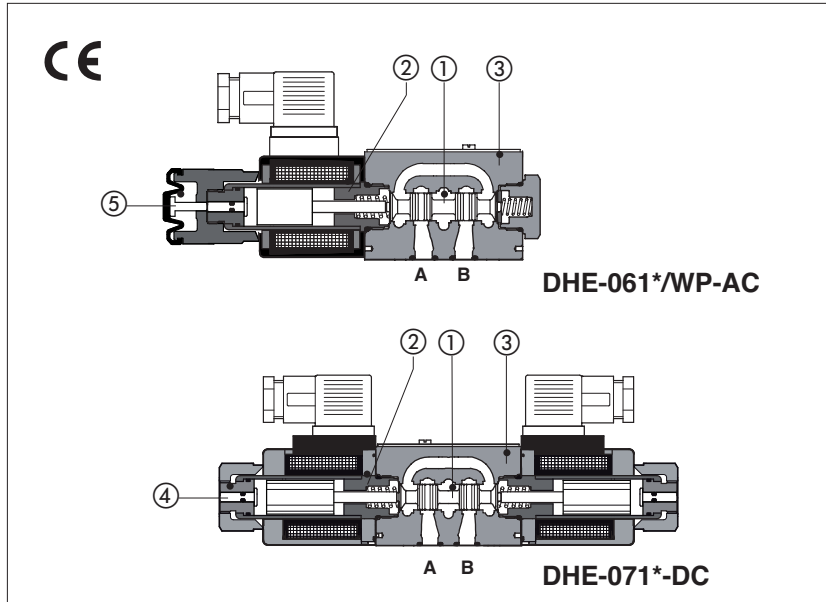

Spool type, two or three position direct operated valves with high performance threaded solenoids certified according to the North American standard **cURus**.

Solenoids ② are made by:

- wet type screwed tube, different for AC and DC power supply, with integrated manual override pin ④
- interchangeable coils, specific for AC or DC power supply, easily replaceable without tools - see section ⑤ for available voltages

Standard coils protection **IP65** optional coils with IP67 AMP Junior Timer or lead wire connections.

Wide range of interchangeable spools ①, see section ②.

The valve body ③ is 3 chamber type made by shell-moulding casting with wide internal passages.

Mounting surface: **ISO 4401 size 06**







Max flow: **80 l/min**

Max pressure: **350 bar**

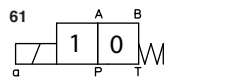
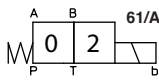
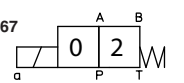
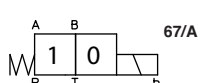
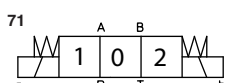
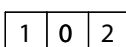
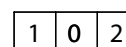
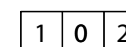
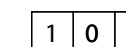
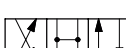
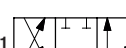
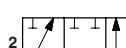
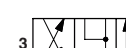
## 1 MODEL CODE

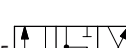
<b>DHE - 0</b>	<b>61</b>	<b>1</b>	<b>/A</b>	<b>-</b>	<b>X</b>	<b>24 DC</b>	<b>**</b>	<b>/*</b>
Directional control valves size 06							Series number	Seals material, see section ③: - = NBR <b>PE</b> = FKM <b>BT</b> = HNBR
Valve configuration, see section ②							Voltage code, see section ⑤	
<b>61</b> = single solenoid, center plus external position, spring centered <b>63</b> = single solenoid, 2 external positions, spring offset <b>67</b> = single solenoid, center plus external position, spring offset <b>71</b> = double solenoid, 3 positions, spring centered <b>75</b> = double solenoid, 2 external positions, with detent								
Spool type, see section ②.								
Options, see note 1 at section ④.								
								<b>00-AC</b> = AC solenoids without coils <b>00-DC</b> = DC solenoids without coils <b>X</b> = without connector See section ④ for available connectors, to be ordered separately Coils with special connectors, see section ⑤ <b>XJ</b> = AMP Junior Timer connector <b>XK</b> = Deutsch connector <b>XS</b> = Lead Wire connection

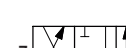
## 2 CONFIGURATIONS and SPOOLS (representation according to ISO 1219-1)

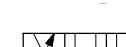
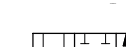
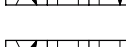
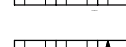
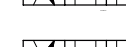
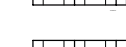
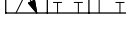
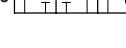
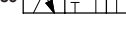
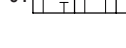
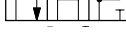
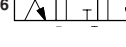
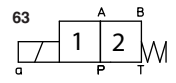
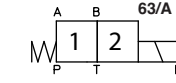
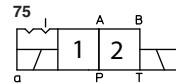
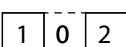
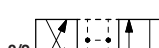
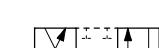
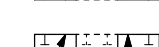
Configurations	Spools	Configurations	Spools
    	                         	  	   

**Note:** see also section ④, note 3, for special shaped spools

(1): spool type 6/7 available only for configuration 61, not available for version /A

(2): not available for configuration 75

**3 MAIN CHARACTERISTICS, SEALS AND HYDRAULIC FLUID** - for other fluids not included in below table, consult our technical office

Assembly position / location	Any position		
Subplate surface finishing	Roughness index Ra 0,4 - flatness ratio 0,01/100 (ISO 1101)		
MTTFd values according to EN ISO 13849	150 years, for further details see technical table P007		
Ambient temperature	Standard execution = -30°C ÷ +70°C /PE option = -20°C ÷ +70°C /BT option = -40°C ÷ +70°C		
Seals, recommended fluid temperature	NBR seals (standard) = -20°C ÷ +60°C, with HFC hydraulic fluids = -20°C ÷ +50°C FKM seals (/PE option) = -20°C ÷ +80°C HNBR seals (/BT option) = -40°C ÷ +60°C, with HFC hydraulic fluids = -40°C ÷ +50°C		
Recommended viscosity	15÷100 mm <sup>2</sup> /s - max allowed range 2.8 ÷ 500 mm <sup>2</sup> /s		
Fluid contamination class	ISO 4406 class 21/19/16 NAS 1638 class 10, in line filters of 25 µm (β <sub>25</sub> ≥75 recommended)		
<b>Hydraulic fluid</b>	<b>Suitable seals type</b>	<b>Classification</b>	<b>Ref. Standard</b>
Mineral oils	NBR, FKM, HNBR	HL, HLP, HLPD, HVLP, HVLDP	DIN 51524
Flame resistant without water	FKM	HFDU, HFDR	ISO 12922
Flame resistant with water	NBR, HNBR	HFC	
Flow direction	As shown in the symbols of table 2		
<b>Operating pressure</b>	Ports P,A,B: <b>350</b> bar; Port T <b>210</b> bar for DC version; <b>160</b> bar for AC version		
Rated flow	See diagrams Q/Δp at section 6		
<b>Maximum flow</b>	<b>80 l/min</b> , see operating limits at section 7		

**3.1 Coils characteristics**

Insulation class	<b>H</b> (180°C) for DC coils <b>F</b> (155°C) for AC coils Due to the occurring surface temperatures of the solenoid coils, the European standards EN ISO 13732-1 and EN ISO 4413 must be taken into account
Protection degree to DIN EN 60529	<b>IP 65</b> (with connectors 666, 667, 669 correctly assembled)
Relative duty factor	100%
Supply voltage and frequency	See electric feature 5
Supply voltage tolerance	± 10%
Certification	<b>cURus</b> North American Standard

**4 NOTES**

**1 Options**

- A** = Solenoid mounted at side of port B (only for single solenoid valves). In standard versions, solenoid is mounted at side of port A.  
**WP** = prolonged manual override protected by rubber cap.

 The manual override operation can be possible only if the pressure at T port is lower than 50 bar - see section 12.

**WPD/HE-DC** = (only for DHE-DC) manual override with detent, to be ordered separately, see tab. K150

**L1, L2, L3** = (only for DHE-DC) device for switching time control, installed in the valve solenoid, see section 9.

For spools 4 and 4/8 only device L3 is available.

**FI, FV** = with proximity or inductive position switch for monitoring spool position: see tab. E110.

**MV, MO** = auxiliary hand lever positioned vertically (MV) or horizontally (MO). For available configuration and dimensions see table E138.

**2 Type of electric/electronic connector DIN 43650**, to be ordered separately

**666** = standard connector IP-65, suitable for direct connection to electric supply source.

**667** = as 666, but with built-in signal led.

**669** = with built-in rectifier bridge for supplying DC coils by alternate current (AC 110V and 230V - I<sub>max</sub> 1A).

**E-SD** = electronic connector which eliminates electric disturbances when solenoid valves are de-energized.

**3 Spools**

- spools type **0** and **3** are also available as **0/1** and **3/1** with restricted oil passages in central position, from user ports to tank.
- spools type **1, 4, 5** and **58** are also available as **1/1, 4/8, 5/1** and **58/1**. They are properly shaped to reduce water-hammer shocks during the switching.
- spools type **1, 1/2, 3, 8** are available as **1P, 1/2P, 3P, 8P** to limit valve internal leakages.
- Other types of spools can be supplied on request.

**5 ELECTRIC FEATURES**

External supply nominal voltage ± 10%	Voltage code	Type of connector	Power consumption (2)	Code of spare coil DHE	
12 DC	<b>12 DC</b>	666 or 667	30 W	COE-12DC	
14 DC	<b>14 DC</b>			COE-14DC	
24 DC	<b>24 DC</b>			COE-24DC	
28 DC	<b>28 DC</b>			COE-28DC	
48 DC	<b>48 DC</b>			COE-48DC	
110 DC	<b>110 DC</b>			COE-110DC	
125 DC	<b>125 DC</b>			COE-125DC	
220 DC	<b>220 DC</b>			COE-220DC	
110/50 AC	<b>110/50/60 AC</b>			58 VA (3)	COE-110/50/60AC (1)
230/50 AC	<b>230/50/60 AC</b>				COE-230/50/60AC (1)
115/60 AC	<b>115/60 AC</b>	80 VA (3)	COE-115/60AC		
230/60 AC	<b>230/60 AC</b>		COE-230/60AC		
110/50 AC - 120/60 AC	<b>110 RC</b>	669	30 W	COE-110RC	
230/50 AC - 230/60 AC	<b>230 RC</b>			COE-230RC	

(1) Coil can be supplied also with 60 Hz of voltage frequency: in this case the performances are reduced by 10 ÷ 15% and the power consumption is 52 VA.

(2) Average values based on tests performed at nominal hydraulic condition and ambient/coil temperature of 20°C.

(3) When solenoid is energized, the inrush current is approx 3 times the holding current.

**6 Q/ΔP DIAGRAMS** based on mineral oil ISO VG 46 at 50°C

Flow direction Spool type	Flow direction				
	P→A	P→B	A→T	B→T	P→T
0, 0/1	A	A	C	C	D
1, 1/1, 1/9	D	C	C	C	
3, 3/1	D	D	A	A	
4, 4/8, 5, 5/1, 49, 58, 58/1, 94	F	F	G	C	E
1/2, 0/2	D	D	D	D	
6, 7, 16, 17	D	D	D	D	
8	A	A	E	E	
2	D	D			
2/2	F	F			
09, 19, 90, 91	E	E	D	D	
39, 93	F	F	G	G	

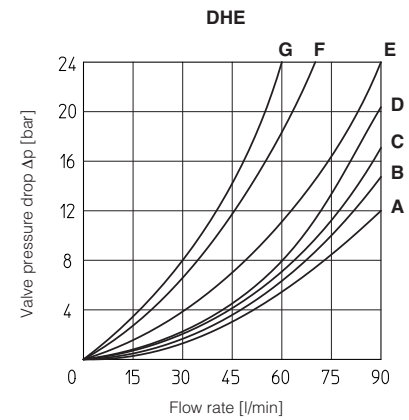

**7 OPERATING LIMITS** based on mineral oil ISO VG 46 at 50°C

The diagrams have been obtained with warm solenoids and power supply at lowest value ( $V_{nom} - 10\%$ ). The curves refer to application with symmetrical flow through the valve (i.e. P→A and B→T). In case of asymmetric flow and if the valves have the devices for controlling the switching times the operating limits must be reduced.

Curve	Spool type	
	AC	DC
A	1, 1/2, 8	0, 0/1, 1, 1/2, 3, 8
B	0, 0/1, 0/2, 1/1, 1/9, 3	0/2, 1/1, 6, 7, 1/9, 19
C	3, 3/1, 6, 7	3/1, 4, 4/8, 5, 5/1, 16, 17, 19, 39, 49, 58, 58/1, 09, 90, 91, 93, 94
D	4, 4/8, 5, 5/1, 16, 17, 19, 39, 58, 58/1, 09, 90, 91, 93, 94	2, 2/2
E	2, 2/2	-

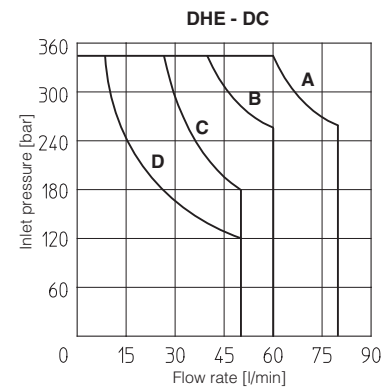
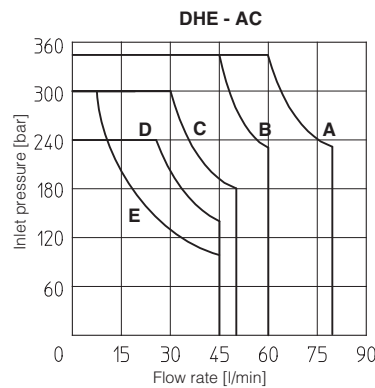

**8 SWITCHING TIMES** (average values in msec)

Test conditions: - 36 l/min; 150 bar  
- nominal voltage  
- 2 bar of counter pressure on port T  
- mineral oil: ISO VG 46 at 50°C

The elasticity of the hydraulic circuit and the variations of the hydraulic characteristics and temperature affect the response time.

Valve	Switch-on AC	Switch-off AC	Switch-on DC	Switch-off DC
DHE	10 - 25	20 - 40	30 - 50	15 - 25
DHE*/L1	—	—	60	60
DHE*/L2	—	—	80	80
DHE*/L3	—	—	150	150

**9 DEVICES FOR THE SWITCHING TIME CONTROL**

These devices are used to control the valve's switching time (only for DC version) and therefore reduce the hammering shocks in the hydraulic circuit.

Options L1, L2, L3 control the switching time in both moving directions of the valve spool by means of calibrated restrictors installed in the solenoid anchor.

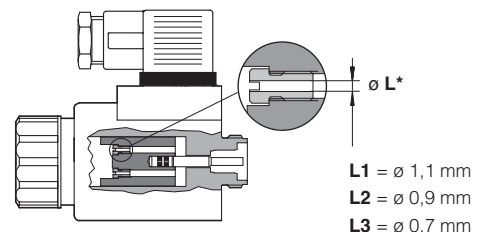

**10 SWITCHING FREQUENCY**

Valve	AC (cycles/h)	DC (cycles/h)
DHE + 666 / 667	7200	15000

**11 COIL WITH SPECIAL CONNECTORS** only for voltage supply 12, 14, 24, 28 Vdc

AMP Junior timer connector	Deutsch connector DT-04-2P	Lead Wire connection
<p><b>Options -XJ</b> Coil type COEJ AMP Junior Timer connector Protection degree IP67</p>	<p><b>Options -XK</b> Coil type COEK Deutsch connector DT-04-2P male Protection degree IP67</p>	<p><b>Options -XS</b> Coil type COES Lead Wire connection Cable length = 180 mm</p>

Note: for the electric characteristics refer to standard coils features - see section 5

**12 DIMENSIONS [mm]**

**ISO 4401 : 2005**

**Mounting surface: 4401-03-02-0-05**

Fastening bolts: 4 socket head screws:

M5x30 class 12.9

Tightening torque = 8 Nm

Seals: 4 OR 108

Ports P,A,B,T: Ø = 7.5 mm (max)

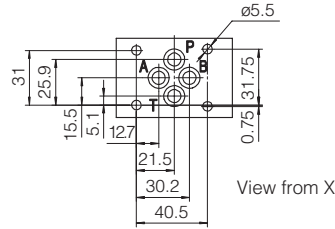

**P** = PRESSURE PORT  
**A, B** = USE PORT  
**T** = TANK PORT

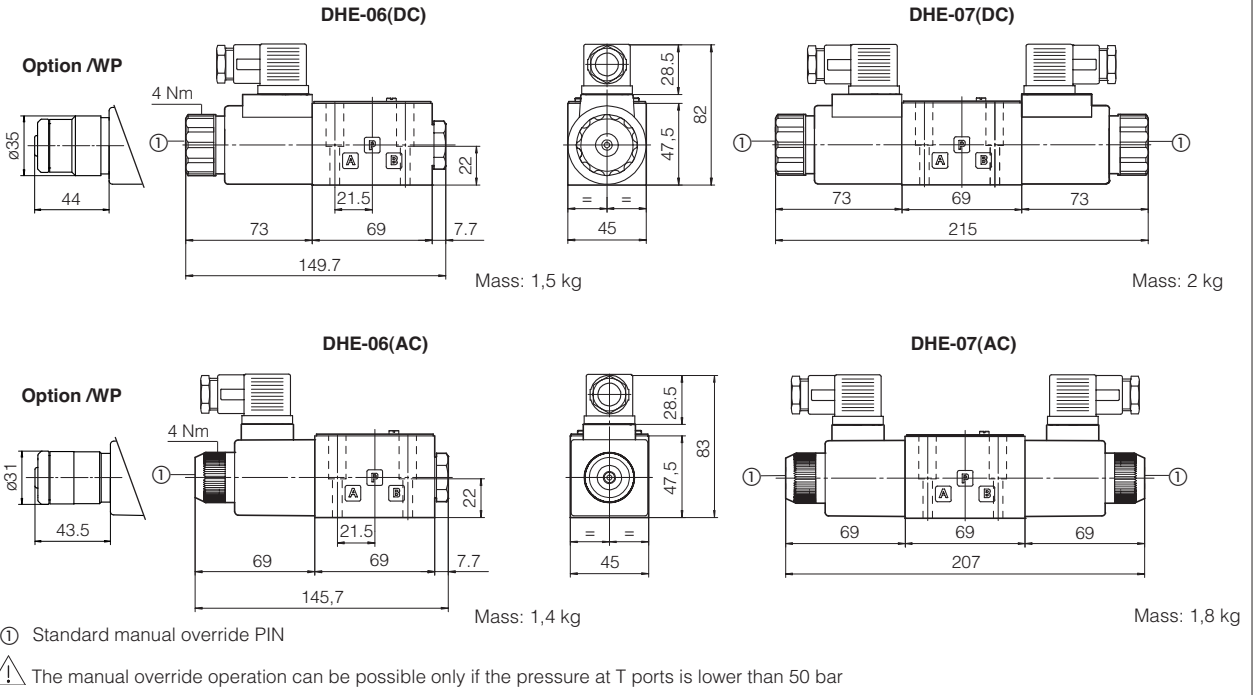

Overall dimensions refer to valves with connector 666

**13 PLUG-IN RESTRICTOR** (to be ordered separately)

The use of plug-in restrictors in valve's ports P or A or B may be necessary in case of particular conditions as long flexible hoses or the presence of accumulators which could cause at the valve switching instantaneous high flow peaks over the max valve's operating limits.

Ordering code: **PLUG H** - **\*\***  
**08, 10, 12, 15** calibrated orifice diameter in tenths of mm  
 Example PLUG-H-12 = orifice diameter **1,2 mm**  
 Other orifice dimensions are available on request

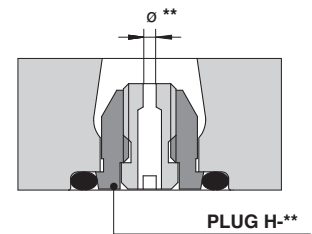

**14 ELECTRIC CONNECTORS ACCORDING TO DIN 43650** (to be ordered separately)

666, 667 (for AC or DC supply)		669 (for AC supply)		CONNECTOR WIRING		
				<b>666, 667</b> 1 = Positive ⊕ 2 = Negative ⊖ ⊕ = Coil ground		<b>669</b> 1,2 = Supply voltage Vac 3 = Coil ground
<b>SUPPLY VOLTAGES</b>						
<b>666</b> All voltages		<b>667</b> 24 AC or DC 110 AC or DC 220 AC or DC		<b>669</b> 110/50 AC 110/60 AC 230/50 AC 230/60 AC		

Note: for electronic connectors type **E-SD**, see tab. K500

**15 MOUNTING SUBPLATES**

Model	Ports location	GAS Ports A-B-P-T	Ø Counterbore [mm] A-B-P-T	Mass [kg]
BA-202	Ports A, B, P, T underneath;	3/8"	-	1,2
BA-204	Ports P, T underneath; ports A, B on lateral side	3/8"	25,5	1,8
BA-302	Ports A, B, P, T underneath	1/2"	30	1,8

The subplates are supplied with 4 fastening bolts M5x50. Also available are multi-station subplates and modular subplates. For further details see table K280.