

Industrial Valves

Ball Valves

LIQUIfit®

Needle and Butterfly Valves

Axial Valves



PARKER LEGRIS Industrial Connector Systems

Products are available from:

MARYLAND METRICS

P.O. Box 261 Owings Mills, MD 21117 USA email: sales@mdmetric.com

ph: (410)358-3130 (800)638-1830 fx: (410)358-3142 (800)872-9329

web: <http://mdmetric.com> RFQ form: <http://mdmetric.com/rfq.htm>

How to order: Please preface each PARKER LEGRIS Catalog part number with 'R053-' Example: R053-3175 04 10



Industrial Valves

Ball Valves, Universal Series

[P. 6-8]



Fluids: compressed air, slightly corrosive fluids

Materials: nickel-plated forged brass

Pressure: 40 bar

Temperature: -20°C to +80°C

DN : 4 mm to 40 mm

Ball Valves, Universal Series, Vented

[P. 6-13]



Fluids: compressed air, slightly corrosive fluids

Materials: nickel-plated forged brass

Pressure: 40 bar

Temperature: -20°C to +80°C

DN : 4 mm to 23 mm

Ball Valves, Universal Series, Lockable

[P. 6-15]



Fluids: compressed air, slightly corrosive fluids

Materials: nickel-plated forged brass, galvanised steel and epoxy locking system

Pressure: 40 bar

Temperature: -20°C to +80°C

DN : 4 mm to 23 mm

Ball Valves, Universal Customised Series

[P. 6-9]



Fluids: compressed air, many fluids

Materials: nickel-plated forged brass, choice of seal material (NBR, EPDM, FKM, PTFE...)

Pressure: 40 bar

Temperature: -20°C to +100°C

DN : 4 mm to 40 mm

Ball Valves, Universal Light Series

[P. 6-16]



Fluids: compressed air, slightly corrosive fluids

Materials: forged brass or nickel-plated forged brass

Pressure: 12 bar

Temperature: -20°C to +80°C

DN : 4 mm to 13 mm

Ball Valves, DVGW Series

[P. 6-20]



Fluids: compressed air, water, gas

Materials: nickel-plated forged brass

Pressure: 40 bar

Temperature: -40°C to +170°C

DN : 8 mm to 50 mm

Ball Valves, Standard Series

[P. 6-22]



Fluids: compatible fluids

Materials: nickel or chromium-plated brass with PTFE seal

Pressure: 35 bar

Temperature: -20°C to +130°C

DN : 8 mm to 100 mm

Ball Valves, Stainless Steel Series

[P. 6-28]



Fluids: all fluids

Materials: 316L stainless steel

Pressure: 65 bar

Temperature: -20°C to +150°C

DN : 8 mm to 50 mm

Ball Valves, Stainless Steel Light Series

[P. 6-28]



Fluids: all fluids

Materials: 316L stainless steel

Pressure: 65 bar

Temperature: -20°C to +120°C

DN : 4 mm to 10 mm

Industrial Valves

Ball Valves, High Pressure Series

[P. 6-30]



Fluids: lubricants, gases
Materials: zinc-plated brass
Pressure: 300 bar
Temperature: -15°C to +80°C
 $\overline{\text{DN}}$: 7 mm to 13 mm

Ball Valves, Mini Series

[P. 6-32]



Fluids: compressed air
Materials: technical polymer
Pressure: 10 bar
Temperature: -20°C to +80°C
 $\overline{\text{DN}}$: 4 mm to 12 mm

Ball Valves, LIQUIfit®

[P. 6-34]



Fluids: water, beverages, CO₂, inert gases
Materials: polypropylene, EPDM seal
Pressure: 10 bar
Temperature: -15°C to +100°C
Tube Ø: 1/4" and 3/8"

Needle Valves, Brass

[P. 6-37]



Fluids: compressed air, industrial fluids
Materials: shot-blasted forged brass, nickel-plated
Pressure: 120 bar
Temperature: -20°C to +100°C
 $\overline{\text{DN}}$: 4 mm to 10 mm

Needle Valves, Stainless Steel

[P. 6-41]



Fluids: all fluids
Materials: 316L stainless steel
Pressure: 400 bar
Temperature: -20°C to +180°C
 $\overline{\text{DN}}$: 3 mm to 6 mm

Butterfly Valves

[P. 6-42]



Fluids: compressed air, abrasive fluids
Materials: shot-blasted forged brass, nickel-plated
Pressure: 16 bar
Temperature: -20°C to +80°C
 $\overline{\text{DN}}$: 6 mm to 18 mm

Axial Valves

[P. 6-45]



Fluids: compressed air, industrial fluids
Materials: nickel-plated brass
Pressure: 10 bar
Temperature: -20°C to +135°C
Threads : 3/8" to 2"

Ball Valve Range

Universal and Universal Customised Series

In-Line

0402 2/2 Page 6-10
0401 2/2 Page 6-10
0400 2/2 Page 6-10
0411 2/2 Page 6-10
0414 2/2 Page 6-10



In-Line with Fixing Holes and Panel Mounting

0446 2/2 Page 6-11
6402 2/2 Page 6-11
6401 2/2 Page 6-11



Right-Angled

0472 2/2 Page 6-11
0471 2/2 Page 6-11



In-Line, 3-Way

0482 3/3 Page 6-12
0483 3/3 Page 6-12



In-Line, 3-Way with Fixing Holes and Panel Mounting

0448 3/3 Page 6-12
0452 3/2 Page 6-12



Universal Series, Vented

In-Line

0489 3/2 Page 6-13
0449 3/2 Page 6-13
0469 3/2 Page 6-13



Right-Angled

0462 3/2 Page 6-14
0461 3/2 Page 6-14



Universal Lockable Series

In-Line

0432 2/2 Page 6-15



In-Line, Vented

0439 3/2 Page 6-15
0436 3/2 Page 6-15
0437 3/2 Page 6-15



In-Line, 3-Way

0438 3/2 Page 6-15



Universal Light Series

In-Line

0492 2/2 Page 6-17
0491 2/2 Page 6-17
0490 2/2 Page 6-17



In-Line, Vented

0494 2/2 Page 6-18



In-Line with Square Stem

0497 2/2 Page 6-18
0496 2/2 Page 6-18



Ball Valve Range

DVGW Series

In-Line

BVG4-L

2/2
Page 6-21



BVGT4-L

2/2
Page 6-21



Standard Series

In-Line

4902

2/2
Page 6-23



BVGT4-C

2/2
Page 6-23



Compact

4991

2/2
Page 6-23



4992

2/2
Page 6-23



In-Line, Lockable

BVG4-LOCK

2/2
Page 6-24



In-Line, Lockable, Vented

BVG4P-LOCK

3/2
Page 6-24



Stainless Steel Series

In-Line

4832

Mountable and dismountable
2/2
Page 6-29



4812

Mountable
2/2
Page 6-29



4810

One-Piece Construction
2/2
Page 6-29



0465

Light Series
2/2
Page 6-29



High Pressure Series

In-Line

4402

2/2
Page 6-31



Mini Series

In-Line

7910

2/2
Page 6-33



7911

2/2
Page 6-33



In-Line, Vented and Accessories

7913

3/2
Page 6-33



7914

3/2
Page 6-33



7000

Page 6-33



LIQUIFIT®

In-Line

4020

2/2
Page 6-35



4021

2/2
Page 6-35



4023

2/2
Page 6-35



Right-Angled

4022

2/2
Page 6-35



Accessories

3130

Page 6-35



Ball Valves, Universal Series

This range of valves has patented **seal wear compensating** technology for **reliable** and **durable** sealing, **protecting** any system whether under pressure or **vacuum**.

Product Advantages

Durability & Reliability

- Automatic seal wear compensation for long-term reliability
- Robust, corrosion-resistant materials
- 100% leak-tested in production
- Date coding to guarantee quality and traceability

Versatility & Performance

- Ideal for ensuring the performance of pneumatic circuits
- Customised valves for all special applications
- Unequalled performance under vacuum
- Smooth operation thanks to self-lubricating seals
- Large range of working pressures and temperatures
- Lever can be repositioned and replaced
- Many configurations to satisfy all system requirements



Applications

- Pneumatics
- Vacuum
- Transportation
- Packaging
- Textile
- Sawmill
- Rubber & Plastics

Technical Characteristics

Compatible Fluids	Industrial fluids						
Working Pressure	Vacuum to 40 bar						
Working Temperature	-20°C to + 80°C						

Tightening Torques	Threads	G1/8	G1/4	G3/8	G1/2	G3/4	G1	
	daN.m	0.10 to 0.20	0.10 to 0.20	0.15 to 0.25	0.20 to 0.35	0.50 to 0.70	0.50 to 0.70	
	Threads	G1¼	G1½	G2				
	daN.m	0.40 to 0.60	0.80 to 1.20	0.80 to 1.20				

Reliable performance is dependent upon the type of fluid conveyed, component materials and tubing being used.
Guaranteed for use with a vacuum of 755 mm Hg (99 % vacuum).

Component Materials

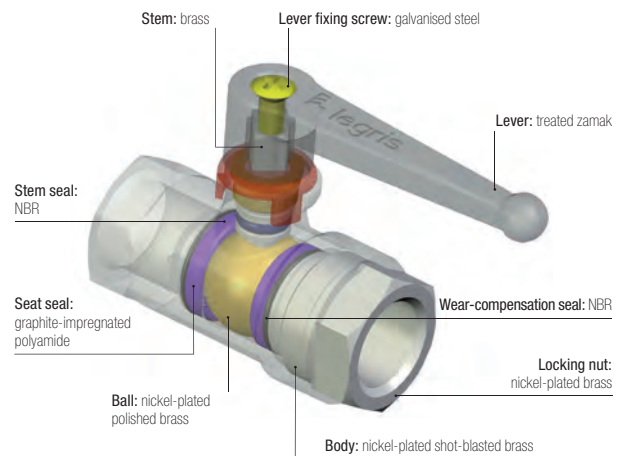

Silicone-free

Regulations

- DI: 97/23/EC (module PED A - diameters greater than 25 mm)
- DI: 2006/42/EC (Machinery Directive)
- DI: 2002/95/EC (RoHS)
- RG: 1907/2006 (REACH)

Universal Series

Installation Options

Lockable Valves

Our lockable ball valves have been developed in order to prevent potentially dangerous consequences caused by unintended operation. Lockable in different positions, this range meets international safety requirements, such as ISO 4414.

The valves are lockable:

- at one point: models 0432 and 0439
- at three points: models 0437 and 0438

Vented Valves

To stop fluid circulation and vent the circuit, 2 venting systems are provided:

- with threaded exhaust, to allow discharge of downstream media
- with pin-hole vent, for applications with no special discharge requirement

Fluid flow direction is indicated by an arrow on the valve body.

Mountable Valves

On steel plate:

- bulkhead fixing
- complete valve below bulkhead

On frame:

- assemble with bolts

On wooden panel:

- assemble with woodscrews

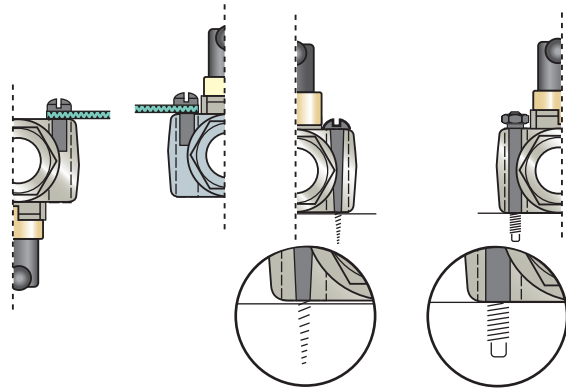

Universal Customised Valve Series

Based on the standard components of the universal series, this range allows the valve to be adapted to specific needs. There are 6 product versions available on request.

Product Codes

Valve type	0402 04 10 22		
0400	DN	Thread	Suffix
0401			
0402	04 = 4 mm	10 = 1/8"	20 = blue/red
...	05 = 5 mm	13 = 1/4"	22 = green/blue
	26 = yellow/yellow
	40 = 40 mm	48 = 2"	27 = blue/green
			30 = white/red
			32 = white/green

Identification

Each series may be easily identified by a colour marking on the lever.



Suffix Specification

Identification		Body		Lever			Ball		Stem and Wear-Compensation Seals			Seat Seals			Application Examples
Suffix on the body	Colour bands on the lever	Nickel-plated brass	Chemical nickel-plated brass	Standard	Nickel-plated brass	Chemical nickel-plated brass	Nickel-plated polished brass	Chemical nickel-plated brass	EPDM	FKM	PTFE white	Rilsan: graphite-impregnated	Filled PTFE	PTFE white	
20	Blue/Red	•		•			•			•		•			Hydrocarbons
22	Green/Blue	•		•				•		•			•		Industrial fluids and high temperature
26*	Yellow/Yellow	•			•			•			• olive			•	Corrosive liquids or high temperature
27	Blue/Green		•			•		•		•			•		Industrial fluids and/or harsh environments
30**	White/Red	•		•			•		•			•			Gaseous oxygen circuits
32	White/Green	•		•			•		•				•		Water and steam circuits



*degreased **oxygen-compatible grease

A usage chart in this chapter shows which type of valve to use according to the fluid being conveyed.

Universal and Universal Customised Series

0402 2/2 In-Line Ball Valve, Female BSPP Thread

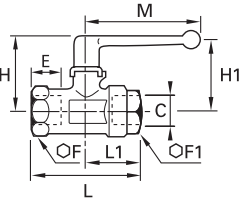



		Nickel-plated brass, NBR	C	DN		E	F	F1	H	H1	L	L1	M	kg
			G1/8	4	0402 04 10	8	-	14	35	29	44	25	48	0.094
			7	0402 07 10	8	19	19	38	31	51	27	48	0.166	
			G1/4	7	0402 07 13	12	19	19	38	31	53	28	48	0.156
			G3/8	10	0402 10 17	12	24	24	45	43	59	31	69	0.244
			G1/2	13	0402 13 21	15	27	27	47	44	67	34	69	0.292
			G3/4	20	0402 20 27	16.5	32	38	63	54	80	39	108	0.655
			G1	23	0402 23 34	19	41	46	67	57	94	47	108	1.036
			G1¼	32	0402 32 42*	21.5	55	60	97	115	112	59	180	2.467
			G1½	32	0402 32 49*	22	55	60	97	115	120	62	180	2.340
			G2	40	0402 40 48*	22	55	55	104	-	111	55	190	2.445
			G2	40	0402 40 48*	26	70	70	104	-	122	61	190	2.614

*Models with CE marking
Maximum working pressure: 40 bar

0401 2/2 In-Line Ball Valve, Male/Female BSPP Thread

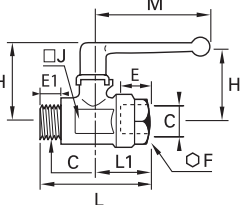



		Nickel-plated brass, NBR	C	DN		E	E1	F	H	H1	J	L	L1	M	kg
			G1/8	4	0401 04 10	8	7	14	35	29	14	45	25	48	0.094
			5	0401 05 10	8	7	19	38	31	19	51	27	48	0.160	
			G1/4	7	0401 07 13	12	9	19	38	31	19	52	28	48	0.150
			G3/8	10	0401 10 17	12	11	24	45	43	24	58	31	69	0.234
			G1/2	13	0401 13 21	15	12	27	47	44	27	66	34	69	0.286
			G3/4	18	0401 18 27	16.5	12	38	63	54	39	79	39	108	0.652
			G1	23	0401 23 34	19	15	46	67	57	48	91	47	108	0.952
			G1¼	32	0401 32 42*	21.5	18	60	97	115	55	113	59	108	2.385

*Models with CE marking
Maximum working pressure: 40 bar

0400 2/2 In-Line Ball Valve, Male BSPP Thread

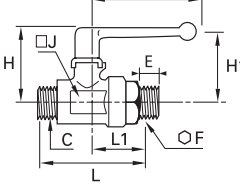



		Nickel-plated brass, NBR	C	DN		E	F	H	H1	J	L	L1	M	kg
			G1/8	4	0400 04 10	7	14	35	29	14	45	25	48	0.094
			G1/4	7	0400 07 13	9	19	38	31	19	60	36	48	0.166
			G3/8	10	0400 10 17	11	24	45	43	24	70	43	69	0.252
			G1/2	13	0400 13 21	12	27	47	44	27	78	45	69	0.324
			G3/4	18	0400 18 27	12	38	63	54	39	90	50	108	0.714

Maximum working pressure: 40 bar

0411 2/2 In-Line Ball Valve with Connections for Use with Steel Tube

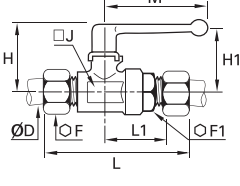



		Nickel-plated brass, NBR	ØD	DN		F	F1	H	H1	J	L	L1	M	kg
			6	4	0411 04 06	14	19	38	31	19	76	30	48	0.073
			8	6	0411 06 08	17	19	38	31	19	77	30	48	0.095
			10	7	0411 07 10	19	19	38	31	19	78	31	48	0.100
			12	10	0411 10 12	22	24	45	43	24	85	36	69	0.110

Maximum working pressure: 40 bar

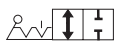
0414 2/2 In-Line Ball Valve with Compression Connections

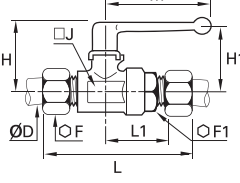





		Nickel-plated brass, NBR	ØD	DN		F	F1	H	H1	J	L	L1	M	kg
			6	4	0414 04 06	13	19	38	31	19	72	31	48	0.177
			8	6	0414 06 08	14	19	38	31	19	74	30	48	0.180
			10	7	0414 07 10	19	19	38	31	19	78	31	48	0.210
			12	10	0414 10 12	22	24	45	43	24	86	36	69	0.308

Maximum working pressure: 40 bar

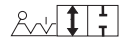
Universal and Universal Customised Series

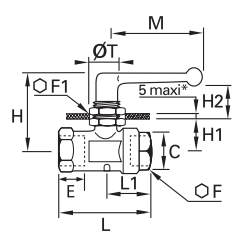

0446 2/2 In-Line Panel-Mountable Ball Valve, Female BSPP Thread



	Nickel-plated brass, NBR 	C	DN		E	F	F1	H	H1	H2	L	L1	M	ØT	kg
		G1/8	4	0446 04 10	8	14	22	37	14	12	44	25	48	16.5	0.112
		G1/4	7	0446 07 13	12	19	24	45	19	14	53	28	48	20.5	0.188
		G3/8	10	0446 10 17	12	24	27	50	21	21	59	31	69	20.5	0.294
		G1/2	13	0446 13 21	15	27	27	51	23	21	67	34	69	20.5	0.338
Maximum working pressure: 20 bar *For G1/8 version, maximum panel thickness = 3 mm															

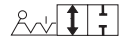

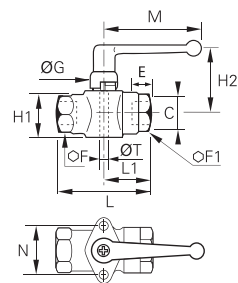
6402 2/2 In-Line Ball Valve for Screw Fixing, Female BSPP Thread



	Nickel-plated brass, NBR 	C	DN		E	F	F1	G	H1	H2	L	L1	M	N	ØT	kg
		G1/8	4	6402 04 10	8	14	14	18	18	30	44	25	48	25	4x70	0.132
		G1/4	7	6402 07 13	12	19	19	19	24	31	53	28	48	31	5x80	0.216
		G3/8	10	6402 10 17	12	24	24	20	30	45	59	31	69	31	5x80	0.324
		G1/2	13	6402 13 21	15	27	27	20	34	47	67	34	69	34	6x100	0.404
		G3/4	20	6402 20 27	16.5	32	38	27	44	52	80	39	108	43	8x125	0.830
G1	23	6402 23 34	19	41	46	27	53	56	94	47	108	51	8x125	1.290		
Maximum working pressure: 40 bar																

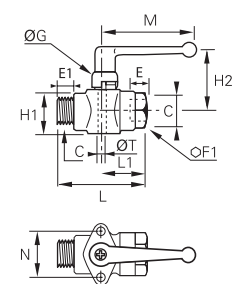

6401 2/2 In-Line Ball Valve for Screw Fixing, Male/Female BSPP Thread



	Nickel-plated brass, NBR 	C	DN		E	E1	F	G	H1	H2	L	L1	M	N	ØT	kg
		G1/8	4	6401 04 10	8	7	14	18	18	30	45	25	48	25	4x70	0.127
		G1/4	7	6401 07 13	12	9	19	19	24	31	52	28	48	31	5x80	0.212
		G3/8	10	6401 10 17	12	11	24	20	30	45	58	31	69	31	5x80	0.306
		G1/2	13	6401 13 21	15	12	27	20	34	47	67	34	69	34	6x100	0.394
Maximum working pressure: 40 bar																

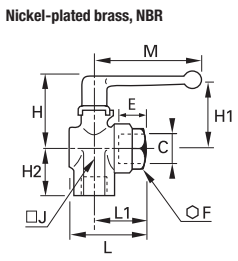

0472 2/2 Right-Angled Ball Valve, Female BSPP Thread

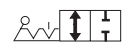

	Nickel-plated brass, NBR 	C	DN		E	F	H	H1	H2	J	L	L1	M	kg	
		G1/8	4	0472 04 10	8	14	35	29	18	14	34	25	48	0.096	
			6	0472 06 10	8	19	38	31	20	22	37	27	48	0.183	
		G1/4	6	0472 06 13	12	19	38	31	24	22	38	28	48	0.191	
		G3/8	9	0472 09 17	12	24	45	43	27	25	46	31	69	0.260	
		G1/2	12	0472 12 21	15	27	47	44	33	29	49	34	69	0.312	
		G3/4	18	0472 18 27	16.5	38	59	51	40	39	60	39	108	0.704	
		G1	23	0472 23 34	19	46	63	55	47	48	72	47	108	1.062	
Maximum working pressure: 20 bar															

0471 2/2 Right-Angled Ball Valve, Male/Female BSPP Thread

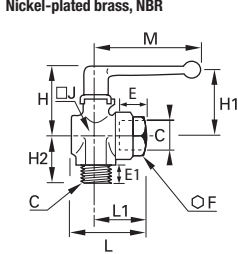

	Nickel-plated brass, NBR 	C	DN		E	E1	F	H	H1	H2	J	L	L1	M	kg
		G1/8	4	0471 04 10	8	7	14	35	29	19	14	34	25	48	0.096
			6	0471 06 10	8	7	19	38	31	22	22	37	27	48	0.182
		G1/4	6	0471 06 13	12	9	19	38	31	25	22	38	28	48	0.187
		G3/8	9	0471 09 17	12	11	24	45	43	28	25	46	31	69	0.256
		G1/2	12	0471 12 21	15	12	27	47	44	32	29	49	34	69	0.300
		G3/4	18	0471 18 27	16.5	12	38	59	51	37	39	60	39	108	0.682
		G1	23	0471 23 34	19	15	46	63	55	44	48	72	47	108	1.020
Maximum working pressure: 20 bar															

Universal and Universal Customised Series

0482 3/3 Right-Angle Ported Ball Valve, Female BSPP Thread

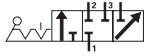

Nickel-plated brass, NBR

C	DN		E	F	H	H1	H2	J	L	L1	M	kg
G1/8	4	0482 04 10	8	14	35	29	18	14	44	25	48	0.103
G1/4	6	0482 06 13	12	19	38	31	24	22	53	28	48	0.200
G3/8	9	0482 09 17	12	24	45	43	27	25	59	31	69	0.284
G1/2	12	0482 12 21	15	27	47	44	33	29	67	34	69	0.346
G3/4	18	0482 18 27	16.5	38	59	51	40	39	80	39	108	0.742
G1	23	0482 23 34	19	46	63	55	47	48	94	47	108	1.160

Maximum working pressure: 20 bar

Closed

0483 3/3 Right-Angle Ported Ball Valve without Closed Position, Female BSPP Thread

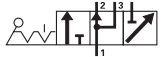

Nickel-plated brass, NBR

C	DN		E	F	H	H1	H2	J	L	L1	M	kg
G1/8	4	0483 04 10	8	14	35	29	18	14	44	25	48	0.102
G1/4	6	0483 06 13	12	19	38	31	24	22	53	28	48	0.196
G3/8	9	0483 09 17	12	24	45	43	27	25	59	31	69	0.278
G1/2	12	0483 12 21	15	27	47	44	33	29	67	34	69	0.340
G3/4	18	0483 18 27	16.5	38	59	51	40	39	80	39	108	0.716
G1	23	0483 23 34	19	46	63	55	47	48	94	47	108	1.066

Maximum working pressure: 20 bar

0448 3/2 Panel-Mountable Right-Angled Ball Valve, Female BSPP Thread

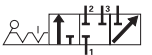

Nickel-plated brass, NBR

C	DN		E	F	F1	H	H1	H2	H3	J	L	L1	M	ØT	kg
G1/8	4	0448 04 10	8	14	22	37	14	18	12	14	44	25	48	16.5	0.126
G1/4	6	0448 06 13	12	19	24	45	19	24	14	22	53	28	48	20.5	0.230
G3/8	9	0448 09 17	12	24	27	50	21	27	21	25	59	31	69	20.5	0.328
G1/2	12	0448 12 21	15	27	27	51	23	33	21	29	67	34	69	20.5	0.392

Maximum working pressure: 20 bar
*For G1/8 version: maximum panel thickness = 3 mm

Closed

0452 3/2 Panel-Mountable Equal Plane Ball Valve, Female BSPP Thread



Nickel-plated brass, NBR

C	DN		E	F	F1	H	H1	H2	J	K	L	ØT	kg
G1/8	4	0452 04 10	8	14	22	39	10	8	16	18	25	19	0.130
G1/4	6	0452 06 13	12	19	24	40	11	11	23	24	28	20	0.206

Maximum working pressure: 20 bar

Universal Series, Vented

0489 3/2 In-Line Vented Ball Valve, Female BSPP and Metric Thread

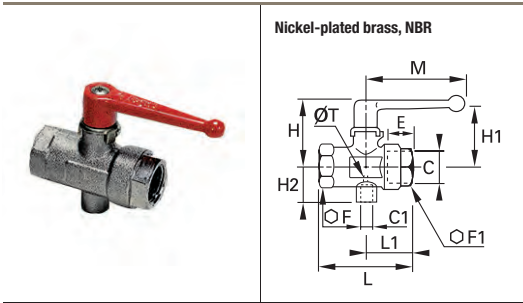

C	C1	DN		E	F	F1	H	H1	H2	L	L1	M	ØT	kg
G1/4	M5x0.8	7	0489 07 13	12	24	24	46	43	17	59	31	69	2	0.270
G3/8	M5x0.8	10	0489 10 17	12	24	24	46	43	17	59	31	69	2	0.243
G1/2	G1/8	13	0489 13 21	15	27	27	47	44	24	67	34	69	2	0.310
G3/4	G1/4	18	0489 18 27	16.5	32	38	63	54	33	80	39	108	2.5	0.670
G1	G1/4	23	0489 23 34	19	41	46	67	57	37	94	47	108	3	1.050

Maximum working pressure: 40 bar

0449 3/2 Panel-Mountable In-Line Ball Valve, Female BSPP and Metric Thread

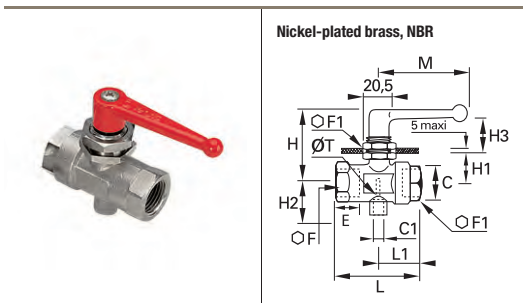

C	C1	DN		E	F	F1	H	H1	H2	H3	L	L1	M	ØT	kg
G1/4	M5x0.8	7	0449 07 13	12	24	27	50	20	17	21	59	31	69	2.5	0.313
G3/8	M5x0.8	10	0449 10 17	12	24	27	50	20	17	21	59	31	69	2.5	0.291
G1/2	G1/8	13	0449 13 21	15	27	27	52	23	24	21	67	34	69	4	0.352

Maximum working pressure: 20 bar

0469 3/2 In-Line Vented Ball Valve, Female BSPP Thread

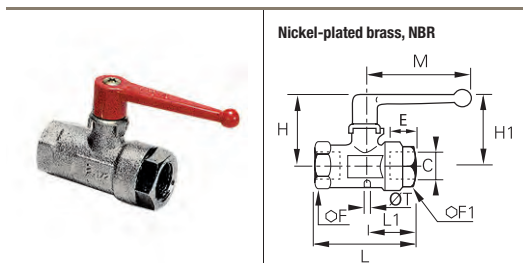

C	DN		E	F	F1	H	H1	L	L1	M	ØT	kg
G1/8	4	0469 04 10	8	14	14	35	29	44	25	48	1.5	0.092
G1/4	7	0469 07 13	12	24	24	46	43	59	31	70	2	0.268
G3/8	10	0469 10 17	12	24	24	46	43	59	31	70	2	0.246
G1/2	13	0469 13 21	15	27	27	47	44	67	34	70	2	0.294
G3/4	18	0469 18 27	16.5	32	38	63	54	80	39	108	2.5	0.668
G1	23	0469 23 34	19	41	46	67	57	94	47	108	3	1.026

Maximum working pressure: 40 bar

Operation of Vented Ball Valves

With vent connected to a tube = collection of purged media

With vent connected to a silencer = noiseless discharge to atmosphere

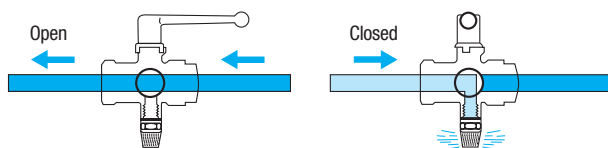
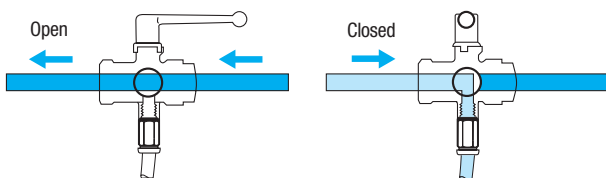



You will find our ranges of fittings, tubing and silencers in Chapters 1, 3 and 9.

Universal Series, Vented

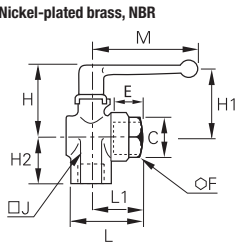

0462 3/2 Right-Angled Ball Valve with Vent, Female BSPP Thread



	Nickel-plated brass, NBR				C DN	E F H H1 H2 J L L1 M kg											
	G1/8	6					0462 06 10	8	19	38	31	20	22	37	27	48	0.192
	G1/4	6					0462 06 13	12	19	38	31	24	22	38	28	48	0.185
	G3/8	9					0462 09 17	12	24	45	43	27	25	46	31	69	0.261
	G1/2	12					0462 12 21	15	27	47	44	33	29	49	34	69	0.312
	G3/4	18					0462 18 27	16.5	38	59	51	40	39	60	39	108	0.698
G1	23	0462 23 34	19	46	63	55	47	48	72	47	108	1.066					
Maximum working pressure: 20 bar																	

0461 3/2 Right-Angled Ball Valve with Vent, Male/Female BSPP Thread

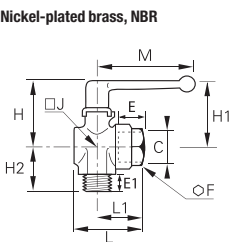

	Nickel-plated brass, NBR				C DN	E E1 F H H1 H2 J L L1 M kg												
	G1/8	6					0461 06 10	8	7	19	38	31	20	22	37	27	48	0.182
	G1/4	6					0461 06 13	12	9	19	38	31	24	22	38	28	48	0.186
	G3/8	9					0461 09 17	12	11	24	45	43	27	25	46	31	69	0.257
	G1/2	12					0461 12 21	15	12	27	47	44	33	29	49	34	69	0.304
	G3/4	18					0461 18 27	16.5	12	38	59	51	40	39	60	39	108	0.648
Maximum working pressure: 20 bar																		

Operation of Right-Angled Vented Ball Valves

Operation of Lockable Vented Ball Valves

With pin-hole vent = purge to atmosphere without silencer

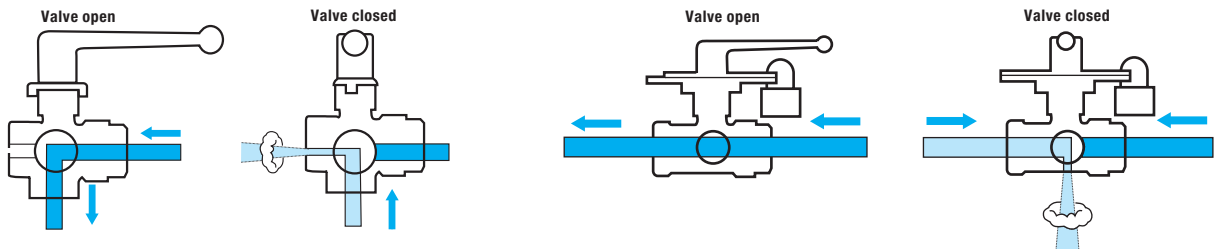

Removable lever: where the lever is obstructed in its movement, it can be refitted the opposite way.

Operation of 3/2 Lockable Valves

Drilled below and square in the horizontal plane, these valves provide a connection between: either port 1 and port 2, or port 2 and port 3.

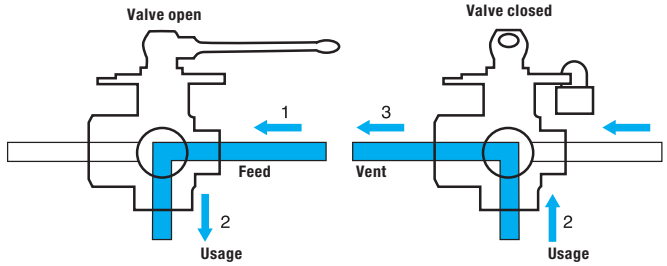



Removable lever: where the lever is obstructed in its movement, it can be refitted the opposite way.

Universal Series, Lockable

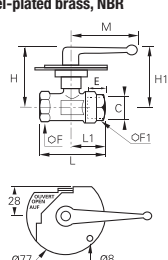

0432 2/2 In-Line Lockable Ball Valve, Female BSPP Thread



	<p>Nickel-plated brass, NBR</p> 	C	DN		E	F	F1	H	H1	L	L1	M	kg
		G1/8	4	0432 04 10	8	19	19	59	54	51	27	69	0.415
		G1/4	7	0432 07 13	12	19	19	59	54	59	28	69	0.396
		G3/8	10	0432 10 17	12	24	24	60	55	59	31	69	0.460
		G1/2	13	0432 13 21	15	27	27	62	57	67	34	69	0.522
		G3/4	20	0432 20 27	16.5	32	38	66	56	80	39	108	0.800
		G1	23	0432 23 34	19	41	46	70	59	94	47	108	1.186
<p>Maximum working pressure: 40 bar Handle is not removable. Fixed and mobile plates: zinc-plated steel.</p>													

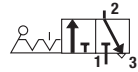

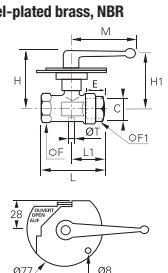
0439 3/2 In-line Vented Lockable Ball Valve, Female BSPP Thread



	<p>Nickel-plated brass, NBR</p> 	C	DN		E	F	F1	H	H1	L	L1	M	ØT	kg
		G1/8	4	0439 04 10	8	19	19	59	54	51	27	69	2	0.410
		G1/4	7	0439 07 13	12	19	24	60	55	59	31	69	2	0.480
		G3/8	10	0439 10 17	12	24	24	60	55	59	31	69	2	0.460
		G1/2	13	0439 13 21	15	27	27	62	57	67	34	69	2	0.514
		G3/4	18	0439 18 27	16.5	32	38	66	56	80	39	108	2.5	0.810
		G1	23	0439 23 34	19	41	46	70	59	94	47	108	3	1.185
<p>Maximum working pressure: 40 bar Handle is not removable. Fixed and mobile plates: zinc-plated steel.</p>														

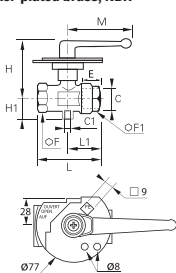

0436 3/2 In-Line Lockable Ball Valve with Threaded Exhaust Port, Female BSPP and Metric Thread



	<p>Nickel-plated brass, NBR</p> 	C	C1	DN		E	F	F1	H	H1	L	L1	M	kg
		G3/8	M5x0.8	10	0436 10 17	12	24	24	60	17	60	32	69	0.475
		G1/2	G1/8	13	0436 13 21	15	27	27	60	24.5	67.5	34.5	69	0.500
		G3/4	G1/4	18	0436 18 27	16.5	32	38	69.5	33	80	39.5	108	0.850
		G1	G1/4	23	0436 23 34	19	32	38	69.5	33	80	39.5	108	1.215
<p>Maximum working pressure: 40 bar Handle is not removable. Fixed and mobile plates: zinc-plated steel.</p>														

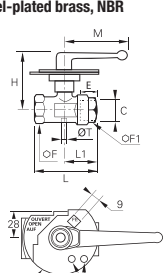

0437 3/2 In-line Vented 3-Point Lockable Ball Valve, Female BSPP Thread



	<p>Nickel-plated brass, NBR</p> 	C	DN		E	F	F1	H	L	L1	M	ØT	kg
		G1/4	7	0437 07 13	12	24	24	60	59	32	69.5	2	0.476
		G3/8	10	0437 10 17	12	24	24	60	60	32	69.5	2	0.456
		G1/2	13	0437 13 21	15	27	27	60	67.5	34.5	69.5	2	0.510
		G3/4	18	0437 18 27	16.5	32	38	69.5	80	39.5	108.5	2.5	0.820
		G1	23	0437 23 34	19	41	46	73	94.5	47.5	108.5	3	1.192
<p>Maximum working pressure: 40 bar Handle is not removable. Fixed and mobile plates: zinc-plated steel.</p>													

0438 3/2 Right-Angled 3-Point Lockable Ball Valve, Female BSPP Thread

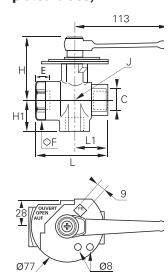

	<p>Nickel-plated brass, NBR</p> 	C	DN		E	F	H	H1	J	L	L1	kg
		G3/8	9	0438 09 17	12	38	76	34	39	73	35	0.970
		G1/2	12	0438 12 21	15	38	76	37	39	78	38	0.947
		G3/4	18	0438 18 27	16.5	38	76	40	39	80	40	0.905
		G1	23	0438 23 34	19	46	80	47	48	94	47	1.295
<p>Maximum working pressure: 20 bar Fixed plate: zinc-plated steel, mobile plate: steel, grey epoxy-coated. Removable handle: where the handle is obstructed in its movement, it can be refitted opposite the original position.</p>												

Ball Valves
Industrial Valves

Ball Valves, Universal Light Series

Using the Universal Series technology, the Parker Legris light series valves offer the advantages of **compactness**, **ease of operation** and **long-term reliability**.

Product Advantages

- Easy-to-Use**
 - Ease of operation due to the low friction design
 - The short levers may be repositioned and exchanged
 - Extremely compact
 - Wide range of configurations
- Maximum Efficiency**
 - Excellent performance under vacuum
 - Full flow
 - Chemical nickel-plated brass with high phosphorous content for outstanding corrosion resistance
 - Automatic seal wear compensation system
- Reliability**
 - Tried-and-tested technology
 - Forged brass provides mechanical strength and long service life
 - 100% leak-tested in production
 - Date coding to guarantee quality and traceability



- Applications**
- Vacuum
 - Transportation
 - Packaging
 - Textile
 - Pneumatics
 - Sawmills
 - Rubber & Plastics

Technical Characteristics

Compatible Fluids	Compressed air Other fluids: see compatibility chart at the end of this chapter
Working Pressure	Vacuum to 12 bar
Working Temperature	-20°C to +80°C

Tightening Torques	Threads	G1/8	G1/4	G3/8	G1/2	G3/4
	daN.m	0.10 to 0.20	0.10 to 0.20	0.15 to 0.25	0.20 to 0.35	0.50 to 0.70

Reliable performance is dependent upon the type of fluid conveyed, component materials and tubing being used.
Guaranteed for use with a vacuum of 755 mm Hg (99% vacuum).

Component Materials

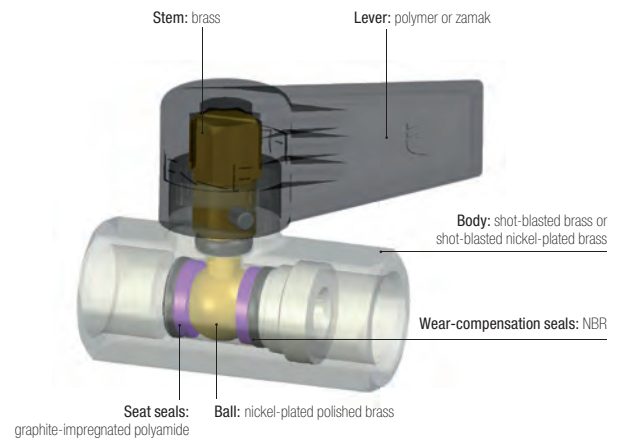

Silicone-free

Regulations

- DI: 97/23/EC (module PED A - diameters greater than 25 mm)
- DI: 2006/42/EC (Machinery Directive)
- DI: 2002/95/EC (RoHS)
- RG: 1907/2006 (REACH)

Universal Light Series

0492 2/2 In-Line Ball Valve, Female BSPP Thread

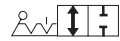

	Nickel-plated brass, NBR 	C	E	F	H	L	L1	M	kg
		G1/4 4 0492 04 13	9	17	34	39.5	17	35	0.073
		G3/8 7 0492 07 17	11	22	38	45	20	43	0.128
		G1/2 10 0492 10 21	12	24	44	54	25	50	0.162
		G3/4 13 0492 13 27	14	30	46	62	28	50	0.240
Technical polymer handle									

0492..64 2/2 In-Line Ball Valve, Short Handle, Female BSPP Thread



	Nickel-plated brass, NBR 	C	E	F	H	L	L1	M	kg
		G1/4 4 0492 04 13 64	9	17	36	39.5	17	25	0.090
		Short handle in zamak							

0491 2/2 In-Line Ball Valve, Male/Female BSPP Thread

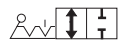

	Nickel-plated brass, NBR 	C	E	E1	F	H	L	L1	M	kg
		G1/4 4 0491 04 13	9	7	17	34	39.5	17	35	0.070
		G3/8 7 0491 07 17	11	8	22	38	45	20	43	0.124
		G1/2 10 0491 10 21	12	10	24	44	53	24	50	0.160
		G3/4 13 0491 13 27	14	12	30	46	59	25	50	0.238
Technical polymer handle										

0491..64 2/2 In-Line Ball Valve, Short Handle, Male/Female BSPP Thread



	Nickel-plated brass, NBR 	C	E	E1	F	H	L	L1	M	kg
		G1/4 4 0491 04 13 64	9	7	17	36	39.5	17	25	0.092
		Short handle in zamak								

0490 2/2 In-Line Ball Valve, Male BSPP Thread





	Nickel-plated brass, NBR 	C	E	F	H	L	L1	M	kg
		G1/4 4 0490 04 13	7	17	34	39	17	35	0.070
		G3/8 7 0490 07 17	8	22	38	44	20	43	0.109
		G1/2 10 0490 10 21	10	24	44	53	24	50	0.160
		G3/4 13 0490 13 27	12	30	46	59	25	50	0.233
Technical polymer handle									

Universal Light Series

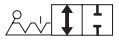

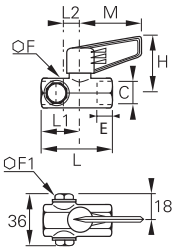
0494 2/2 In-Line Ball Valve, 2 Vent Plugs, Female BSPP Thread



	Nickel-plated brass, NBR 	C  	E	F	F1	H	L	L1	L2	M	kg
		G3/8 7 0494 07 17	11	22	16	38	60	20	15	43	0.178
Technical polymer handle											

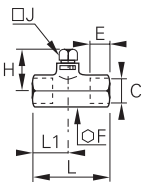

0497 2/2 Ball Valve, Square Stem, Female BSPP Thread



	Brass, NBR 	C  	E	F	H	J	L	L1	kg
		G1/4 4 0497 04 13	9	17	25	7	39	17	0.066
		G3/8 7 0497 07 17	11	22	26	7	45	20	0.122
		G1/2 10 0497 10 21	12	24	29	10	54	25	0.148
		G3/4 13 0497 13 27	14	30	30	10	62	28	0.230

0496 2/2 Ball Valve, Square Stem, Male/Female BSPP Thread

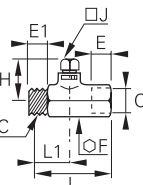

	Brass, NBR 	C  	E	E1	F	H	J	L	L1	kg
		G1/4 4 0496 04 13	7	9	17	25	7	39	17	0.065
		G3/8 7 0496 07 17	8	11	22	26	7	45	20	0.118
		G1/2 10 0496 10 21	10	12	24	29	10	53	24	0.150
		G3/4 13 0496 13 27	12	14	30	30	10	59	28	0.222



Ball Valves

Industrial Valves

Ball Valves, DVGW Series

The combination of long threads, a reinforced sealing system and **DVGW** certification makes this valve perfect for the **transmission of gas and water**.

Product Advantages

Reliability & Sealing Stem prevented from being ejected in the event of overpressure
Two stem seals to prevent leakage
Date coding to guarantee quality and traceability

Optimum Performance Full flow minimises pressure drop
Nickel-plated brass provides improved corrosion resistance and increased chemical compatibility
Can be operated at very low temperatures

Long Threads Excellent fitting compatibility:

- dimensions compliant with DIN 3357
- BSPP threads compliant with DIN 2999/ISO 228



Robotics
Pneumatics
Water & Gas Handling
Machine Tools
Textile
Wood Industry

Applications

Technical Characteristics

Compatible Fluids	Compressed air, water, gas
Working Pressure	1/4" to 2": 0 to 40 bar
Working Temperature	-40°C to +170°C

Reliable performance is dependent upon the type of fluid conveyed.

Component Materials

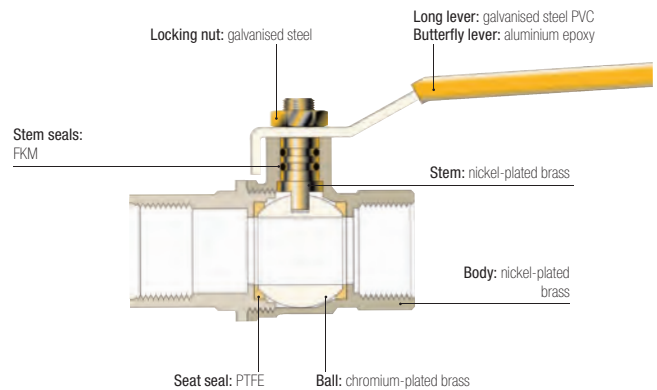

Silicone-free

Working Pressure and Temperature

Pressure - Temperature

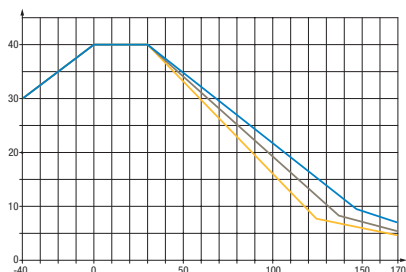

Pressure Drop

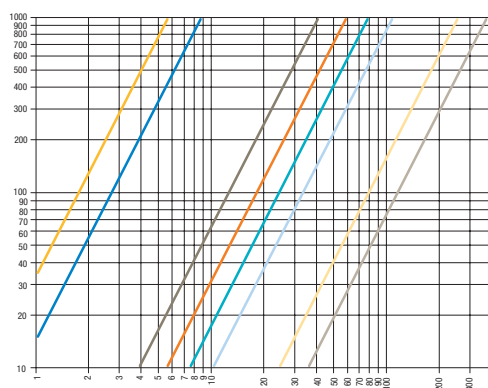

Regulations

Industrial
DI: 97/23/EC
(PED B+D module EC 1115)
Water
DVGW: W 570-1
DIN EN 13228
BGA KTW
DVGW: W270
Gas
DIN EN 33

DVGW Series

BVG4-L 2/2 In-Line Ball Valve, Female BSPP Thread

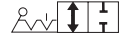

Nickel-plated brass, PTFE

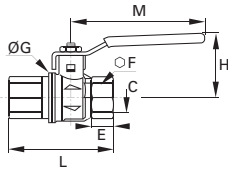

C	DN		E	F	ØG	H	L	M	kg
G1/4	8	BVG4-1/4L	12	20	25	38	50	82	0.150
G3/8	10	BVG4-3/8L	12	20	25	38	60	82	0.150
G1/2	15	BVG4-1/2L	15.5	25	32.5	43	75	100	0.255
G3/4	20	BVG4-3/4L	17	32	39	50	80	120	0.390
G1	25	BVG4-1L	21	41	47.5	54	90	120	0.590
G1¼	32	BVG4-1,1/4L	23	50	59	73	110	158	0.980
G1½	40	BVG4-1,1/2L	23	55	71.5	79	120	158	1.205
G2	50	BVG4-2L	26.5	70	86	86	140	158	1.960

BVGT4-L 2/2 In-Line Ball Valve, Female BSPP Thread



Nickel-plated brass, PTFE

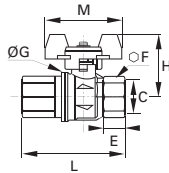

C	DN		E	F	ØG	H	L	M	kg
G1/4	8	BVGT4-1/4L	12	20	25	39	50	50	0.150
G3/8	10	BVGT4-3/8L	12	20	25	39	60	50	0.150
G1/2	15	BVGT4-1/2L	15.5	25	32.5	43	75	50	0.230
G3/4	20	BVGT4-3/4L	17	32	39	47	80	60	0.350
G1	25	BVGT4-1L	21	41	47.5	51	90	60	0.550

Compact lever

Ball Valves, Standard Series

This range of valves with **fluoropolymer seals**, available in compact, standard and lockable series, covers many **industrial applications** for which the fluids conveyed and working temperatures require this seal material.

Product Advantages

Optimised Installation

- Full fluid flow
- Long or butterfly lever
- Corrosion resistance
- A lockable version for operational safety
- Good value/performance ratio

Wide Compatibility

- Numerous compatible fluids
- Can be used for low and medium pressure applications
- Surface treatment for corrosion protection



Applications

- Machine Tool
- Agricultural Machinery
- Textile
- Pneumatics
- Plumbing
- Air Conditioning
- Heating

Technical Characteristics

Model	Standard and Lockable Series	Compact Series
Compatible Fluids	Compressed air, gas, water, water vapour, oil and all fluids compatible with the component materials	
Working Pressure	0 to 30 bar	0 to 35 bar
Working Temperature	-20°C to +130°C	-10°C to +90°C

Reliable performance is dependent upon the type of fluid conveyed.

Component Materials

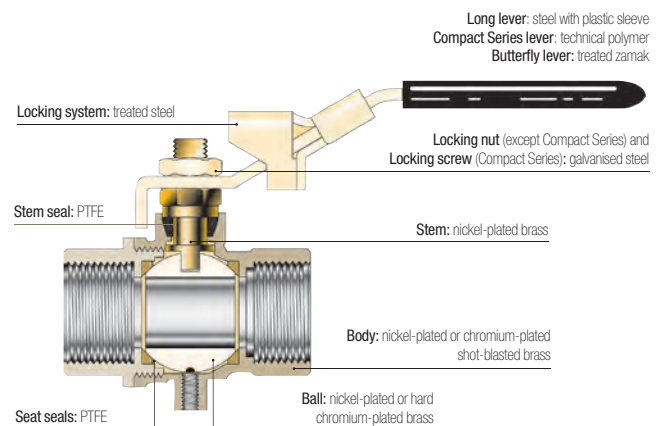

Silicone-free



Regulations

Industrial
DI: 97/23/EC (module PED A - EC diameters greater than 25 mm)
DI: Machinery Directive 2006/42/EC
DI: 2002/95/EC (RoHS)
RG: 1907/2006 (REACH)
DI: 89/392/EC

Standard Series

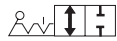
4902 2/2 Standard In-Line Ball Valve, Female BSPP Thread

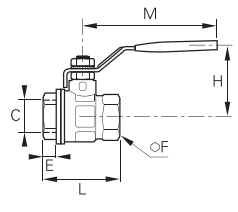



	Nickel-plated brass, PTFE 	C	DN		PN	E	F	H	L	M	kg
		G1/4	10	4902 10 13	30	11	20	43	51.5	98	0.154
		G3/8	10	4902 10 17	30	11.4	20	43	51.5	98	0.138
		G1/2	15	4902 15 21	30	13.5	25	47	55	98	0.202
		G3/4	20	4902 20 27	30	12.5	31	58	69.5	122	0.322
		G1	25	4902 25 34	30	15	38	60	69.5	122	0.468
		G1¼	32	4902 32 42*	25	17	48	77	81.5	153	0.794
		G1½	40	4902 40 49*	25	18	54	83	95	153	1.082
		G2	50	4902 50 48*	25	22	66	95	113	162	1.787
		G2½	65	4902 65 47*	30	22	85	132	136	255	4.500
G3	80	4902 80 46*	30	25	99	140	157	255	5.840		
G4	100	4902 01 45*	30	29	125	154	191	255	9.040		

*Models with CE marking
 Model from 2½": double stem seal in FPM
 Working temperature: -40°C to +170°C

BVGT4-C 2/2 Standard In-Line Ball Valve, Female BSPP Thread

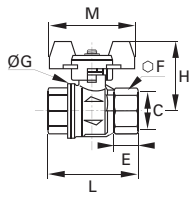



	Sand-blasted nickel-plated brass, PTFE 	C	DN		E	F	G	H	L	M	kg
		G1/4	8	BVGT4-1/4C	9	20	25	40	39	50	0.130
		G3/8	10	BVGT4-3/8C	9	20	25	40	39	50	0.120
		G1/2	15	BVGT4-1/2C	11	25	32.5	44	50	50	0.180
		G3/4	20	BVGT4-3/4C	12	31	39	49	54	50	0.265
		G1	25	BVGT4-1C	14	38	47.5	53	67	50	0.390

Compact lever

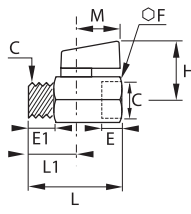

4991 2/2 Standard Compact In-Line Ball Valve, Male/Female BSPP Thread



	Chromium-plated brass, PTFE 	C	DN		E	E1	F	H	L	L1	M	kg
		G1/8	6	4991 00 10	10	10	21	30	41.5	10	24	0.091
		G1/4	8	4991 00 13	11	11	21	30	41.5	11	24	0.087
		G3/8	8	4991 00 17	11	11	21	30	41.5	10.5	24	0.087
		G1/2	10	4991 00 21	13	13	25	32	49	12.5	24	0.134

4992 2/2 Standard Compact In-Line Ball Valve, Female BSPP Thread

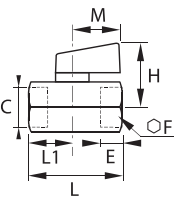

	Chromium-plated brass, PTFE 	C	DN		E	F	H	L	L1	M	kg
		G1/8	6	4992 00 10	10	21	30	41.5	10	24	0.110
		G1/4	8	4992 00 13	11	21	30	41.5	11	24	0.106
		G3/8	8	4992 00 17	11	21	30	41.5	10.5	24	0.094
		G1/2	10	4992 00 21	13	25	32	49	12.5	24	0.142

Standard Series

BVG4-LOCK

2/2 In-Line Lockable Ball Valve, Female BSPP Thread



Sand-blasted nickel-plated brass, PTFE

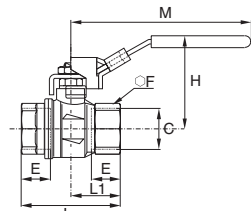

C	DN		E	F	H	L	L1	M	kg
G1/4	8	BVG4-1/4LOCK	12	20	47.5	45	22.5	96	0.154
G3/8	10	BVG4-3/8LOCK	12	20	47.5	45	22.5	96	0.171
G1/2	15	BVG4-1/2LOCK	15.5	25	52	59	29.5	96	0.238
G3/4	20	BVG4-3/4LOCK	17	31	59.5	64	32	117	0.370
G1	25	BVG4-1LOCK	21	40	63.5	81	40.5	117	0.580

BVG4P-LOCK

2/2 In-Line Lockable Vented Ball Valve, Female BSPP Thread



Sand-blasted nickel-plated brass, PTFE

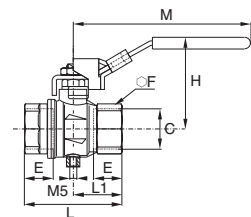

C	DN		E	F	H	L	L1	M	kg
G1/4	8	BVG4P-1/4LOCK	12	20	47.5	45	22.5	96	0.155
G3/8	10	BVG4P-3/8LOCK	12	20	47.5	45	22.5	96	0.172
G1/2	15	BVG4P-1/2LOCK	15.5	25	52	59	29.5	96	0.239
G3/4	20	BVG4P-3/4LOCK	17	31	59.5	64	32	117	0.371
G1	25	BVG4P-1LOCK	21	40	63.5	81	40.5	117	0.581

Ball Valves: Usage Chart

The chart below shows the compatibility between valves and fluids along with their pressure and temperature characteristics.

Certain models have a maximum working pressure which differs from that given in this table. In this case, the pressure is shown in the heading for the model number in question.

N.B.: Above 32 mm or 1¼" diameters, divide the maximum pressure by 2.

If the fluid you are using is not shown in this chart, please contact us.

Chemical Description	Maximum Pressure (bar)	Temperature °C		Universal and Light Series	Standard Series	DVGW series	Customised Series							
		Min.	Max.				20	22	26	27	30	32		
"Aromatic" hydrocarbons	20	-20	+60					●						
Acetone and other ketones	20	-20	+60											●
Acetophenone	20	-20	+60											●
Acetylene - Acetone	20	-20	+60											●
Acetylene (gas)	20	-20	+60	●	●	●								
Alcohol (100%)	20	-20	Boiling											●
Aluminium (liquid suspension, thick)	40	-20	+90	●	●	●								
Amyl alcohol	20	-20	Boiling											●
Animal fats, greases	20	+5	+200		●	●			●					
Antifreeze or glycol (diluted)	40	-20	+40	●	●	●								
Argon (gas) Ar	20	-20	+60	●	●	●								
Barium - Hydroxide	20	-20	+40											●
Benzaldehyde	20	-20	+60											●
Benzene	20	-20	+60					●						
Benzyl alcohol	20	-20	Boiling					●						
Borax (pastes or solutions)	20	-20	+60											●
Brake fluids (automobile)	20	-20	+90											●
Bromochlorotrifluorethane	20	-20	+60		●	●			●					
Butadiene (hydrocarbon)	20	-20	+60										●	
Butane	20	-20	+60	●	●	●								
Butanol	20	-20	Boiling					●						
Butyl alcohol	20	-20	Boiling					●						
Butylene (hydrocarbon)	20	-20	+60					●						
Carbon dioxide gas CO ₂	40	-20	+60	●	●									
Castor oil	40	-20	+90	●	●									
Compressed air	20	-25	+180					●						
Creosotes	20	-20	+60										●	
Cresols	20	-20	+60										●	
Crude oil	20	-20	+40					●						
Cutting oil	40	-20	+90	●	●									
Decalin (hydrocarbon, solvent)	20	-20	+60										●	
Detergents (solutions)	20	-20	+100											●
Diacetone alcohol	20	-20	Boiling											●
Diesel oils	40	-20	+90	●	●									
Di-Esters	20	-20	+90					●						
Di-Isobutylene	20	-20	+60										●	
Di-Pentane	20	-20	+60					●						

The above recommendations are given in good faith. However, since each application is different, it is advisable to undertake tests in actual working conditions.

Ball Valves: Usage Chart

Chemical Description	Max. Pressure (bar)	Temperature °C		Universal and Light Series	Standard Series	DVGW Series	Customised Series						
		Min.	Max.				20	22	26	27	30	32	
Di-Pentene (solvents, varnish)	20	-20	+60					●					
Di-Phenyl-Oxide (thin detergents)	20	-20	+60								●		
Distilled water	40		+90	●	●	●							
Edible fats	20	+5	+200		●					●			
Edible oils	20	+5	+200		●					●			
Erytrene (see Butadiene)	20	-20	+60								●		
Ethane (gas) CH ₂ CH ₃	20	-20	+60	●	●								
Ethane (hydrocarbon gas)	20	-20	+60								●		
Ethyl alcohol	20	-20	+60										●
Ethylene glycol (antifreeze) - see Glycols	20	-20	+120										●
Fatty alcohols	20	-20	Boiling					●					
Fuel oils	40	-20	+40	●	●	●							
Fuels-Diesels	40	-20	+40	●	●								
Gaseous oxygen (ambient air)	20	-20	+40									●	
Glycerine	20	-20	+40	●	●								
Glycol (for antifreeze, lubricants)	40	-20	+40	●	●								
Graphite in suspension in water, oils and greases	40	-20	+90	●	●								
Greases (from petroleum)	40	-20	+90	●	●								
Helium (gas)	20	-20	+60									●	
Heptanal	20	-20	+50	●	●								
Hexane (solvent)	20	-20	+60									●	
Hydraulic oils (petroleum-based)	40	-20	+90	●	●								
Hydrogen (gas)	20	-20	+60									●	
Inks	20	-20	+60								●		
Insecticides	20	0	+40	●	●	●							
Iso-Butane (aliphatic hydrocarbon)	20	-20	+60								●		
Iso-Octane	20	-20	+60								●		
Isopropyl alcohol	20	-20	Boiling										●
Krypton (gas) Kr	20	-20	+60	●	●	●							
Light water	40		+80	●	●	●							
Lighting gas	20	-20	+40			●							
Methane (gas) CH ₄	20	-20	+60	●	●	●							
Methanol	20	-20	Boiling										●
Methyl alcohol	20	-20	Boiling										●
Methylated spirit	40	-20	+40	●	●	●							
Mineral oils	40	-20	+90	●	●								
Natural gas	20	-20	+40			●							
Natural waxes (vegetable, beeswax, carnauba, Chinese, lignite)	40	-20	+90								●		
Neatsfoot oil	40	-20	+90	●	●	●							
Neon (Gas) Ne	20	-20	+60	●	●	●							
Nitrogen (gas) N ²	40	-20	+90	●	●	●							
Oil (petroleum-based) and water emulsions	40	-20	+90	●	●	●							

The above recommendations are given in good faith. However, since each application is different, it is advisable to undertake tests in actual working conditions.

Ball Valves: Usage Chart

Chemical Description	Max. Pressure (bar)	Temperature °C		Universal and Light Series	Standard Series	DVGW Series	Customised Series						
		Min.	Max.				20	22	26	27	30	32	
Oils "synthetic"	20	-20	+100										●
Ordinary petrol	20	-20	+40	●	●								
Oxygenated water	40	-20	+30				●						
Paints and relevant solvents	20	-20	+60		●	●			●				
Paraffin oil	40	-20	+90	●	●	●							
Paraffins	20	-20	+60	●	●	●							
Pentane (liquid hydrocarbon)	20	-20	+60	●	●	●							
Pentanol 1 and 2	20	-20	Boiling										●
Petrol "super"	20	-20	+40				●						
Petroleum mineral oils	20	-20	+160					●					
Phenol (aqueous or alcoholic)	20	-20	+60		●	●			●				
Propane	20	-20	+60	●	●	●							
Propanol 1 and 2	20	-20	Boiling										●
Propanone 2	20	-20	+60										●
Propene or Propylene	20	-20	+60					●					
Propyl alcohol	20	-20	Boiling										●
Propylene or Propene	20	-20	+60					●					
Rapeseed oil	40	-20	+90	●	●								
Saponifying liquids	20	-20	+30	●	●	●							
Seawater	40		+80	●	●	●							
Seawater (high temperature)	20		+150			●				●			
Soaps	20	-20	+100										●
Soaps (liquid or paste)	40	-20	+40	●	●	●							
Sodium carbonate (with water)	20	0	+40	●	●	●							
Starch (gels or pastes)	40	+10	+40	●	●	●							
Steam	20	-20	+150										●
Toluene (terpenic hydrocarbon)	20	-20	+60		●	●			●				
Trichlorethylene	20	-20	+65					●					
Turpentine	20	-20	+50	●	●	●							
Varnish and paints	20	-20	+60		●	●			●				
Vaseline	40	-20	+60	●	●	●							
Vaseline oil	40	-20	+90	●	●	●							
Water (carbonated)	40		+90	●	●	●							
Water (high temperature)	20		+150			●							●
Xenon (gas) Xe	20	-20	+60	●	●	●							
Xylene	20	-20	+60					●					

Ball Valves
Industrial Valves

The above recommendations are given in good faith. However, since each application is different, it is advisable to undertake tests in actual working conditions.

Ball Valves, Stainless Steel Series

Stainless steel series ball valves can withstand **corrosive fluids** and **environments**.

With full flow, high pressure and temperature capabilities, these valves are suitable for many applications.

Product Advantages

Reliability

- Full flow
- Excellent chemical compatibility
- High resistance to pressure/temperature
- Light series version: 100% leak-tested in production, date coding to guarantee quality and traceability

Versatility

Three in-line versions:

- One-piece: cannot be disassembled
- 3-piece: easily disassembled for maintenance and cleaning
- Light Series: for maximum compactness

Fixing plate: 4812 and 4832

- Through-bulkhead fitting
- Pneumatic or electronic actuation (ISO 5211 standard)



Applications

- Food Process
- Aviation
- Chemical
- Semi-Conductors
- Medical
- Petrochemical
- Laboratories
- Pharmaceutical

Technical Characteristics

Compatible Fluids	Type 4810, 4812 and 4832	Type 0465
	All fluids	All fluids
Working Pressure	0 to 65 bar	Vacuum to 20 bar
Working Temperature	-20°C to +150°C	-20°C to +120°C

Component Materials

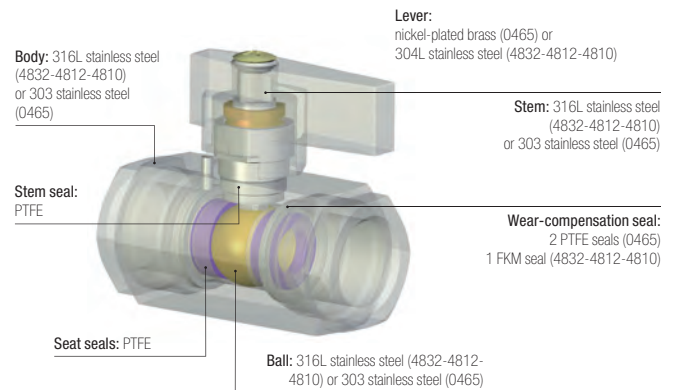

Reliable performance is dependent upon the type of fluid conveyed, component materials and tubing being used. Guaranteed for use with a vacuum of 755 mm Hg (99% vacuum).

Pressure and Temperature Resistance

Version 4810, 4812 and 4832

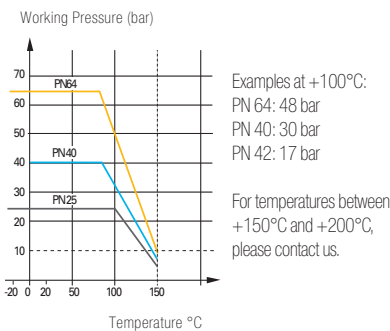

Version 0465

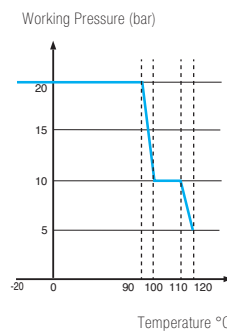

Regulations

Industrial

- DI: 97/23/EC (module PED A - EC diameters greater than 25 mm)
- DI: Machinery Directive 2006/42/EC
- DI: 2002/95/EC (RoHS)
- RG: 1907/2006 (REACH)
- DI: 89/392/EC

Stainless Steel Series

4832 2/2 In-Line 3-Piece Ball Valve with Fixing Plate, Female BSPP Thread

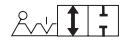

Stainless steel 316L, PTFE		C	DN		E	F	G	H	K	L	M	ØT	kg
		G1/4	10	4832 10 13	18	22	36	50	36	57	110.5	5.5	0.272
		G3/8	10	4832 10 17	18	22	36	50	36	57	110.5	5.5	0.400
		G1/2	15	4832 15 21	20.5	27	36	64	36	65	131.5	6	0.442
		G3/4	20	4832 20 27	22.5	32	42	68	42	76	131.5	5.5	0.568
		G1	25	4832 25 34	27	41	42	78.5	42	92	174.5	6	1.035
		G1¼	32	4832 32 42*	30	50	42	83.5	42	106.5	174.5	5.5	1.530
		G1½	40	4832 40 49*	31	55	50	100	50	116	250.5	6.5	2.146
		G2	50	4832 50 48*	36	70	50	107	50	136	250.5	6.5	3.140

*Models with CE marking

4812 2/2 In-Line Ball Valve with Fixing Plate, Female BSPP Thread



Stainless steel 316L, PTFE		C	DN		E	G	H	L	M	ØT	kg
		G1/4	10	4812 10 13	10	36	50	55	110	5.5	0.263
		G3/8	10	4812 10 17	11	36	50	55	110	5.5	0.254
		G1/2	15	4812 15 21	15	36	53	66	110	5.5	0.336
		G3/4	20	4812 20 27	16	42	67	79	130	5.5	0.574
		G1	25	4812 25 34	19	42	79	93	175	5.5	1.000
		G1¼	32	4812 32 42*	21	42	83	100	175	5.5	1.337
		G1½	40	4812 40 49*	21	50	100	110	250	5.5	2.214
		G2	50	4812 50 48*	26	70	107	131	250	8.5	3.262

*Models with CE marking

4810 2/2 In-Line Ball Valve, Female BSPP Thread



Stainless steel 316L, PTFE		C	DN		E	G	H	L	M	kg
		G1/4	8	4810 08 13	10	30	44.5	53.5	110.5	0.205
		G3/8	10	4810 10 17	10	30	44.5	53.5	110.5	0.194
		G1/2	15	4810 15 21	13	32.5	47	60	110.5	0.245
		G3/4	20	4810 20 27	14	40	54.5	70	131.5	0.420
		G1	25	4810 25 34	17	49	58.5	79	131.5	0.648

Threads conform to ISO 228-1

0465 2/2 In-Line Light Series Ball Valve, Female BSPP Thread

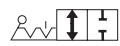

Stainless steel 303, PTFE		C	DN		E	F	F1	H	L	kg
		G1/4	4	0465 04 13	13	19	24	36	50	0.226
		G3/8	7	0465 07 17	13	24	27	39	55	0.278
		G1/2	10	0465 10 21	16	27	30	40	62	0.322

Silicone-free

Ball Valves
Industrial Valves

Ball Valves, High Pressure Series

These valves are suitable for **applications** with pressures **up to 300 bar**. High performance materials and quality manufacturing allow for a wide range of operating pressures and temperatures.

Product Advantages

High Pressure & Safety

- Good sealing at low and high pressure
- Robust design with secure, non-removable inlet and outlet ports
- Forged brass providing excellent long-term strength under severe conditions of use
- 100% leak-tested in production
- Date coding to guarantee quality and traceability

Easy-to-Use

- Fixing screws for through-bulkhead mounting
- The lever may be repositioned or replaced with a handwheel
- Low operating torque



- Applications**
- Automotive Process
 - Foundry
 - Forming
 - Machine Tools
 - Textile
 - Spectacle-Making Industry
 - Turbines
 - Deep-Sea Diving

Technical Characteristics

Compatible Fluids	Compressed air
Working Pressure	Vacuum to 300 bar
Working Temperature	-15°C to +80°C

Reliable performance is dependent upon the type of fluid conveyed, component materials and tubing being used. Guaranteed for use with a vacuum of 755 mm Hg (99% vacuum).

Component Materials

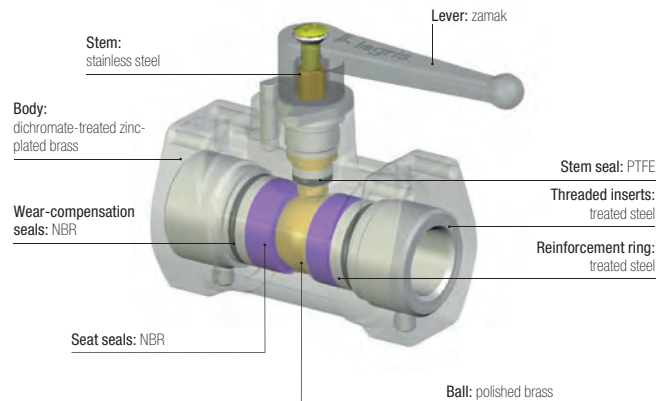

Silicone-free

Regulations

- DI: 97/23/EC (module PED A - diameters greater than 25 mm)
- DI: 2006/42/EC (Machinery Directive)
- DI: 2002/95/EC (RoHS)
- RG: 1907/2006 (REACH)

Installation Options

Bulkhead Mounting

Through bulkhead with screws

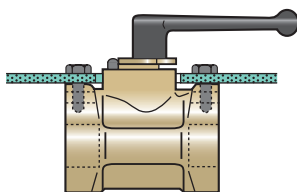

Surface Mounting

With brackets and screws

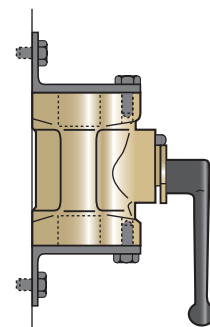

High Pressure Series

4402

2/2 In-Line High Pressure Ball Valve, Female BSPP Thread



	Treated brass, NBR														
	C	DN		E	H1	H2	H3	J	K	L	L1	N	N1	kg	
	G1/4	7	4402 07 13	12	50	13	15	30	30	58	25	15	20	0.402	
	G3/8	10	4402 10 17	12	54	23	19	36	39	72	36	20	30	0.722	
	G1/2	13	4402 13 21	15	56	23	21	40	42	79	36	20	30	0.870	

Ball Valves, Mini Series

With their **push-in connections**, these polymer lightweight ball valves allow for a significant reduction in installation time while offering **full flow capability** and **compact dimensions**.

Product Advantages

Optimum Solution

- Full flow
- Marked with the pneumatic symbol for identification of its function
- Lightweight and compact
- Extremely compact, easy-to-operate lever
- Lever with screwdriver slot to facilitate operation
- Designed for polymer tubing with no tube preparation
- Can be mounted on a wall or adjacent using staples



Proven Technology

- LF 3000® push-in connection, excellent static and dynamic sealing
- High-strength polyamide
- Excellent long-term performance
- Automatic seal wear compensation for long-term reliability
- 100% leak-tested in production
- Date coding to guarantee quality and traceability

- Applications**
- Robotics
 - Vacuum
 - Semi-Conductors
 - Packaging
 - Textile
 - Pneumatics

Technical Characteristics

Compatible Fluids	Compressed air			
Working Pressure	Vacuum to 10 bar			
Working Temperature	-20°C to +80°C			

Tightening Torques	Threads	G1/8	G1/4	G3/8	G1/2
	daN.m	0.8	1.2	3	3.5

Reliable performance is dependent upon the type of fluid conveyed, component materials and tubing being used.
Guaranteed for use with a vacuum of 755 mm Hg (99 % vacuum).

Component Materials

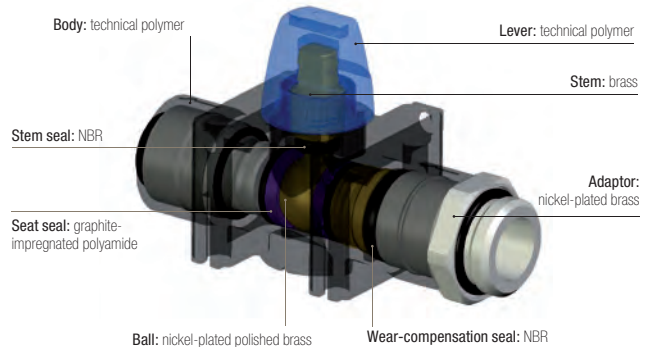

Silicone-free

Operation

Vented Valve, Open Position

3/2 model with vent

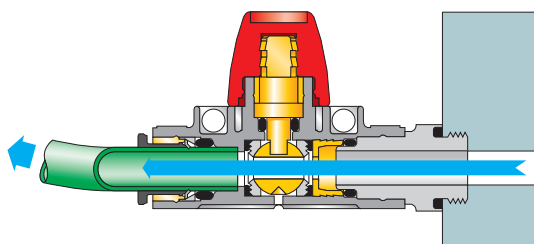

Vented Valve, Closed Position

Lever with screwdriver slot

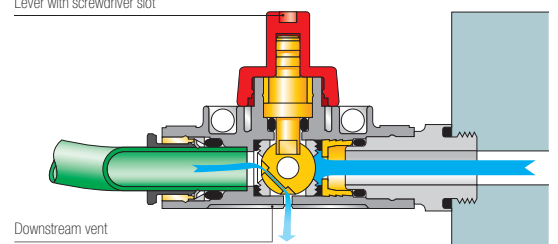

Mini Series

7910 2/2 In-Line Mini-Ball Valve

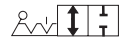

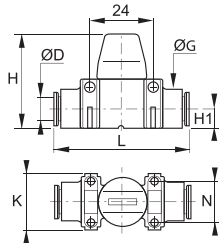
	<p>Technical polymer, NBR</p> 	ØD		G	H	H1	K	L	N	kg
		4	7910 04 00	15	37	7.5	22	51	16	0.039
		6	7910 06 00	15	37	7.5	22	52	16	0.034
		8	7910 08 00	15	37	7.5	22	52	16	0.025
		10	7910 10 00	20	43	11	30	66	22	0.060
		12	7910 12 00	20	43	11	30	66	22	0.040

7911 2/2 In-Line Mini-Ball Valve, Male BSPP Thread

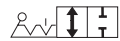

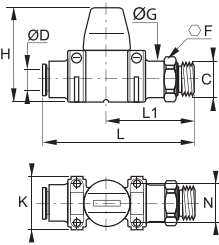
	<p>Technical polymer, nickel-plated brass, NBR</p> 	ØD	C		F	G	H	K	L	L1	N	kg
		6	G1/8	7911 06 10	13	14	37	22	62	37	16	0.045
		8	G1/4	7911 08 13	16	17.5	37	22	61	35	16	0.040
		10	G3/8	7911 10 17	20	22	43	30	74	41	22	0.075
		12	G1/2	7911 12 21	24	26	43	30	75	42	22	0.075

7913 3/2 In-Line Mini-Ball Valve with Vent



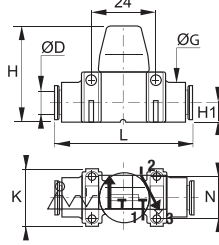

	<p>Technical polymer, NBR</p> 	ØD		G	H	H1	K	L	N	kg
		4	7913 04 00	15	37	7.5	22	51	16	0.040
		6	7913 06 00	15	37	7.5	22	52	16	0.035
		8	7913 08 00	15	37	7.5	22	52	16	0.025
		10	7913 10 00	20	43	11	30	66	22	0.060
		12	7913 12 00	20	43	11	30	66	22	0.045

7914 3/2 In-Line Mini-Ball Valve with Vent, Male BSPP Thread

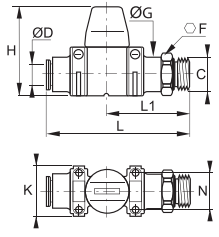

	<p>Technical polymer, nickel-plated brass, NBR</p> 	ØD	C		F	G	H	K	L	L1	N	kg
		6	G1/8	7914 06 10	13	14	37	22	62	37	16	0.045
		8	G1/4	7914 08 13	16	17.5	37	22	61	35	16	0.040
		10	G3/8	7914 10 17	20	22	43	30	74	41	22	0.058
		12	G1/2	7914 12 21	24	26	43	30	75	42	22	0.075

7000 Joining Clips

	<p>Technical polymer</p> 	ØD		kg
		4	7000 00 05	0.004
		6	7000 00 05	0.004
		8	7000 00 05	0.004
		10	7000 00 06	0.009
		12	7000 00 06	0.009

Ball Valves
Industrial Valves

LIQUIfit® Ball Valves

This range of valves offers an innovative solution in the treatment of **water and the handling of beverages** while protecting **health**. These **compact and reliable** valves offer perfect **sealing** and excellent **cleanliness**.

Product Advantages

Innovative Technology & Increased Reliability

- Full flow to limit turbulence
- Full-flow self-cleaning ball maintains the cleanliness of the circuit
- Tube retention with gripping ring prevents pumping effect
- Push-in connection and disconnection
- Sealing technology using patented EPDM seal

High Performance

- Inert technical polymer providing the best mechanical strength, thermal and chemical resistance
- Carstick® connection providing resistance to water hammer
- Other configurations available on request



- Applications**
- Beverage Dispensers
 - Inert Gases
 - Cooling
 - Food Process
 - Water Purification
 - Water Coolers

Technical Characteristics

Compatible Fluids	Water, drinks, beverages			
Working Pressure	0 to 10 bar at 20°C			
Working Temperature	-15°C to +100°C			
Tightening Torques	Threads	1/4" NPTF	3/8" NPTF	1/2" NPTF
	daN.m	1.5	3	3

Component Materials

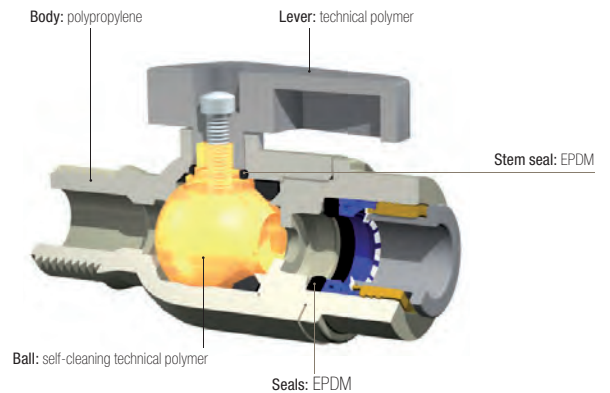

Silicone-free



Regulations

- FDA: 21 CFR
- NSF: 51 and lead < 0.25%
- WQA: Water Quality Association

LIQUIfit® Ball Valves

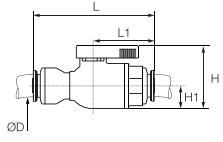

4020 2/2 In-Line Ball Valve

 **Inch**

	Polypropylene, glass fibre-reinforced, EPDM 	ØD		H	H1	L	L1	kg
		1/4	4020 56 00WP2	25	13	65	31	0.015
		3/8	4020 60 00WP2	36	13	68	30.5	0.028

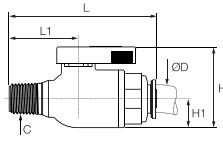

4021 2/2 In-Line Ball Valve, Male NPTF Thread

 **Inch**

	Polypropylene, glass fibre-reinforced, EPDM 	ØD	C		H	H1	L	L1	kg
		1/4	NPT1/4	4021 56 14WP2	36	13	61	31	0.029
		3/8	NPT3/8	4021 60 18WP2	36	13	64	33.5	0.028

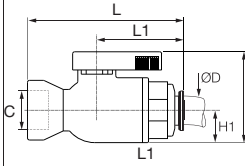

4023 2/2 In-Line Ball Valve, Female NPTF Thread

 **Inch**

	Polypropylene, glass fibre-reinforced, EPDM 	ØD	C		H	H1	L	L1	kg
		1/4	NPT1/4	4023 56 14WP2	36	13	58	31	0.000
		3/8	NPT3/8	4023 60 18WP2	36	13	64	33.5	0.000

4022 2/2 Right-Angled Ball Valve, Female NPTF Thread

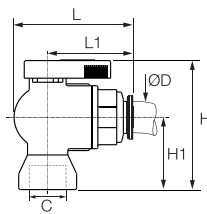
 **Inch**

	Polypropylene, glass fibre-reinforced, EPDM 	ØD	C		H	H1	L	L1	kg
		1/4	NPT1/4	4022 56 14WP2	52	29	44	31	0.016
		3/8	NPT3/8	4022 60 18WP2	52	29	47	33.5	0.027

3130 Tamper-Proof Safety Clip

Technical polymer

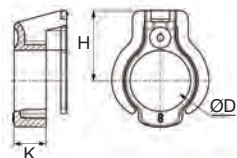

ØD							H	K	kg
1/4	3130 56 01	3130 56 02	3130 56 03	3130 56 04	3130 56 05	3130 56 10	8	3.2	0.001
3/8	3130 60 01	3130 60 02	3130 60 03	3130 60 04	3130 60 05	3130 60 10	10.8	4.2	0.001

Ball Valves
Industrial Valves

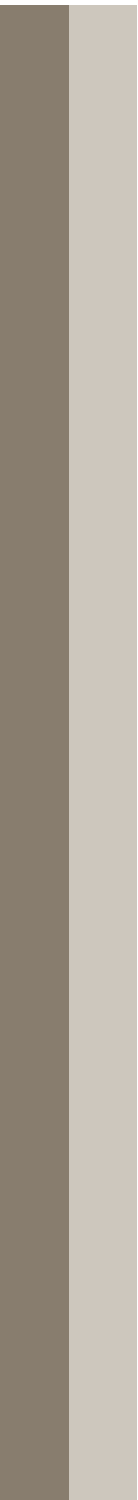

Needle and Butterfly Valves

Brass Needle Valve

In-Line

0502
Page 6-39

0501
Page 6-39

0510
Page 6-39



Right-Angled

0532
Page 6-39

0531
Page 6-39



Drain Valve

0562
BSPP/Metric
Page 6-40

0563
NPT
Page 6-40



Venting Pressure Gauge Valve

0627
BSPP
Page 6-40



Pressure Relief Valve

0630
BSPP
Page 6-40



Stainless Steel Needle Valve

In-Line

0591
Page 6-41



Butterfly Valve

In-Line

4602
Page 6-43



Needle Valves

Parker Legris compact needle valves can be installed in any system and are designed for applications requiring accurate **leak-free fluid control** and **excellent service life**.

Product Advantages

Robust and Easy-to-Use | Accurate flow control
 Forged brass for improved long-term mechanical strength
 Robust stem for good operational reliability
 Corrosion resistance

Wide Range | Two materials (nickel-plated brass and stainless steel) suitable for many applications
 Numerous valve and safety accessory configurations



Pneumatics
 Water Circuits
 Machine Tools
 Rubber Industry
 Packaging
 Textile

Applications

Technical Characteristics

	Brass	Stainless Steel			
Compatible Fluids	Compressed air, water, industrial fluids, etc. Other fluids: contact us	Many fluids			
Working Pressure	0 to 120 bar	0 to 400 bar			
Working Temperature	-20°C to +100°C (except model 0510)	-20°C to +180°C			
Tightening Torques	Threads	G1/8	G1/4	G3/8	G1/2
	daN.m	0.10 to 0.20	0.10 to 0.20	0.15 to 0.25	0.20 to 0.35

Reliable performance is dependent upon the type of fluid conveyed.

Component Materials

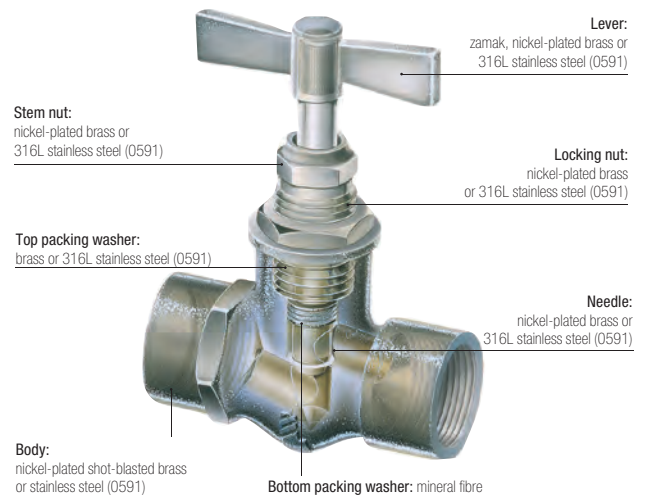

Silicone-free



Regulations

- DI: 97/23/EC (module PED A - diameters greater than 25 mm)
- DI: 2006/42/EC (Machinery Directive)
- DI: 2002/95/EC (RoHS)
- RG: 1907/2006 (REACH)

Brass Needle Valves

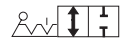

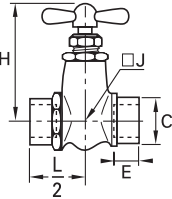
0502 In-Line Needle Valve, Female BSPP Thread



		Nickel-plated brass		C	DN		E	H	H_{max}	J	L/2	kg
		G1/8	4	0502 04 10	9	56	50	17	23	0.133		
		G1/4	4	0502 04 13	11	56	50	17	23	0.118		
		G3/8	6	0502 06 17	12	67	60	-	26	0.171		

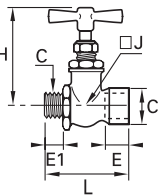

0501 In-Line Needle Valve, Male/Female BSPP Thread



		Nickel-plated brass		C	DN		E	E1	H	H_{max}	J	L	kg
		G1/8	4	0501 04 10	9	7	56	50	17	44	0.118		
		G1/4	4	0501 04 13	11	9.5	56	50	17	46	0.115		
		G3/8	6	0501 06 17	12	9.5	67	60	-	48	0.158		

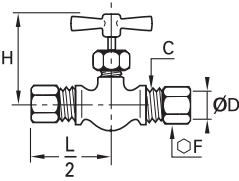

0510 In-Line Needle Valve with Compression Connections



		Nickel-plated brass		ØD	C	DN		F	H_{min}	H_{max}	L/2	kg
		6	M10x1	4	0510 04 06	13	42	46	29	0.083		
		8	M12x1	8	0510 05 08	14	42	46	30	0.083		
		10	M16x1.5	5	0510 05 10	19	42	46	31	0.111		
<p>The needle is sealed by an O-ring. Maximum operating pressure: Ø4: 100 bar, Ø5: 60 bar Working temperature: -15°C to +70°C Tightening torques: please refer to the Compression Fittings chapter of this catalogue.</p>												

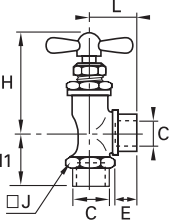

0532 Right-Angle Needle Valve, Female BSPP Thread



		Nickel-plated brass		C	DN		E	H_{min}	H_{max}	H1	J	L	kg
		G1/8	4	0532 04 10	9	46	52	19	17	19	0.093		
		G1/4	4	0532 04 13	11	46	52	21	17	21	0.087		
			6	0532 06 13	11	55	63	26	22	26	0.169		

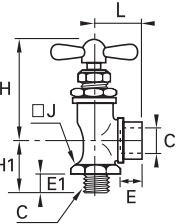

0531 Right-Angle Needle Valve, Male/Female BSPP Thread



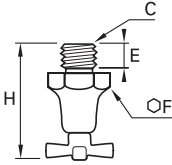

		Nickel-plated brass		C	DN		E	E1	H_{min}	H_{max}	H1	J	L	kg
		G1/8	4	0531 04 10	7	9	46	52	19	17	19	0.082		
		G1/4	4	0531 04 13	9.5	11	46	52	21	17	21	0.090		
		G1/4	6	0531 06 13	9.5	11	55	63	25	22	26	0.155		
		G3/8	6	0531 06 17	9.5	12	55	63	25	22	27	0.153		
		G1/2	10	0531 10 21	13	16	62	72	34	26	33	0.330		

Brass Needle Valves

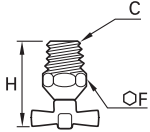

0562 Needle Drain Valve, Male BSPP and Metric Thread

	Brass		C			E	F	H	H	kg
			M10x1	5	0562 05 60	8	16	37.5	40	0.031
			G1/8	5	0562 05 10	8	16	36	40	0.032
			G1/4	5	0562 05 13	10	19	38.5	42.5	0.040

0563 Needle Drain Valve, Male NPT Thread

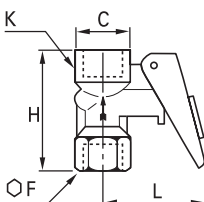

	Brass		C			F	H	H	kg
			NPT1/4	5	0563 05 14	14	28.5	32.5	0.021

0627 Automatic Vent Pressure Gauge Valve, Female BSPP Thread

	Nickel-plated brass, NBR		C		F	H	K	L	kg
			G1/4	0627 00 13	19	43.5	20	40	0.097

Pressure: 10 bar
 This isolating valve is used to connect a pressure gauge to a circuit.
 Resetting the lever isolates and vents the gauge.
 A locking pin can be used to enable the gauge to be fitted permanently.

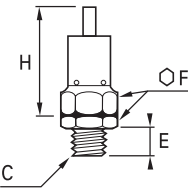
0630 Pressure Relief Valve, Male BSPP Thread



	Brass		C		E	F	H	kg
			G1/4	0630 06 13	9	17	42.5	0.050

This valve is delivered without calibration, but can be adjusted by inserting metal washers into the hexagon (F).

Stainless Steel Needle Valves

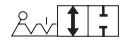
0591 Needle Valve, Female BSPP Thread

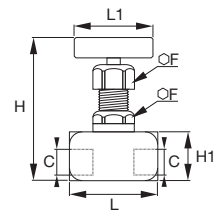

	Stainless steel 316L, PTFE 	C			F	H	H	H1	L	L1	kg	
					min	max						
		G1/8	3	0591 03 10	22	90	99	25	45	48	0.345	
		G1/4	4	0591 04 13	22	90	99	25	50	48	0.356	
		G3/8	5	0591 05 17	22	90	104	30	56	48	0.430	
G1/2	6	0591 06 21	22	90	104	30	62	48	0.483			

Needle and Butterfly Valves
Industrial Valves

Butterfly Valves

In these robust valves, the internal component used to shut off the flow is a segment of a sphere. This allows **frequent operation with very low torque, no fluid retention areas** and therefore excellent mechanical performance.

Product Advantages

Compact & Abrasion-Resistant

- Excellent with abrasive fluids (including solid particles)
- Fluid flow direction marked for greater safety (uni-directional)
- Smooth operation
- Can be easily adapted for use with auxiliary actuators
- More compact than a ball valve with equivalent nominal diameter
- Simple and efficient design for a long service life

- ### Applications
- Painting & Printing
 - Machine Tools
 - Pneumatics
 - Powder Conveyance
 - Plumbing
 - Rubber Industry
 - Petrochemical

Technical Characteristics

Compatible Fluids	Compressed air, industrial gases, water, cutting oils, hydraulic oils, fuel oil, fuel, etc.
Working Pressure	0 to 16 bar
Working Temperature	-20°C to +80°C

Reliable performance is dependent upon the type of fluid conveyed.

Component Materials

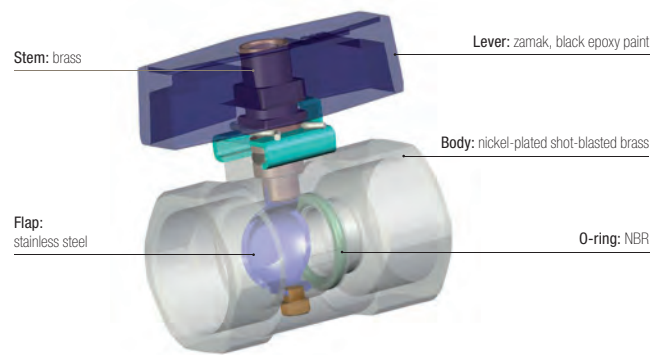

Silicone-free



Regulations

- DI: 97/23/EC (module PED A - diameters greater than 25 mm)
- DI: 2006/42/EC (Machinery Directive)
- DI: 2002/95/EC (RoHS)
- RG: 1907/2006 (REACH)

Butterfly Valves

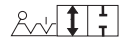
4602 2/2 Butterfly Shut-Off Valve, Female BSPP Thread

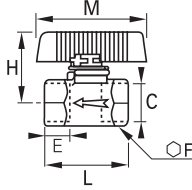

	<p>Nickel-plated brass, NBR</p> 	C	DN		E	F	H	L	M	kg
		G1/4	6	4602 06 13	9	17	35	34	54	0.098
		G3/8	7	4602 07 17	11	22	35	39	54	0.136
		G1/2	10	4602 10 21	12	24	37	42	54	0.140
		G3/4	13	4602 13 27	14	30	40	49	54	0.208
G1	18	4602 18 34	15	41	46	55	54	0.412		
Black epoxy-coated zamak handle										

Axial Valve Range

In-Line Normally Closed

4202..20

FKM Seal
2/2
Page 6-48



4202..30

EPDM Seal
2/2
Page 6-48



In-Line Normally Open

4212..20

FKM Seal
2/2
Page 6-48



4212..30

EPDM Seal
2/2
Page 6-48



In-Line Double-Acting

4222..20

FKM Seal
2/2
Page 6-48



4222..30

EPDM Seal
2/2
Page 6-49



Accessories

4298

Sub-Base
Page 6-49



4298

Solenoid Valve
Page 6-49



4299

Pneumatic Button
Page 6-49



Axial Valves

The Parker Legris axial valve is the only valve to incorporate both the **valve and actuation function**. With pneumatic or electro-pneumatic control, it avoids many of the restrictions associated with traditional actuators.

Product Advantages

Optimisation & Safety

- Very compact: up to 50% smaller than valves with separate actuators
- Simple to install: ready-to-use
- Common sub-base for solenoid control
- Automation of the open/close function
- Operation independent of the upstream and downstream pressure in the circuit

Comprehensive Offer

- Two seal materials for a wider chemical and temperature range
- Pneumatic, electro-pneumatic or dual actuation control
- Three versions: normally closed, normally open and double-acting

Performance

- Full flow: low pressure drop
- Excellent pressure/temperature performance
- Compatible with many industrial fluids



- Applications**
- Flow Control
 - Plastic Injection Moulding
 - Rubber Industry
 - Pneumatics
 - Textile
 - Printing
 - Packaging
 - Robotics

Technical Characteristics

Compatible Fluids	Depending on type of seal – FKM: water, air, oils, greases, etc. – EPDM: hot water, air, steam, etc.
Working Pressure	10 bar max.
Pilot Pressure	NC and NO: 4.2 to 8 bar Double-acting: 3 to 8 bar
Working Temperature	-20°C to +135°C (suffix 20 FKM) -20°C to +120°C (suffix 30 EPDM)

Tightening Torques	Threads	G3/8	G1/2	G3/4	G1	G1¼	G1½	G2
	daN.m	0.15 to 0.25	0.20 to 0.35	0.50 to 0.70	0.50 to 0.70	0.40 to 0.60	0.80 to 1.20	0.80 to 1.20

Reliable performance is dependent upon the type of fluid conveyed, component materials and tubing being used.
Guaranteed for use with a vacuum of 740 mm Hg (97% vacuum).

Flow Curve and Pressure Drop (Kv)

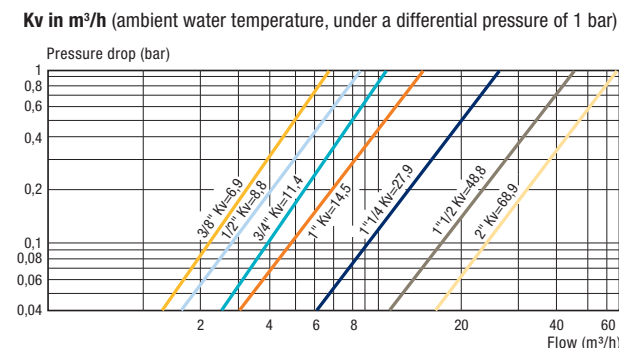

Component Materials

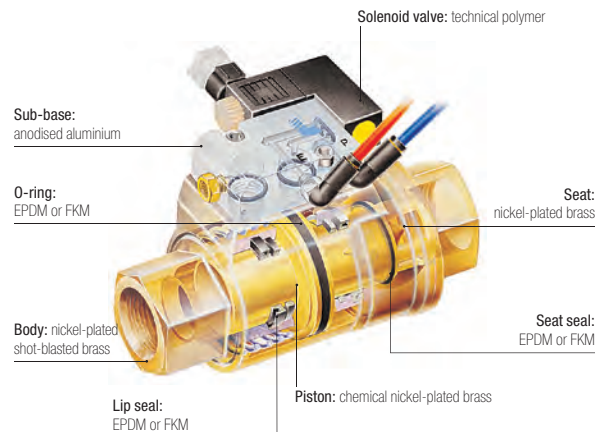

Silicone-free

Regulations

- DI: 97/23/EC (module PED A - diameters greater than 25 mm)
- DI: 2006/42/EC (Machinery Directive)
- DI: 2002/95/EC (RoHS)
- RG: 1907/2006 (REACH)
- DI: 94/9/EC (ATEX) - for pneumatic operation versions

Axial Valves

Operation

Depending on operational requirement, air is passed into the actuation chamber to open or close the valve.

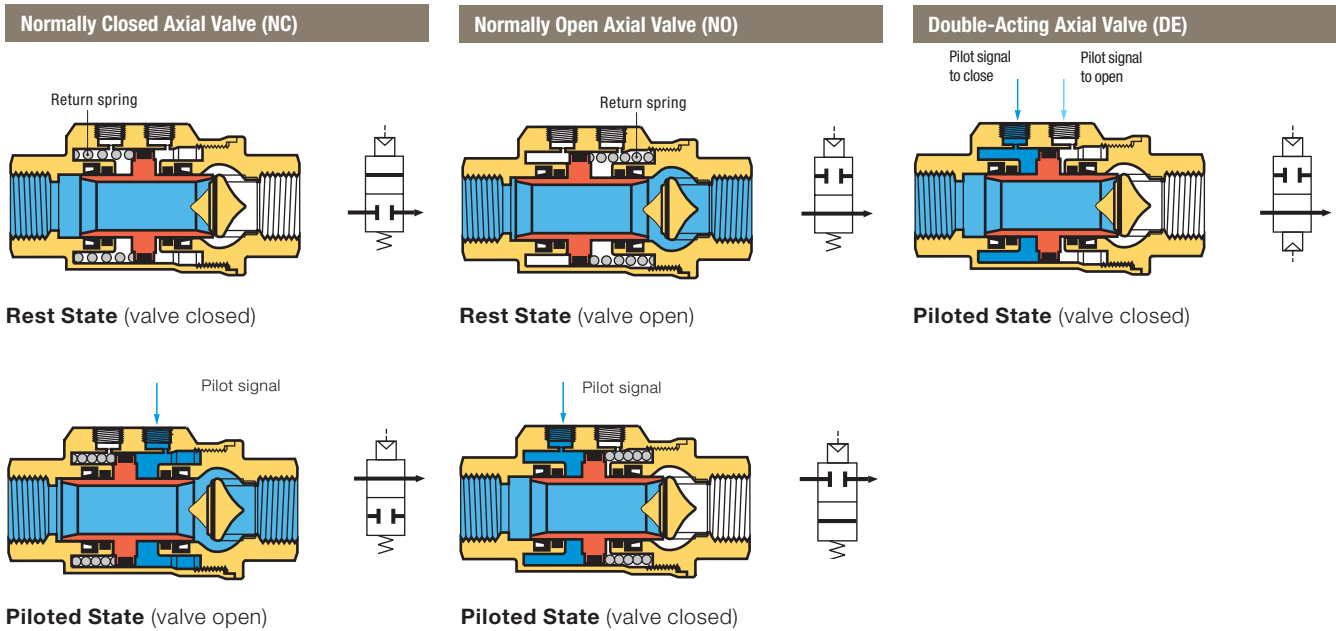

Installation Options

The **Parker Legris** axial valve offers 3 different control methods dependant on the requirements of the installation:

Pneumatic Control

Example: Double-acting axial valve 4222

- local compressed air control
- for repetitive on/off cycles
- remote control where access to the machine is difficult
- for explosive or explosion prevention areas

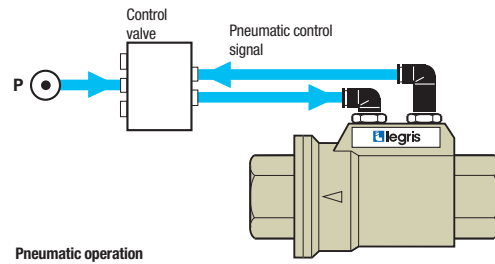

Electro-Pneumatic Control

Example: Normally closed axial valve 4202 + sub-base and Mini-solenoid valve 4298

- for automated industrial systems requiring remote control
- Namur seating plane solenoid valve

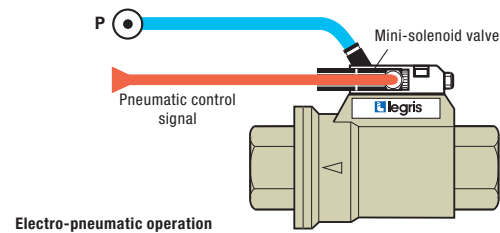

Dual Pneumatic and Electro-Pneumatic Control

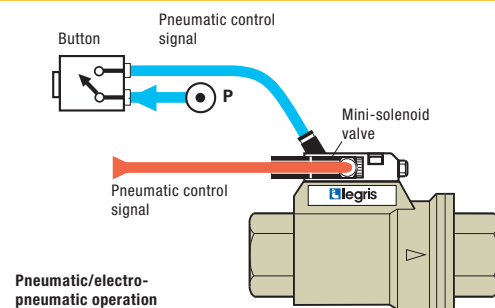

Example: Normally open axial valve 4212 + sub-base and Mini-solenoid valve 4298 + Pneumatic push-button 4299

- dual control structure
- for increased safety: prevents localised operating errors
- Namur seating plane solenoid valve



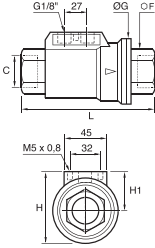

Axial Valves

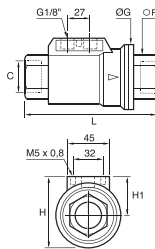

4202..20 Normally Closed Axial Valve with FKM Seal, Female BSPP Thread

	<p>Nickel-plated brass, FKM</p> 	C		F	G	H	H1	L	kg
		G3/8	4202 10 17 20	22	46	54	31	98	0.815
		G1/2	4202 15 21 20	27	52	60	35	112	1.092
		G3/4	4202 20 27 20	33	64	70	38	135	1.624
		G1	4202 25 34 20	41	69	76	41.5	143	2.033
		G1¼	4202 32 42 20*	50	86	91	48	165	3.266
		G1½	4202 40 49 20*	60	96	102	54	180	4.195
		G2	4202 50 48 20*	75	109	115	60.5	207	6.465
<p>Pilot port: G1/8 - Delivered with a silencer *Models with CE marking</p>									

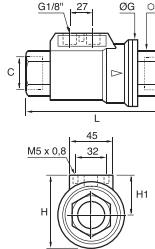

4202..30 Normally Closed Axial Valve with EPDM Seal, Female BSPP Thread

	<p>Nickel-plated brass, EPDM</p> 	C		F	G	H	H1	L	kg
		G3/8	4202 10 17 30	22	46	54	31	98	0.828
		G1/2	4202 15 21 30	27	52	60	35	112	1.098
		G3/4	4202 20 27 30	33	64	70	38	135	1.624
		G1	4202 25 34 30	41	69	76	41.5	143	1.998
		G1¼	4202 32 42 30*	50	86	91	48	165	3.315
		G1½	4202 40 49 30*	60	96	102	54	180	4.195
		G2	4202 50 48 30*	75	109	115	60.5	207	6.360
<p>Pilot port: G1/8 - Delivered with a silencer *Models with CE marking</p>									

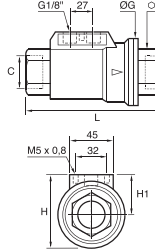

4212..20 Normally Open Axial Valve with FKM Seal, Female BSPP Thread

	<p>Nickel-plated brass, FKM</p> 	C		F	G	H	H1	L	kg
		G3/8	4212 10 17 20	22	46	54	31	98	0.829
		G1/2	4212 15 21 20	27	52	60	35	112	1.100
		G3/4	4212 20 27 20	33	64	70	38	135	1.637
		G1	4212 25 34 20	41	69	76	41.5	143	2.037
		G1¼	4212 32 42 20*	50	86	91	48	165	0.030
		G1½	4212 40 49 20*	60	96	102	54	180	4.188
		G2	4212 50 48 20*	75	109	115	60.5	207	6.555
<p>Pilot port: G1/8 - Delivered with a silencer *Models with CE marking</p>									

4212..30 Normally Open Axial Valve with EPDM seal, Female BSPP Thread

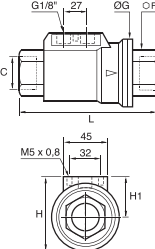

	<p>Nickel-plated brass, EPDM</p> 	C		F	G	H	H1	L	kg
		G3/8	4212 10 17 30	22	46	54	31	98	0.827
		G1/2	4212 15 21 30	27	52	60	35	112	1.152
		G3/4	4212 20 27 30	33	64	70	38	135	1.575
		G1	4212 25 34 30	41	69	76	41.5	143	2.055
		G1¼	4212 32 42 30*	50	86	91	48	165	3.301
		G1½	4212 40 49 30*	60	96	102	54	180	4.775
		G2	4212 50 48 30*	75	109	115	60.5	207	6.360
<p>Pilot port: G1/8 - Delivered with a silencer *Models with CE marking</p>									

4222..20 Double-Acting Axial Valve with FKM Seal, Female BSPP Thread

	<p>Nickel-plated brass, FKM</p> 	C		F	G	H	H1	L	kg
		G3/8	4222 10 17 20	22	46	54	31	98	0.802
		G1/2	4222 15 21 20	27	52	60	35	112	1.063
		G3/4	4222 20 27 20	33	64	70	38	135	1.572
		G1	4222 25 34 20	41	69	76	41.5	143	1.942
		G1¼	4222 32 42 20*	50	86	91	48	165	3.058
		G1½	4222 40 49 20*	60	96	102	54	180	3.995
		G2	4222 50 48 20*	75	109	115	60.5	207	6.275
<p>Pilot port: G1/8 *Models with CE marking</p>									

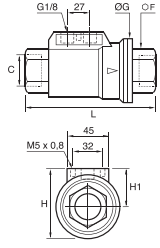

Axial Valves

4222..30 Double Acting Axial Valve with EPDM seal, Female BSPP Thread

	<p>Nickel-plated brass, EPDM</p> 	C		F	G	H	H1	L	kg
		G3/8	4222 10 17 30	22	46	54	31	98	0.832
G1/2	4222 15 21 30	27	52	60	35	112	1.046		
G3/4	4222 20 27 30	33	64	70	38	135	1.662		
G1	4222 25 34 30	41	69	76	41.5	143	1.938		
G1¼	4222 32 42 30*	50	86	91	48	165	3.301		
G1½	4222 40 49 30*	60	96	102	54	180	4.260		
G2	4222 50 48 30*	75	109	115	60.5	207	6.520		

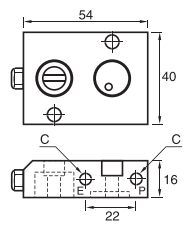

Pilot port: G1/8
Delivered with a silencer
*Models with CE marking

4298 Sub-Base for Solenoid Pilot Valve

	<p>Treated aluminium, NBR</p> 	C		kg
		M5x0.8	4298 00 01	0.095



The sub-base is fitted directly to the axial valve and allows the mounting of a 15x15 solenoid valve.
Supplied with 2 fixing bolts, silencer and seals.

4298 Mini-Solenoid Valve 1W/12VA

	<p>Anodised aluminium</p> 	Voltage		kg
		24V \equiv CC*	4298 01 01	0.052
24V \sim CA**	4298 01 02	0.058		
110V \sim CA**	4298 02 01	0.051		
220V \sim CA**	4298 02 02	0.054		

*Direct current
**Alternating current

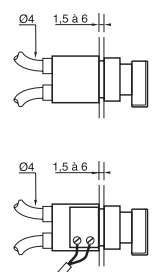
4299 Pneumatic Button/Electro-Pneumatic

	<p>Nickel-plated brass</p> 	Contact		kg
		Standard*	4299 01 01	0.085
With key*	4299 01 02	0.110		
Standard**	4299 02 01	0.102		
With key**	4299 02 02	0.124		

Bulkhead fixing hole diameter: Ø22 mm
*1 pneumatic contact
**1 electro-pneumatic contact
Available upon request only