

IRK. SERIES

STANDARD RECOVERY DIODES

INT-A-pak™ Power Modules

Features

- High voltage
- Electrically isolated base plate
- 3000 V_{RMS} isolating voltage
- Industrial standard package
- Simplified mechanical designs, rapid assembly
- High surge capability
- Large creepage distances
- UL E78996 approved 

165 A
195 A
230 A

Description

These series of INT-A-paks uses high voltage power diodes in two basic configurations. The semiconductors are electrically isolated from the metal base, allowing common heatsinks and compact assemblies to be built. They can be interconnected to form single phase or three phase bridges and the single diode module can be used in conjunction with the thyristor modules as a freewheel diode. These modules are intended for general purpose applications such as battery chargers, welders and plating equipment and where high voltage and high current are required (motor drives, etc.).

Major Ratings and Characteristics

Parameters	IRK.165.. IRK.166..	IRK.195.. IRK.196..	IRK.235.. IRK.236..	Units
I _{F(AV)}	165	195	230	A
@ T _C	100	100	100	°C
I _{F(RMS)}	260	305	360	A
I _{FSM} @ 50Hz	4000	4750	6540	A
@ 60Hz	4200	4980	6850	A
I ² t @ 50Hz	80	113	214	KA ² s
@ 60Hz	73	103	195	KA ² s
I ² √t	1130	1130	2140	KA ² √s
V _{RRM}	upto2000	upto2000	upto2400	V
T _J range	-40 to 150			°C

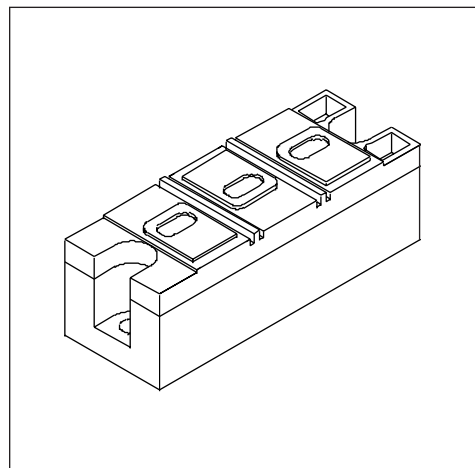

ELECTRICAL SPECIFICATIONS

Voltage Ratings

Type number	Voltage Code	V _{RRM} , Maximum repetitive peak reverse voltage V	V _{RSM} , Maximum non-repetitive peak reverse voltage V	I _{RRM} Max @ 150°C mA
IRK.165- / IRK.166- IRK.195- / IRK.196- IRK.235- / IRK.236-	04	400	500	50
	08	800	900	
	12	1200	1300	
	16	1600	1700	
	20	2000	2100	
IRK.235- / IRK.236-	24	2400	2500	50

Forward Conduction

Parameters	IRK.165 IRK.166	IRK.195 IRK.196	IRK.235 IRK.236	Units	Conditions
I _{F(AV)} Maximum average forward current @ Case temperature	165 100	195 100	230 100	A °C	180° conduction, half sine wave
I _{F(RMS)} Maximum RMS forward current	260	305	360	A	as AC switch
I _{FSM} Maximum peak, one-cycle forward, non-repetitive surge current	4000	4750	6540	A	t = 10ms No voltage
	4200	4980	6850		t = 8.3ms reapplied
	3350	4000	5500		t = 10ms 100% V _{RRM}
	3500	4200	5750		t = 8.3ms reapplied
I ² t Maximum I ² t for fusing	80	113	214	KA ² s	t = 10ms No voltage
	73	103	195		t = 8.3ms reapplied
	56	80	151		t = 10ms 100% V _{RRM}
	52	73	138		t = 8.3ms reapplied
I ² √t Maximum I ² √t for fusing	798	1130	2140	KA ² √s	t = 0.1 to 10ms, no voltage reapplied
V _{F(TO)1} Low level value of threshold voltage	0.70	0.75	0.79	V	(16.7% x π x I _{F(AV)} < I < π x I _{F(AV)}), T _J = T _J max.
V _{F(TO)2} High level value of threshold voltage	0.87	0.86	0.92	V	(I > π x I _{F(AV)}), T _J = T _J max.
r _{t1} Low level forward slope resistance	1.69	0.92	0.64	mΩ	(16.7% x π x I _{F(AV)} < I < π x I _{F(AV)}), T _J = T _J max.
r _{t2} High level forward slope resistance	1.42	0.77	0.49	mΩ	(I > π x I _{F(AV)}), T _J = T _J max.
V _{FM} Maximum forward voltage drop	1.57	1.32	1.26	V	I _{FM} = π x I _{F(AV)} , T _J = T _J max., 180° conduction Av. power = V _{F(TO)} x I _{F(AV)} + r _t x (I _{F(RMS)}) ²

Blocking

Parameter	IRK.165 / .195 / .235 IRK.166 / .196 / .236	Units	Conditions
I _{RRM} Max. peak reverse leakage current	50	mA	T _J = 150°C
V _{INS} RMS isolation voltage	3000	V	50 Hz, circuit to base, all terminals shorted, t = 1 sec

Thermal and Mechanical Specifications

Parameter	IRK.165 / .195 / .235 IRK.166 / .196 / .236	Units	Conditions
T _J Max. junction operating temperature range	-40 to 150	°C	
T _{stg} Max. storage temperature range	-40 to 150	°C	
R _{thJC} Max. thermal resistance, junction to case	0.20 0.20 0.17	K/W	Per junction, DC operation
R _{thCS} Max. thermal resistance, case to heatsink	0.035	K/W	Mounting surface flat, smooth and greased Per module
T Mounting torque ±10% IAP to heatsink busbar to IAP	4 to 6 4 to 6	Nm	A mounting compound is recommended and the torque should be rechecked after a period of 3 hours to allow for the spread of the compound
wt Approximate weight	500 (17.8)	g (oz)	

ΔR Conduction (per Junction)

(The following table shows the increment of thermal resistance R_{thJC} when devices operate at different conduction angles than DC)

Devices	Sinusoidal conduction @ T _J max.					Rectangular conduction @ T _J max.					Units
	180°	120°	90°	60°	30°	180°	120°	90°	60°	30°	
IRK.165, .166	0.016	0.019	0.024	0.035	0.060	0.011	0.019	0.026	0.037	0.060	K/W
IRK.195, .196	0.016	0.019	0.024	0.035	0.060	0.011	0.019	0.026	0.037	0.060	
IRK.235, .236	0.016	0.019	0.025	0.036	0.060	0.012	0.020	0.027	0.037	0.060	

Ordering Information Table

Device Code

IRK	D	23	6	-	24	N
①	②	③	④		⑤	⑥

- 1** - Module type
- 2** - Circuit configuration
- 3** - Current rating: I_{F(AV)} x 10 rounded
- 4** - 5 = option with spacers and longer terminal screws
- 5** 6 = option with standard terminal screws
- 6** - Voltage code: Code x 100 = V_{RRM} (see Voltage Rating Table)
- 7** - None = Standard devices
N = Aluminum nitride substrate

IRK.165, .166, .195, .196, .235, .236 Series

I27096 rev. B 10/99



Outline Table

- All dimensions in millimeters (inches)
- Dimensions are nominal
- Full engineering drawings are available on request
- UL identification number for cathode wire: UL 1385
- UL identification number for package: UL 94V0

For all types	A	B	C	D	E
IRK...5	25 (0.98)	----	----	41 (1.61)	47 (1.85)
IRK...6	23 (0.91)	30 (1.18)	36 (1.42)	----	----

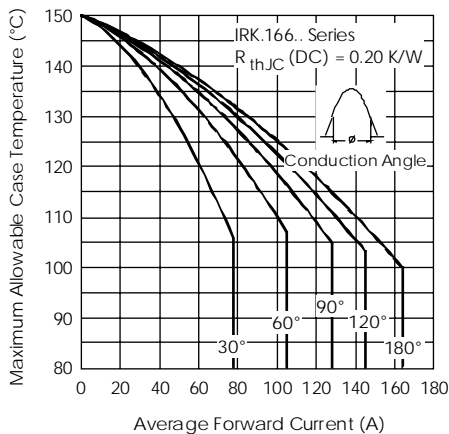

Fig. 1 - Current Ratings Characteristics

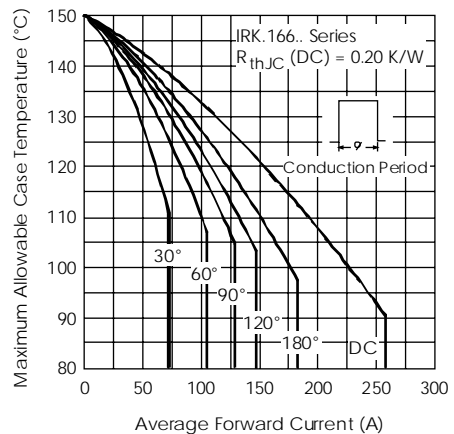

Fig. 2 - Current Ratings Characteristics

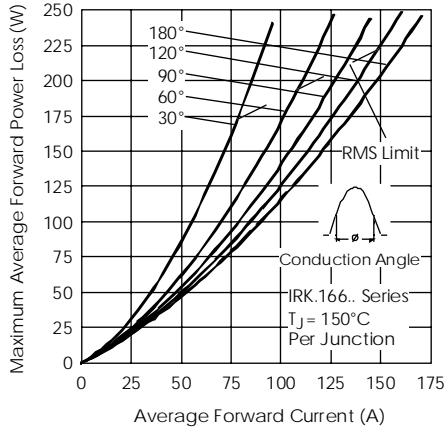

Fig. 3 - Forward Power Loss Characteristics

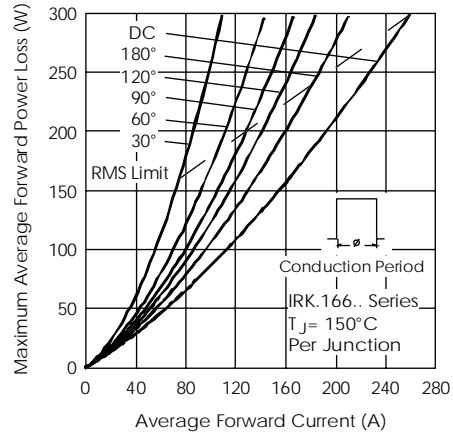

Fig. 4 - Forward Power Loss Characteristics

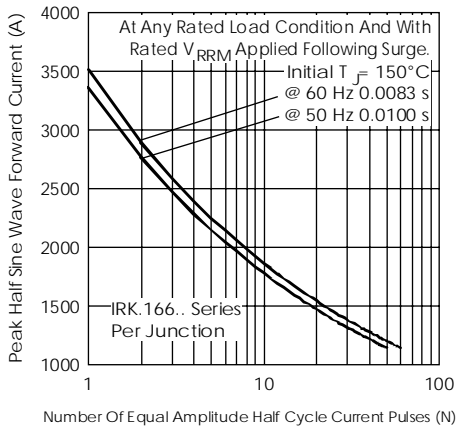

Fig. 5 - Maximum Non-Repetitive Surge Current

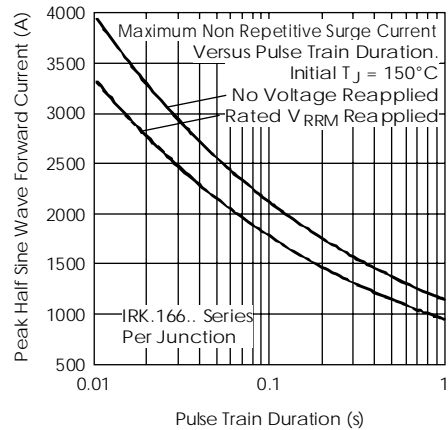

Fig. 6 - Maximum Non-Repetitive Surge Current

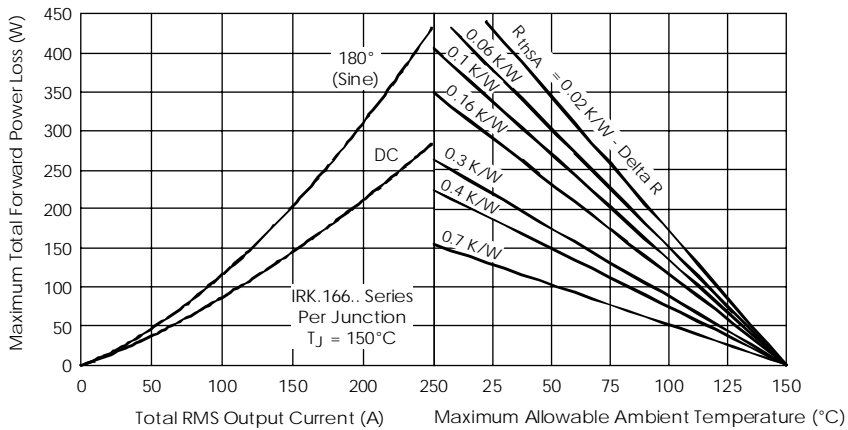

Fig. 7 - Forward Power Loss Characteristics

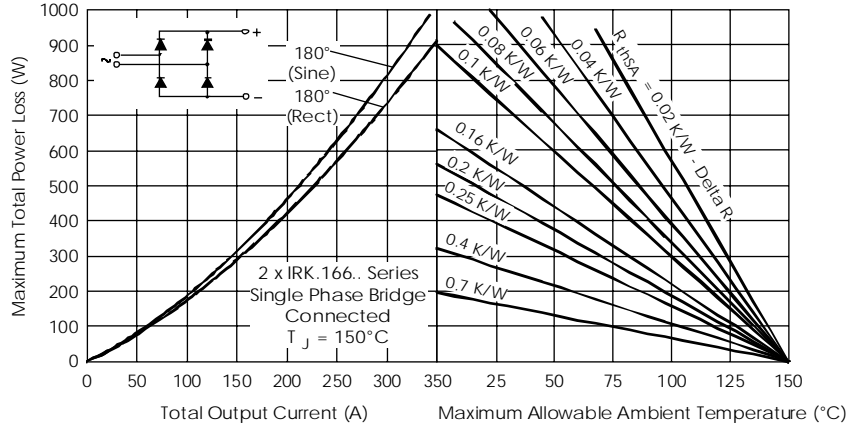

Fig. 8 - Forward Power Loss Characteristics

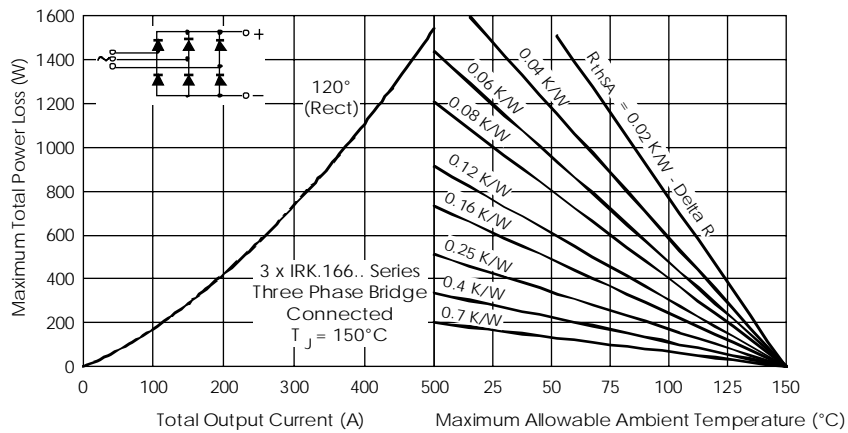

Fig. 9 - Forward Power Loss Characteristics

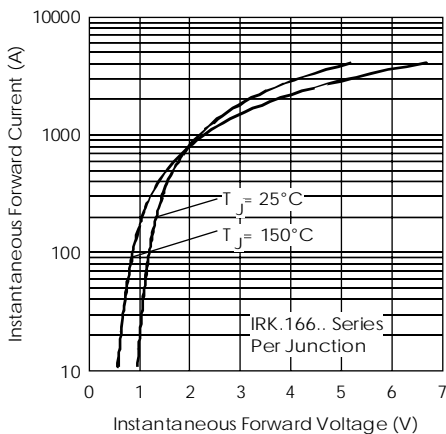

Fig. 10 - Forward Voltage Drop Characteristics

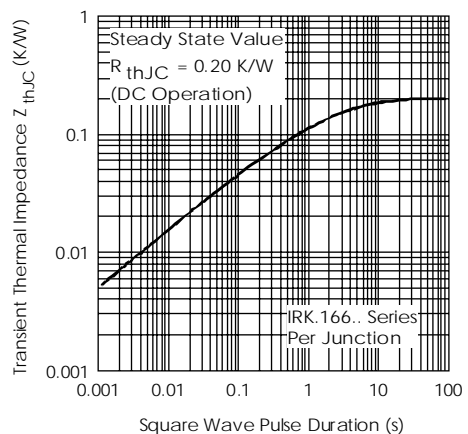

Fig. 11 - Thermal Impedance Z_{thJC} Characteristic

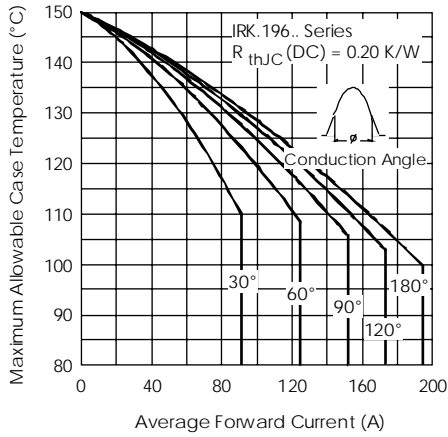

Fig. 12 - Current Ratings Characteristics

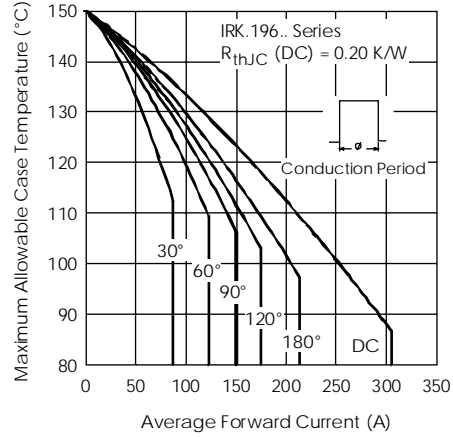

Fig. 13 - Current Ratings Characteristics

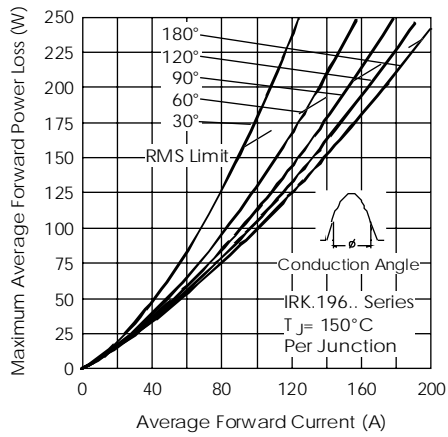

Fig. 14 - Forward Power Loss Characteristics

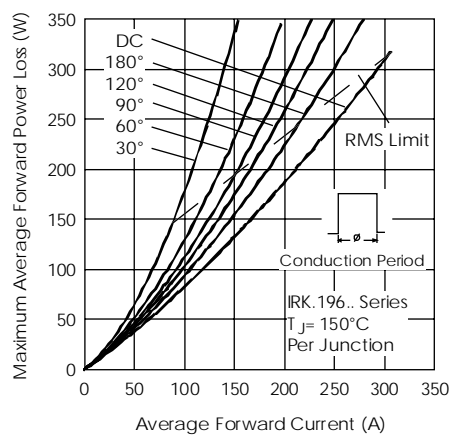

Fig. 15 - Forward Power Loss Characteristics

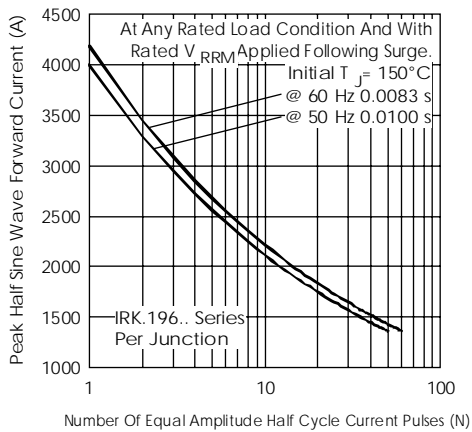

Fig. 16 - Maximum Non-Repetitive Surge Current

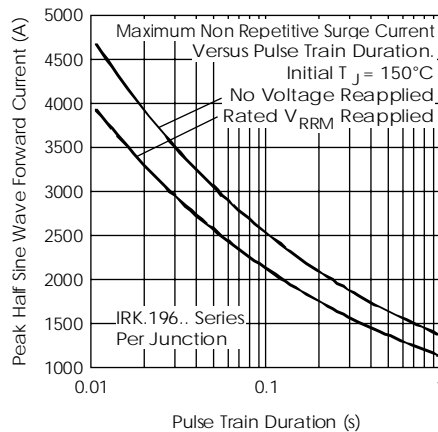

Fig. 17 - Maximum Non-Repetitive Surge Current

IRK.165, .166, .195, .196, .235, .236 Series

I27096 rev. B 10/99

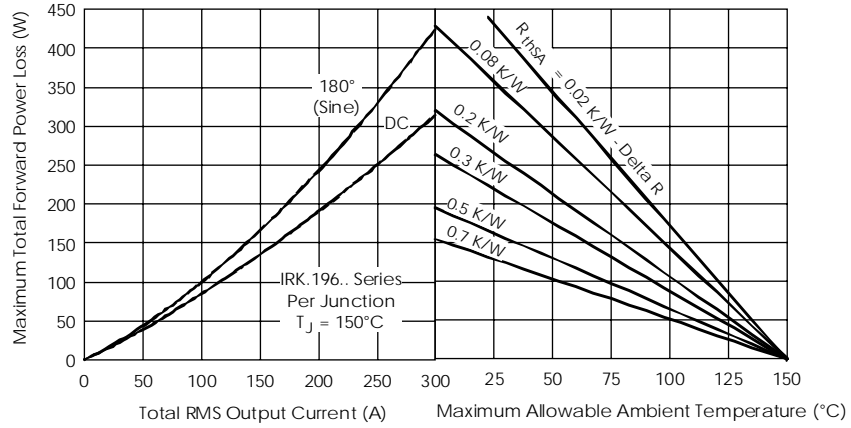

Fig. 18 - Forward Power Loss Characteristics

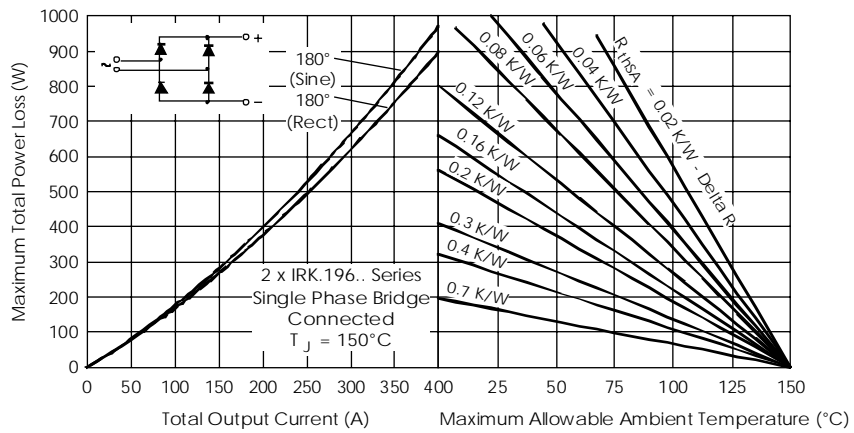

Fig. 19 - Forward Power Loss Characteristics

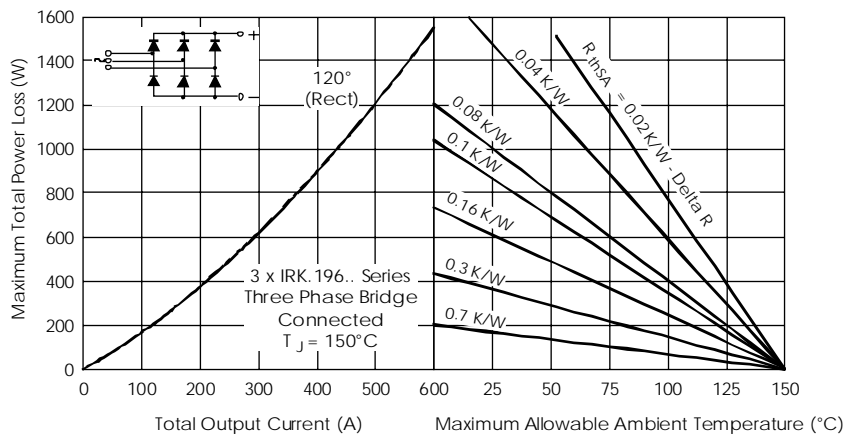

Fig. 20 - Forward Power Loss Characteristics

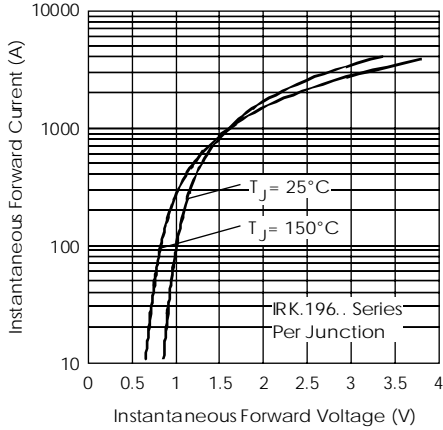

Fig. 21 - Forward Voltage Drop Characteristics

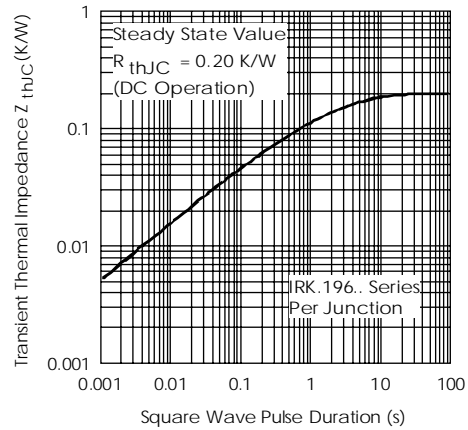

Fig. 22 - Thermal Impedance Z_{thJC} Characteristic

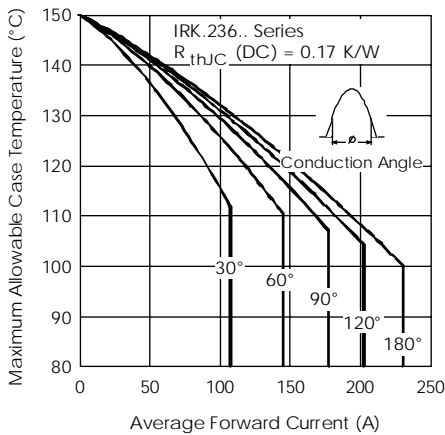

Fig. 23 - Current Ratings Characteristics

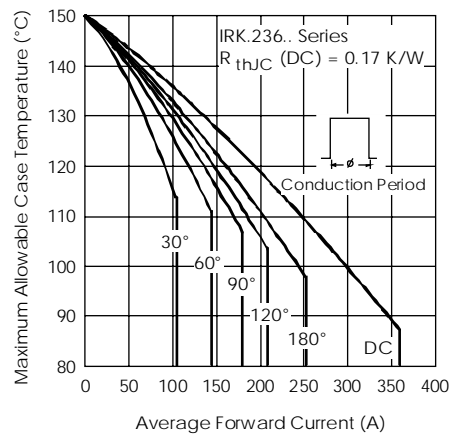

Fig. 24 - Current Ratings Characteristics

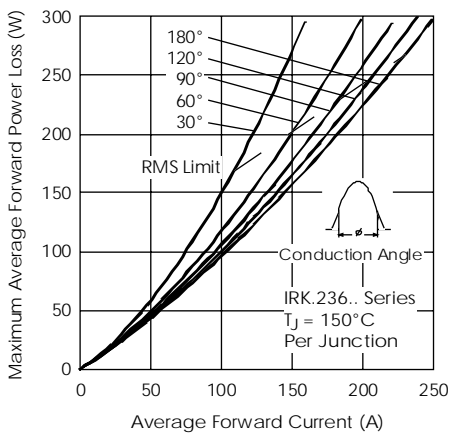

Fig. 25 - Forward Power Loss Characteristics

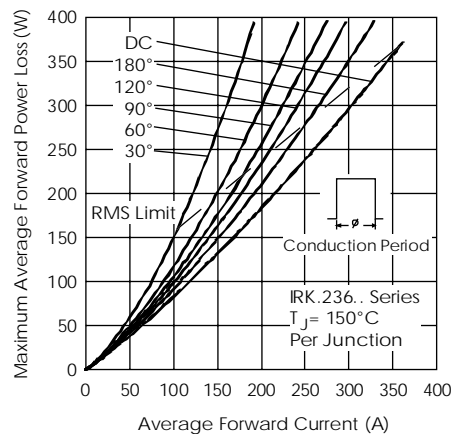

Fig. 26 - Forward Power Loss Characteristics

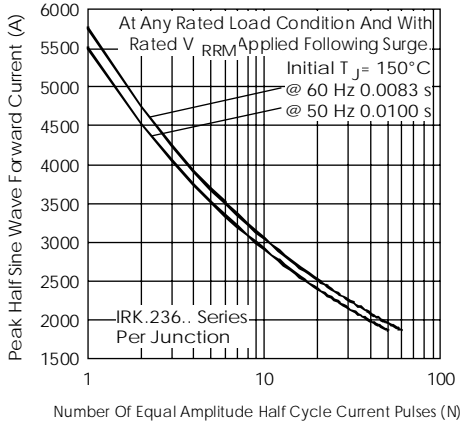

Fig. 27 - Maximum Non-Repetitive Surge Current

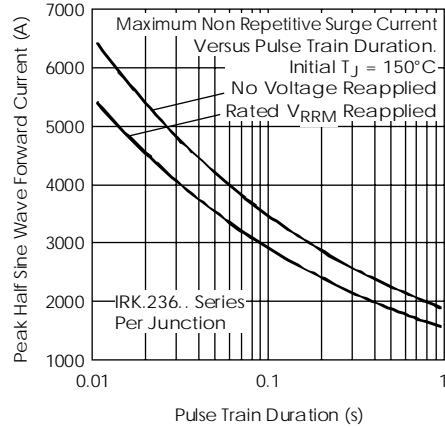

Fig. 28 - Maximum Non-Repetitive Surge Current

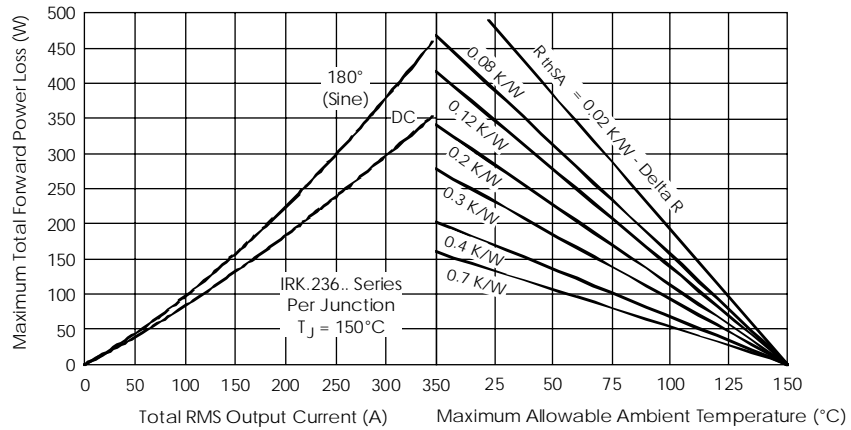

Fig. 29 - Forward Power Loss Characteristics

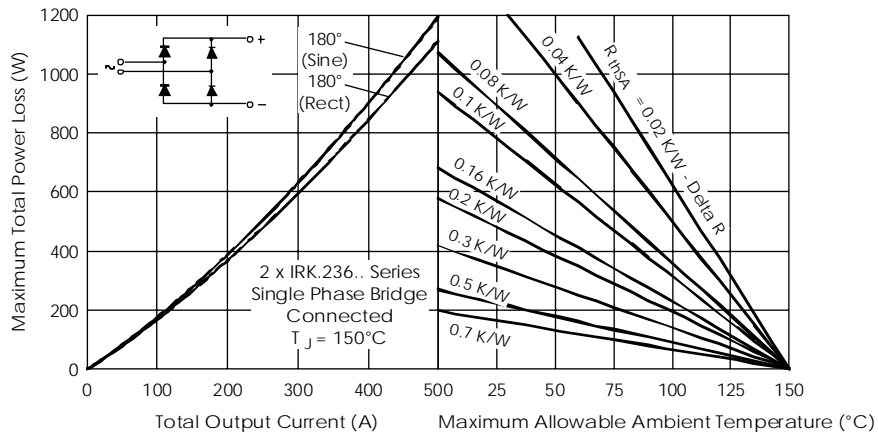

Fig. 30 - Forward Power Loss Characteristics

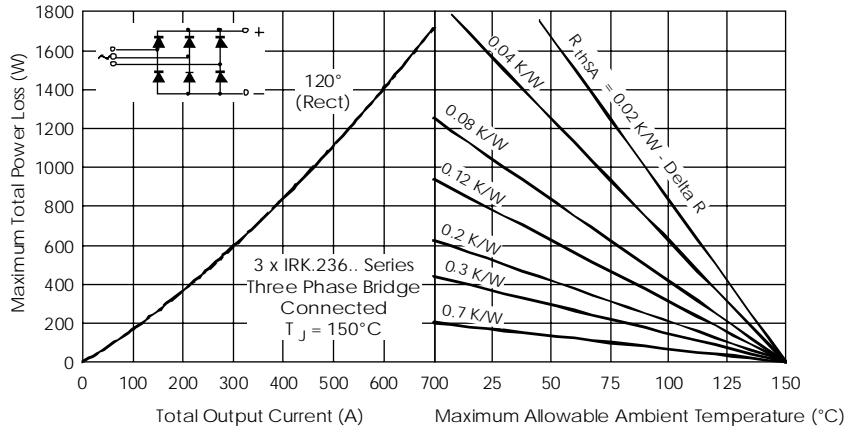

Fig. 31 - Forward Power Loss Characteristics

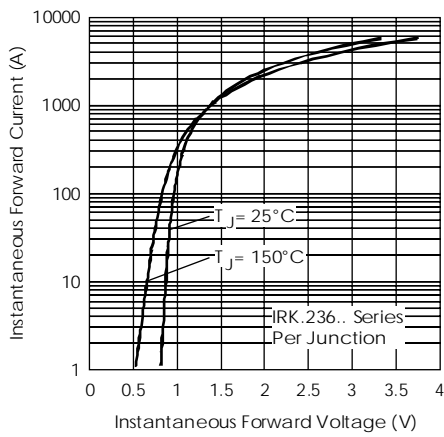

Fig. 32 - Forward Voltage Drop Characteristics

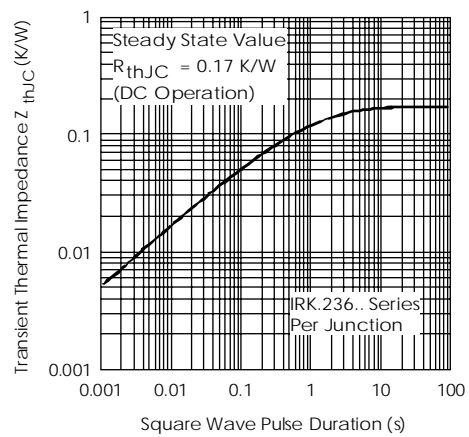

Fig. 33 - Thermal Impedance Z_{thJC} Characteristic